

Intel® 64 and IA-32 Architectures Software Developer's Manual

Volume 2A: Instruction Set Reference, A-M

NOTE: The Intel 64 and IA-32 Architectures Software Developer's Manual consists of five volumes: *Basic Architecture*, Order Number 253665; *Instruction Set Reference A-M*, Order Number 253666; *Instruction Set Reference N-Z*, Order Number 253667; *System Programming Guide, Part 1*, Order Number 253668; *System Programming Guide, Part 2*, Order Number 253669. Refer to all five volumes when evaluating your design needs.

Order Number: 253666-031US
June 2009

INFORMATION IN THIS DOCUMENT IS PROVIDED IN CONNECTION WITH INTEL PRODUCTS. NO LICENSE, EXPRESS OR IMPLIED, BY ESTOPPEL OR OTHERWISE, TO ANY INTELLECTUAL PROPERTY RIGHTS IS GRANTED BY THIS DOCUMENT. EXCEPT AS PROVIDED IN INTEL'S TERMS AND CONDITIONS OF SALE FOR SUCH PRODUCTS, INTEL ASSUMES NO LIABILITY WHATSOEVER AND INTEL DISCLAIMS ANY EXPRESS OR IMPLIED WARRANTY, RELATING TO SALE AND/OR USE OF INTEL PRODUCTS INCLUDING LIABILITY OR WARRANTIES RELATING TO FITNESS FOR A PARTICULAR PURPOSE, MERCHANTABILITY, OR INFRINGEMENT OF ANY PATENT, COPYRIGHT OR OTHER INTELLECTUAL PROPERTY RIGHT.

UNLESS OTHERWISE AGREED IN WRITING BY INTEL, THE INTEL PRODUCTS ARE NOT DESIGNED NOR INTENDED FOR ANY APPLICATION IN WHICH THE FAILURE OF THE INTEL PRODUCT COULD CREATE A SITUATION WHERE PERSONAL INJURY OR DEATH MAY OCCUR.

Intel may make changes to specifications and product descriptions at any time, without notice. Designers must not rely on the absence or characteristics of any features or instructions marked "reserved" or "undefined." Intel reserves these for future definition and shall have no responsibility whatsoever for conflicts or incompatibilities arising from future changes to them. The information here is subject to change without notice. Do not finalize a design with this information.

The Intel® 64 architecture processors may contain design defects or errors known as errata. Current characterized errata are available on request.

Intel® Hyper-Threading Technology requires a computer system with an Intel® processor supporting Hyper-Threading Technology and an Intel® HT Technology enabled chipset, BIOS and operating system. Performance will vary depending on the specific hardware and software you use. For more information, see <http://www.intel.com/technology/hyperthread/index.htm>; including details on which processors support Intel HT Technology.

Intel® Virtualization Technology requires a computer system with an enabled Intel® processor, BIOS, virtual machine monitor (VMM) and for some uses, certain platform software enabled for it. Functionality, performance or other benefits will vary depending on hardware and software configurations. Intel® Virtualization Technology-enabled BIOS and VMM applications are currently in development.

64-bit computing on Intel architecture requires a computer system with a processor, chipset, BIOS, operating system, device drivers and applications enabled for Intel® 64 architecture. Processors will not operate (including 32-bit operation) without an Intel® 64 architecture-enabled BIOS. Performance will vary depending on your hardware and software configurations. Consult with your system vendor for more information.

Enabling Execute Disable Bit functionality requires a PC with a processor with Execute Disable Bit capability and a supporting operating system. Check with your PC manufacturer on whether your system delivers Execute Disable Bit functionality.

Intel, Pentium, Intel Xeon, Intel NetBurst, Intel Core Solo, Intel Core Duo, Intel Core 2 Duo, Intel Core 2 Extreme, Intel Pentium D, Itanium, Intel SpeedStep, MMX, Intel Atom, and VTune are trademarks or registered trademarks of Intel Corporation or its subsidiaries in the United States and other countries.

*Other names and brands may be claimed as the property of others.

Contact your local Intel sales office or your distributor to obtain the latest specifications and before placing your product order.

Copies of documents which have an ordering number and are referenced in this document, or other Intel literature, may be obtained by calling 1-800-548-4725, or by visiting Intel's website at <http://www.intel.com>

Copyright © 1997-2009 Intel Corporation

CONTENTS

PAGE

CHAPTER 1

ABOUT THIS MANUAL

1.1	IA-32 PROCESSORS COVERED IN THIS MANUAL	1-1
1.2	OVERVIEW OF VOLUME 2A AND 2B: INSTRUCTION SET REFERENCE	1-3
1.3	NOTATIONAL CONVENTIONS	1-4
1.3.1	Bit and Byte Order	1-4
1.3.2	Reserved Bits and Software Compatibility	1-5
1.3.3	Instruction Operands	1-5
1.3.4	Hexadecimal and Binary Numbers	1-6
1.3.5	Segmented Addressing	1-6
1.3.6	Exceptions	1-6
1.3.7	A New Syntax for CPUID, CR, and MSR Values	1-7
1.4	RELATED LITERATURE	1-8

CHAPTER 2

INSTRUCTION FORMAT

2.1	INSTRUCTION FORMAT FOR PROTECTED MODE, REAL-ADDRESS MODE, AND VIRTUAL-8086 MODE 2-1	
2.1.1	Instruction Prefixes	2-1
2.1.2	Opcodes	2-3
2.1.3	ModR/M and SIB Bytes	2-4
2.1.4	Displacement and Immediate Bytes	2-4
2.1.5	Addressing-Mode Encoding of ModR/M and SIB Bytes	2-4
2.2	IA-32E MODE	2-9
2.2.1	REX Prefixes	2-9
2.2.1.1	Encoding	2-10
2.2.1.2	More on REX Prefix Fields	2-10
2.2.1.3	Displacement	2-13
2.2.1.4	Direct Memory-Offset MOVs	2-13
2.2.1.5	Immediates	2-14
2.2.1.6	RIP-Relative Addressing	2-14
2.2.1.7	Default 64-Bit Operand Size	2-15
2.2.2	Additional Encodings for Control and Debug Registers	2-15

CHAPTER 3

INSTRUCTION SET REFERENCE, A-M

3.1	INTERPRETING THE INSTRUCTION REFERENCE PAGES	3-1
3.1.1	Instruction Format	3-1
3.1.1.1	Opcode Column in the Instruction Summary Table	3-2
3.1.1.2	Instruction Column in the Opcode Summary Table	3-3
3.1.1.3	64-bit Mode Column in the Instruction Summary Table	3-7
3.1.1.4	Compatibility/Legacy Mode Column in the Instruction Summary Table	3-7
3.1.1.5	Description Column in the Instruction Summary Table	3-7
3.1.1.6	Description Section	3-7

CONTENTS

	PAGE
3.1.1.7	Operation Section..... 3-7
3.1.1.8	Intel® C/C++ Compiler Intrinsic Equivalents Section..... 3-11
3.1.1.9	Flags Affected Section 3-14
3.1.1.10	FPU Flags Affected Section..... 3-14
3.1.1.11	Protected Mode Exceptions Section..... 3-15
3.1.1.12	Real-Address Mode Exceptions Section 3-16
3.1.1.13	Virtual-8086 Mode Exceptions Section..... 3-16
3.1.1.14	Floating-Point Exceptions Section..... 3-16
3.1.1.15	SIMD Floating-Point Exceptions Section 3-17
3.1.1.16	Compatibility Mode Exceptions Section..... 3-17
3.1.1.17	64-Bit Mode Exceptions Section 3-17
3.1.2	Imm8 Control Byte Operation for PCMPSTRI / PCMPSTRM / PCMPISTRI / PCMPISTRM. 3-18
3.1.2.1	General Description 3-18
3.1.2.2	Source Data Format..... 3-19
3.1.2.3	Aggregation Operation..... 3-20
3.1.2.4	Polarity..... 3-21
3.1.2.5	Output Selection..... 3-22
3.1.2.6	Valid/Invalid Override of Comparisons..... 3-22
3.1.2.7	Summary of Im8 Control byte..... 3-23
3.1.2.8	Diagram Comparison and Aggregation Process..... 3-25
3.2	INSTRUCTIONS (A-M)..... 3-25
	AAA—ASCII Adjust After Addition 3-26
	AAD—ASCII Adjust AX Before Division..... 3-28
	AAM—ASCII Adjust AX After Multiply..... 3-30
	AAS—ASCII Adjust AL After Subtraction..... 3-32
	ADC—Add with Carry..... 3-34
	ADD—Add 3-37
	ADDPD—Add Packed Double-Precision Floating-Point Values 3-40
	ADDPS—Add Packed Single-Precision Floating-Point Values 3-43
	ADDSD—Add Scalar Double-Precision Floating-Point Values 3-46
	ADDSS—Add Scalar Single-Precision Floating-Point Values 3-49
	ADDSUBPD—Packed Double-FP Add/Subtract 3-52
	ADDSUBPS—Packed Single-FP Add/Subtract..... 3-56
	AND—Logical AND 3-60
	ANDPD—Bitwise Logical AND of Packed Double-Precision Floating-Point Values... 3-63
	ANDPS—Bitwise Logical AND of Packed Single-Precision Floating-Point Values... 3-65
	ANDNPD—Bitwise Logical AND NOT of Packed Double-Precision Floating-Point Values... 3-67
	ANDNPS—Bitwise Logical AND NOT of Packed Single-Precision Floating-Point Values. 3- 69
	ARPL—Adjust RPL Field of Segment Selector 3-71
	BLENDDP — Blend Packed Double Precision Floating-Point Values 3-73
	BLENDPS — Blend Packed Single Precision Floating-Point Values 3-75
	BLENDVPD — Variable Blend Packed Double Precision Floating-Point Values 3-78
	BLENDVPS — Variable Blend Packed Single Precision Floating-Point Values 3-81
	BOUND—Check Array Index Against Bounds..... 3-84

	PAGE
BSF—Bit Scan Forward	3-87
BSR—Bit Scan Reverse	3-89
BSWAP—Byte Swap	3-91
BT—Bit Test	3-93
BTC—Bit Test and Complement	3-96
BTR—Bit Test and Reset	3-99
BTS—Bit Test and Set	3-102
CALL—Call Procedure	3-105
CBW/CWDE/CDQE—Convert Byte to Word/Convert Word to Doubleword/Convert Doubleword to Quadword	3-123
CLC—Clear Carry Flag	3-124
CLD—Clear Direction Flag	3-125
CLFLUSH—Flush Cache Line	3-126
CLI — Clear Interrupt Flag	3-128
CLTS—Clear Task-Switched Flag in CRO	3-131
CMC—Complement Carry Flag	3-133
CMOVcc—Conditional Move	3-134
CMP—Compare Two Operands	3-141
CMPPD—Compare Packed Double-Precision Floating-Point Values	3-144
CMPPS—Compare Packed Single-Precision Floating-Point Values	3-149
CMPS/CMPSB/CMPSW/CMPSD/CMPSQ—Compare String Operands	3-154
CMPSD—Compare Scalar Double-Precision Floating-Point Values	3-160
CMPS—Compare Scalar Single-Precision Floating-Point Values	3-164
CMPXCHG—Compare and Exchange	3-168
CMPXCHG8B/CMPXCHG16B—Compare and Exchange Bytes	3-171
COMISD—Compare Scalar Ordered Double-Precision Floating-Point Values and Set EFLAGS	3-174
COMISS—Compare Scalar Ordered Single-Precision Floating-Point Values and Set EFLAGS	3-177
CPUID—CPU Identification	3-180
CRC32 — Accumulate CRC32 Value	3-214
CVTDQ2PD—Convert Packed Dword Integers to Packed Double-Precision FP Values .	3-218
CVTDQ2PS—Convert Packed Dword Integers to Packed Single-Precision FP Values .	3-220
CVTPD2DQ—Convert Packed Double-Precision FP Values to Packed Dword Integers .	3-223
CVTPD2PI—Convert Packed Double-Precision FP Values to Packed Dword Integers .	3-226
CVTPD2PS—Convert Packed Double-Precision FP Values to Packed Single-Precision FP Values	3-229
CVTPI2PD—Convert Packed Dword Integers to Packed Double-Precision FP Values .	3-232
CVTPI2PS—Convert Packed Dword Integers to Packed Single-Precision FP Values .	3-235
CVTPS2DQ—Convert Packed Single-Precision FP Values to Packed Dword Integers .	3-238

CVTSP2PD—Convert Packed Single-Precision FP Values to Packed Double-Precision FP Values3-241

CVTPS2PI—Convert Packed Single-Precision FP Values to Packed Dword Integers3-244

CVTSD2SI—Convert Scalar Double-Precision FP Value to Integer3-247

CVTSD2SS—Convert Scalar Double-Precision FP Value to Scalar Single-Precision FP Value.....3-250

CVTSI2SD—Convert Dword Integer to Scalar Double-Precision FP Value3-253

CVTSI2SS—Convert Dword Integer to Scalar Single-Precision FP Value.....3-256

CVTSS2SD—Convert Scalar Single-Precision FP Value to Scalar Double-Precision FP Value.....3-259

CVTSS2SI—Convert Scalar Single-Precision FP Value to Dword Integer.....3-262

CVTTPD2DQ—Convert with Truncation Packed Double-Precision FP Values to Packed Dword Integers.....3-265

CVTTPD2PI—Convert with Truncation Packed Double-Precision FP Values to Packed Dword Integers.....3-268

CVTTPS2DQ—Convert with Truncation Packed Single-Precision FP Values to Packed Dword Integers.....3-271

CVTTPS2PI—Convert with Truncation Packed Single-Precision FP Values to Packed Dword Integers.....3-274

CVTTSD2SI—Convert with Truncation Scalar Double-Precision FP Value to Signed Integer.....3-277

CVTTSS2SI—Convert with Truncation Scalar Single-Precision FP Value to Dword Integer 3-280

CWD/CDQ/CQO—Convert Word to Doubleword/Convert Doubleword to Quadword3-283

DAA—Decimal Adjust AL after Addition.....3-285

DAS—Decimal Adjust AL after Subtraction.....3-287

DEC—Decrement by 13-289

DIV—Unsigned Divide3-292

DIVPD—Divide Packed Double-Precision Floating-Point Values.....3-296

DIVPS—Divide Packed Single-Precision Floating-Point Values.....3-299

DIVSD—Divide Scalar Double-Precision Floating-Point Values.....3-302

DIVSS—Divide Scalar Single-Precision Floating-Point Values.....3-305

DPPD — Dot Product of Packed Double Precision Floating-Point Values3-308

DPPS — Dot Product of Packed Single Precision Floating-Point Values3-311

EMMS—Empty MMX Technology State3-315

ENTER—Make Stack Frame for Procedure Parameters3-317

EXTRACTPS — Extract Packed Single Precision Floating-Point Value.....3-321

F2XM1—Compute 2x-13-324

FABS—Absolute Value3-326

FADD/FADDP/FIADD—Add.....3-328

FBLD—Load Binary Coded Decimal3-332

FBSTP—Store BCD Integer and Pop3-334

FCHS—Change Sign3-337

FCLEX/FNCLEX—Clear Exceptions.....3-339

FCMOVcc—Floating-Point Conditional Move.....3-341

FCOMI/FCOMIP/ FUCOMI/FUCOMIP—Compare Floating Point Values and Set EFLAGS . .3-

347	
FCOS—Cosine	3-350
FDECSTP—Decrement Stack-Top Pointer	3-352
FDIV/FDIVP/FIDIV—Divide	3-354
FDIVR/FDIVRP/FIDIVR—Reverse Divide	3-358
FFREE—Free Floating-Point Register	3-362
FICOM/FICOMP—Compare Integer	3-363
FILD—Load Integer	3-366
FINCSTP—Increment Stack-Top Pointer	3-368
FINIT/FNINIT—Initialize Floating-Point Unit	3-370
FIST/FISTP—Store Integer	3-372
FISTTP—Store Integer with Truncation	3-376
FLD—Load Floating Point Value	3-379
FLD1/FLDL2T/FLDL2E/FLDPI/FLDLG2/FLDLN2/FLDZ—Load Constant	3-382
FLDCW—Load x87 FPU Control Word	3-384
FLDENV—Load x87 FPU Environment	3-386
FMUL/FMULP/FIMUL—Multiply	3-389
FNOP—No Operation	3-393
FPATAN—Partial Arctangent	3-394
FPREM—Partial Remainder	3-397
FPREM1—Partial Remainder	3-400
FPTAN—Partial Tangent	3-403
FRNDINT—Round to Integer	3-406
FRSTOR—Restore x87 FPU State	3-408
FSAVE/FNSAVE—Store x87 FPU State	3-411
FSCALE—Scale	3-415
FSIN—Sine	3-417
FSINCOS—Sine and Cosine	3-419
FSQRT—Square Root	3-422
FST/FSTP—Store Floating Point Value	3-424
FSTCW/FNSTCW—Store x87 FPU Control Word	3-427
FSTENV/FNSTENV—Store x87 FPU Environment	3-430
FSTSW/FNSTSW—Store x87 FPU Status Word	3-433
FSUB/FSUBP/FISUB—Subtract	3-436
FSUBR/FSUBRP/FISUBR—Reverse Subtract	3-440
FTST—TEST	3-444
FUCOM/FUCOMP/FUCOMPP—Unordered Compare Floating Point Values	3-446
FXAM—Examine ModR/M	3-449
FXCH—Exchange Register Contents	3-451
FXRSTOR—Restore x87 FPU, MMX, XMM, and MXCSR State	3-453
FXSAVE—Save x87 FPU, MMX Technology, and SSE State	3-456
FEXTRACT—Extract Exponent and Significand	3-467
FYL2X—Compute $y * \log_2 x$	3-469
FYL2XP1—Compute $y * \log_2(x + 1)$	3-471
HADDPD—Packed Double-FP Horizontal Add	3-473
HADDPS—Packed Single-FP Horizontal Add	3-477
HLT—Halt	3-481

	PAGE
HSUBPD—Packed Double-FP Horizontal Subtract	3-483
HSUBPS—Packed Single-FP Horizontal Subtract	3-487
IDIV—Signed Divide	3-491
IMUL—Signed Multiply	3-495
IN—Input from Port	3-500
INC—Increment by 1	3-502
INS/INSB/INSW/INSD—Input from Port to String	3-505
INSERTPS — Insert Packed Single Precision Floating-Point Value	3-509
INT n/INT0/INT 3—Call to Interrupt Procedure	3-512
INVD—Invalidate Internal Caches	3-527
INVLPG—Invalidate TLB Entry	3-529
IRET/IRETD—Interrupt Return	3-531
Jcc—Jump if Condition Is Met	3-542
JMP—Jump	3-549
LAHF—Load Status Flags into AH Register	3-559
LAR—Load Access Rights Byte	3-561
LDDQU—Load Unaligned Integer 128 Bits	3-565
LDMXCSR—Load MXCSR Register	3-568
LDS/LES/LFS/LGS/LSS—Load Far Pointer	3-570
LEA—Load Effective Address	3-576
LEAVE—High Level Procedure Exit	3-579
LFENCE—Load Fence	3-581
LGDT/LIDT—Load Global/Interrupt Descriptor Table Register	3-582
LLDT—Load Local Descriptor Table Register	3-585
LMSW—Load Machine Status Word	3-588
LOCK—Assert LOCK# Signal Prefix	3-590
LODS/LODSB/LODSW/LODSD/LODSQ—Load String	3-592
LOOP/LOOPcc—Loop According to ECX Counter	3-596
LSL—Load Segment Limit	3-599
LTR—Load Task Register	3-603
MASKMOVDQU—Store Selected Bytes of Double Quadword	3-606
MASKMOVQ—Store Selected Bytes of Quadword	3-609
MAXPD—Return Maximum Packed Double-Precision Floating-Point Values	3-612
MAXPS—Return Maximum Packed Single-Precision Floating-Point Values	3-615
MAXSD—Return Maximum Scalar Double-Precision Floating-Point Value	3-618
MAXSS—Return Maximum Scalar Single-Precision Floating-Point Value	3-621
MFENCE—Memory Fence	3-624
MINPD—Return Minimum Packed Double-Precision Floating-Point Values	3-625
MINPS—Return Minimum Packed Single-Precision Floating-Point Values	3-628
MINSD—Return Minimum Scalar Double-Precision Floating-Point Value	3-631
MINSS—Return Minimum Scalar Single-Precision Floating-Point Value	3-634
MONITOR—Set Up Monitor Address	3-637
MOV—Move	3-640
MOV—Move to/from Control Registers	3-646
MOV—Move to/from Debug Registers	3-649
MOVAPD—Move Aligned Packed Double-Precision Floating-Point Values	3-651
MOVAPS—Move Aligned Packed Single-Precision Floating-Point Values	3-654

	PAGE
MOVBE—Move Data After Swapping Bytes	3-657
MOVD/MOVQ—Move Doubleword/Move Quadword	3-660
MOVDDUP—Move One Double-FP and Duplicate	3-664
MOVDDQA—Move Aligned Double Quadword	3-667
MOVDQU—Move Unaligned Double Quadword	3-669
MOVDQ2Q—Move Quadword from XMM to MMX Technology Register	3-672
MOVHLP— Move Packed Single-Precision Floating-Point Values High to Low ...	3-674
MOVHPD—Move High Packed Double-Precision Floating-Point Value	3-676
MOVHPS—Move High Packed Single-Precision Floating-Point Values	3-679
MOVLHP—Move Packed Single-Precision Floating-Point Values Low to High ...	3-682
MOVLPD—Move Low Packed Double-Precision Floating-Point Value	3-684
MOVLPS—Move Low Packed Single-Precision Floating-Point Values	3-686
MOVMSKPD—Extract Packed Double-Precision Floating-Point Sign Mask	3-689
MOVMSKPS—Extract Packed Single-Precision Floating-Point Sign Mask	3-691
MOVNTDQA — Load Double Quadword Non-Temporal Aligned Hint	3-693
MOVNTDQ—Store Double Quadword Using Non-Temporal Hint	3-696
MOVNTI—Store Doubleword Using Non-Temporal Hint	3-699
MOVNTPD—Store Packed Double-Precision Floating-Point Values Using Non-Temporal Hint	3-701
MOVNTPS—Store Packed Single-Precision Floating-Point Values Using Non-Temporal Hint	3-704
MOVNTQ—Store of Quadword Using Non-Temporal Hint	3-707
MOVQ—Move Quadword	3-710
MOVQ2DQ—Move Quadword from MMX Technology to XMM Register	3-713
MOVSB/MOVSQ—Move Data from String to String	3-715
MOVSD—Move Scalar Double-Precision Floating-Point Value	3-720
MOVSHDUP—Move Packed Single-FP High and Duplicate	3-723
MOVSLDUP—Move Packed Single-FP Low and Duplicate	3-726
MOVSS—Move Scalar Single-Precision Floating-Point Values	3-729
MOVSB/MOVSXD—Move with Sign-Extension	3-732
MOVUPD—Move Unaligned Packed Double-Precision Floating-Point Values	3-734
MOVUPS—Move Unaligned Packed Single-Precision Floating-Point Values	3-737
MOVZX—Move with Zero-Extend	3-740
MPSADBW — Compute Multiple Packed Sums of Absolute Difference	3-742
MUL—Unsigned Multiply	3-746
MULPD—Multiply Packed Double-Precision Floating-Point Values	3-749
MULPS—Multiply Packed Single-Precision Floating-Point Values	3-752
MULSD—Multiply Scalar Double-Precision Floating-Point Values	3-755
MULSS—Multiply Scalar Single-Precision Floating-Point Values	3-758
MWAIT—Monitor Wait	3-761

CHAPTER 4
INSTRUCTION SET REFERENCE, N-Z

4.1	INSTRUCTIONS (N-Z)	4-1
	NEG—Two’s Complement Negation	4-2
	NOP—No Operation	4-5
	NOT—One’s Complement Negation	4-7

	PAGE
OR—Logical Inclusive OR	4-9
ORPD—Bitwise Logical OR of Double-Precision Floating-Point Values	4-12
ORPS—Bitwise Logical OR of Single-Precision Floating-Point Values	4-14
OUT—Output to Port	4-16
OUTS/OUTSB/OUTSW/OUTSD—Output String to Port	4-18
PABSB/PABSW/PABSD — Packed Absolute Value	4-23
PACKSSWB/PACKSSDW—Pack with Signed Saturation	4-27
PACKUSDW — Pack with Unsigned Saturation	4-32
PACKUSWB—Pack with Unsigned Saturation	4-35
PADDB/PADDW/PADDD—Add Packed Integers	4-39
PADDQ—Add Packed Quadword Integers	4-43
PADDSB/PADDSW—Add Packed Signed Integers with Signed Saturation	4-46
PADDUSB/PADDUSW—Add Packed Unsigned Integers with Unsigned Saturation	4-50
PALIGNR — Packed Align Right	4-54
PAND—Logical AND	4-57
PANDN—Logical AND NOT	4-60
PAUSE—Spin Loop Hint	4-63
PAVGB/PAVGW—Average Packed Integers	4-64
PBLENDVB — Variable Blend Packed Bytes	4-68
PBLENDW — Blend Packed Words	4-72
PCMPEQB/PCMPEQW/PCMPEQD— Compare Packed Data for Equal	4-75
PCMPEQW — Compare Packed Qword Data for Equal	4-79
PCMPESTR — Packed Compare Explicit Length Strings, Return Index	4-81
PCMPESTRM — Packed Compare Explicit Length Strings, Return Mask	4-84
PCMPISTR — Packed Compare Implicit Length Strings, Return Index	4-87
PCMPISTRM — Packed Compare Implicit Length Strings, Return Mask	4-90
PCMPGTB/PCMPGTW/PCMPGTD—Compare Packed Signed Integers for Greater Than	4-93
PCMPGTQ — Compare Packed Data for Greater Than	4-98
PEXTRB/PEXTRD/PEXTRQ — Extract Byte/Dword/Qword	4-100
PEXTRW—Extract Word	4-103
PHADDW/PHADDD — Packed Horizontal Add	4-107
PHADDSW — Packed Horizontal Add and Saturate	4-110
PHMINPOSUW — Packed Horizontal Word Minimum	4-113
PHSUBW/PHSUBD — Packed Horizontal Subtract	4-116
PHSUBSW — Packed Horizontal Subtract and Saturate	4-119
PINSRB/PINSRD/PINSRQ — Insert Byte/Dword/Qword	4-122
PINSRW—Insert Word	4-125
PMADDUBSW — Multiply and Add Packed Signed and Unsigned Bytes	4-128
PMADDWD—Multiply and Add Packed Integers	4-131
PMAXSB — Maximum of Packed Signed Byte Integers	4-135
PMAXSD — Maximum of Packed Signed Dword Integers	4-138
PMAXSW—Maximum of Packed Signed Word Integers	4-141
PMAXUB—Maximum of Packed Unsigned Byte Integers	4-144
PMAXUD — Maximum of Packed Unsigned Dword Integers	4-147
PMAXUW — Maximum of Packed Word Integers	4-150
PMINSB — Minimum of Packed Signed Byte Integers	4-153

	PAGE
PMINSD — Minimum of Packed Dword Integers	4-156
PMINSW—Minimum of Packed Signed Word Integers	4-159
PMINUB—Minimum of Packed Unsigned Byte Integers	4-162
PMINUD — Minimum of Packed Dword Integers	4-165
PMINUW — Minimum of Packed Word Integers	4-168
PMOVMKB—Move Byte Mask	4-171
PMOVSX — Packed Move with Sign Extend	4-174
PMOVZX — Packed Move with Zero Extend	4-178
PMULDQ — Multiply Packed Signed Dword Integers	4-182
PMULHRW — Packed Multiply High with Round and Scale	4-184
PMULHUW—Multiply Packed Unsigned Integers and Store High Result	4-187
PMULHW—Multiply Packed Signed Integers and Store High Result	4-191
PMULLD — Multiply Packed Signed Dword Integers and Store Low Result	4-194
PMULLW—Multiply Packed Signed Integers and Store Low Result	4-196
PMULUDQ—Multiply Packed Unsigned Doubleword Integers	4-200
POP—Pop a Value from the Stack	4-203
POPA/POPAD—Pop All General-Purpose Registers	4-210
POPCNT — Return the Count of Number of Bits Set to 1	4-212
POPF/POPFD/POPFDQ—Pop Stack into EFLAGS Register	4-214
POR—Bitwise Logical OR	4-218
PREFETCHH—Prefetch Data Into Caches	4-221
PSADBW—Compute Sum of Absolute Differences	4-223
PSHUFB — Packed Shuffle Bytes	4-227
PSHUFQ—Shuffle Packed Doublewords	4-231
PSHUFHW—Shuffle Packed High Words	4-234
PSHUFLW—Shuffle Packed Low Words	4-237
PSHUFW—Shuffle Packed Words	4-240
PSIGNB/PSIGNW/PSIGND — Packed SIGN	4-242
PSLLDQ—Shift Double Quadword Left Logical	4-247
PSLLW/PSLLD/PSLLQ—Shift Packed Data Left Logical	4-249
PSRAW/PSRAD—Shift Packed Data Right Arithmetic	4-254
PSRLDQ—Shift Double Quadword Right Logical	4-259
PSRLW/PSRLD/PSRLQ—Shift Packed Data Right Logical	4-261
PSUBB/PSUBW/PSUBD—Subtract Packed Integers	4-266
PSUBQ—Subtract Packed Quadword Integers	4-270
PSUBSB/PSUBSW—Subtract Packed Signed Integers with Signed Saturation	4-273
PSUBUSB/PSUBUSW—Subtract Packed Unsigned Integers with Unsigned Saturation	4-277
PTEST- Logical Compare	4-281
PUNPCKHBW/PUNPCKHWD/PUNPCKHDQ/PUNPCKHQDQ— Unpack High Data	4-284
PUNPCKLBW/PUNPCKLWD/PUNPCKLDQ/PUNPCKLQDQ— Unpack Low Data	4-290
PUSH—Push Word, Doubleword or Quadword Onto the Stack	4-295
PUSHA/PUSHAD—Push All General-Purpose Registers	4-300
PUSHF/PUSHFD—Push EFLAGS Register onto the Stack	4-303
PXOR—Logical Exclusive OR	4-306
RCL/RCR/ROL/ROR—Rotate	4-309

	PAGE
RCPSS—Compute Reciprocals of Packed Single-Precision Floating-Point Values	4-316
RCPSS—Compute Reciprocal of Scalar Single-Precision Floating-Point Values	4-319
RDMSR—Read from Model Specific Register	4-322
RDPMC—Read Performance-Monitoring Counters	4-324
RDTSC—Read Time-Stamp Counter	4-329
RDTSCP—Read Time-Stamp Counter and Processor ID	4-331
REP/REPE/REPZ/REPNE/REPZ—Repeat String Operation Prefix	4-333
RET—Return from Procedure	4-338
ROUNDPD — Round Packed Double Precision Floating-Point Values	4-350
ROUNDPS — Round Packed Single Precision Floating-Point Values	4-354
ROUNDSD — Round Scalar Double Precision Floating-Point Values	4-357
ROUNDSS — Round Scalar Single Precision Floating-Point Values	4-360
RSM—Resume from System Management Mode	4-363
RSQRTPS—Compute Reciprocals of Square Roots of Packed Single-Precision Floating-Point Values	4-365
RSQRTPS—Compute Reciprocal of Square Root of Scalar Single-Precision Floating-Point Value	4-368
SAHF—Store AH into Flags	4-371
SAL/SAR/SHL/SHR—Shift	4-373
SBB—Integer Subtraction with Borrow	4-380
SCAS/SCASB/SCASW/SCASD—Scan String	4-384
SETcc—Set Byte on Condition	4-389
SFENCE—Store Fence	4-394
SGDT—Store Global Descriptor Table Register	4-395
SHLD—Double Precision Shift Left	4-398
SHRD—Double Precision Shift Right	4-401
SHUFPS—Shuffle Packed Double-Precision Floating-Point Values	4-404
SHUFPS—Shuffle Packed Single-Precision Floating-Point Values	4-407
SIDT—Store Interrupt Descriptor Table Register	4-410
SLDT—Store Local Descriptor Table Register	4-413
SMSW—Store Machine Status Word	4-415
SQRTPS—Compute Square Roots of Packed Single-Precision Floating-Point Values	4-421
SQRTPS—Compute Square Root of Scalar Double-Precision Floating-Point Value	4-424
SQRTPS—Compute Square Root of Scalar Single-Precision Floating-Point Value	4-427
STC—Set Carry Flag	4-430
STD—Set Direction Flag	4-431
STI—Set Interrupt Flag	4-432
STMXCSR—Store MXCSR Register State	4-435
STOS/STOSB/STOSW/STOSD/STOSQ—Store String	4-437
STR—Store Task Register	4-441
SUB—Subtract	4-443
SUBPD—Subtract Packed Double-Precision Floating-Point Values	4-446
SUBPS—Subtract Packed Single-Precision Floating-Point Values	4-449
SUBSD—Subtract Scalar Double-Precision Floating-Point Values	4-452
SUBSS—Subtract Scalar Single-Precision Floating-Point Values	4-455
SWAPGS—Swap GS Base Register	4-458

	PAGE
SYSCALL—Fast System Call	4-460
SYSENTER—Fast System Call	4-462
SYSEXIT—Fast Return from Fast System Call	4-466
SYSRET—Return From Fast System Call	4-470
TEST—Logical Compare	4-472
UCOMISD—Unordered Compare Scalar Double-Precision Floating-Point Values and Set EFLAGS	4-475
UCOMISS—Unordered Compare Scalar Single-Precision Floating-Point Values and Set EFLAGS	4-478
UD2—Undefined Instruction	4-481
UNPCKHPD—Unpack and Interleave High Packed Double-Precision Floating-Point Values 4-482	
UNPCKHPS—Unpack and Interleave High Packed Single-Precision Floating-Point Values 4-485	
UNPCKLPD—Unpack and Interleave Low Packed Double-Precision Floating-Point Values 4-488	
UNPCKLPS—Unpack and Interleave Low Packed Single-Precision Floating-Point Values 4-491	
VERR/VERW—Verify a Segment for Reading or Writing	4-494
WAIT/FWAIT—Wait	4-497
WBINVD—Write Back and Invalidate Cache	4-499
WRMSR—Write to Model Specific Register	4-501
XADD—Exchange and Add	4-503
XCHG—Exchange Register/Memory with Register	4-506
XGETBV—Get Value of Extended Control Register	4-509
XLAT/XLATB—Table Look-up Translation	4-511
XOR—Logical Exclusive OR	4-513
XORPD—Bitwise Logical XOR for Double-Precision Floating-Point Values	4-516
XORPS—Bitwise Logical XOR for Single-Precision Floating-Point Values	4-518
XRSTOR—Restore Processor Extended States	4-520
XSAVE—Save Processor Extended States	4-525
XSETBV—Set Extended Control Register	4-529

CHAPTER 5

VMX INSTRUCTION REFERENCE

5.1	OVERVIEW	5-1
5.2	CONVENTIONS	5-2
5.3	VMX INSTRUCTIONS	5-3
	INVEPT—Invalidate Translations Derived from EPT	5-4
	INVVPID—Invalidate Translations Based on VPID	5-7
	VMCALL—Call to VM Monitor	5-11
	VMCLEAR—Clear Virtual-Machine Control Structure	5-13
	VMLAUNCH/VMRESUME—Launch/Resume Virtual Machine	5-16
	VMPTRLD—Load Pointer to Virtual-Machine Control Structure	5-19
	VMPTRST—Store Pointer to Virtual-Machine Control Structure	5-22
	VMREAD—Read Field from Virtual-Machine Control Structure	5-24
	VMRESUME—Resume Virtual Machine	5-26

CONTENTS

	PAGE
VMWRITE—Write Field to Virtual-Machine Control Structure	5-27
VMXOFF—Leave VMX Operation	5-29
VMXON—Enter VMX Operation	5-31
5.4 VM INSTRUCTION ERROR NUMBERS	5-34

**CHAPTER 6
SAFER MODE EXTENSIONS REFERENCE**

6.1 OVERVIEW	6-1
6.2 SMX FUNCTIONALITY	6-1
6.2.1 Detecting and Enabling SMX	6-2
6.2.2 SMX Instruction Summary	6-3
6.2.2.1 GETSEC[CAPABILITIES]	6-3
6.2.2.2 GETSEC[ENTERACCS]	6-4
6.2.2.3 GETSEC[EXITAC]	6-4
6.2.2.4 GETSEC[SENER]	6-4
6.2.2.5 GETSEC[SEXIT]	6-5
6.2.2.6 GETSEC[PARAMETERS]	6-5
6.2.2.7 GETSEC[SMCTRL]	6-5
6.2.2.8 GETSEC[WAKEUP]	6-6
6.2.3 Measured Environment and SMX	6-6
6.3 GETSEC LEAF FUNCTIONS	6-7
GETSEC[CAPABILITIES] - Report the SMX Capabilities	6-9
GETSEC[ENTERACCS] - Execute Authenticated Chipset Code	6-12
GETSEC[EXITAC]—Exit Authenticated Code Execution Mode	6-23
GETSEC[SENER]—Enter a Measured Environment	6-27
GETSEC[SEXIT]—Exit Measured Environment	6-39
GETSEC[PARAMETERS]—Report the SMX Parameters	6-43
GETSEC[SMCTRL]—SMX Mode Control	6-48
GETSEC[WAKEUP]—Wake up sleeping processors in measured environment	6-51

**APPENDIX A
OPCODE MAP**

A.1 USING OPCODE TABLES	A-1
A.2 KEY TO ABBREVIATIONS	A-2
A.2.1 Codes for Addressing Method	A-2
A.2.2 Codes for Operand Type	A-3
A.2.3 Register Codes	A-4
A.2.4 Opcode Look-up Examples for One, Two, and Three-Byte Opcodes	A-4
A.2.4.1 One-Byte Opcode Instructions	A-4
A.2.4.2 Two-Byte Opcode Instructions	A-5
A.2.4.3 Three-Byte Opcode Instructions	A-6
A.2.5 Superscripts Utilized in Opcode Tables	A-7
A.3 ONE, TWO, AND THREE-BYTE OPCODE MAPS	A-8
A.4 OPCODE EXTENSIONS FOR ONE-BYTE AND TWO-BYTE OPCODES	A-20
A.4.1 Opcode Look-up Examples Using Opcode Extensions	A-20
A.4.2 Opcode Extension Tables	A-21

	PAGE
A.5	ESCAPE OPCODE INSTRUCTIONS A-23
A.5.1	Opcode Look-up Examples for Escape Instruction Opcodes.....A-23
A.5.2	Escape Opcode Instruction TablesA-23
A.5.2.1	Escape Opcodes with D8 as First ByteA-24
A.5.2.2	Escape Opcodes with D9 as First ByteA-25
A.5.2.3	Escape Opcodes with DA as First ByteA-26
A.5.2.4	Escape Opcodes with DB as First ByteA-27
A.5.2.5	Escape Opcodes with DC as First ByteA-28
A.5.2.6	Escape Opcodes with DD as First ByteA-29
A.5.2.7	Escape Opcodes with DE as First ByteA-30
A.5.2.8	Escape Opcodes with DF As First ByteA-31

APPENDIX B

INSTRUCTION FORMATS AND ENCODINGS

B.1	MACHINE INSTRUCTION FORMAT..... B-1
B.1.1	Legacy Prefixes B-2
B.1.2	REX Prefixes B-2
B.1.3	Opcode Fields B-2
B.1.4	Special Fields..... B-2
B.1.4.1	Reg Field (reg) for Non-64-Bit Modes B-3
B.1.4.2	Reg Field (reg) for 64-Bit Mode..... B-4
B.1.4.3	Encoding of Operand Size (w) Bit B-5
B.1.4.4	Sign-Extend (s) Bit B-5
B.1.4.5	Segment Register (sreg) Field B-6
B.1.4.6	Special-Purpose Register (eee) Field B-6
B.1.4.7	Condition Test (ttn) Field..... B-7
B.1.4.8	Direction (d) Bit B-8
B.1.5	Other Notes..... B-9
B.2	GENERAL-PURPOSE INSTRUCTION FORMATS AND ENCODINGS FOR NON-64-BIT MODES B-9
B.2.1	General Purpose Instruction Formats and Encodings for 64-Bit Mode..... B-24
B.3	PENTIUM® PROCESSOR FAMILY INSTRUCTION FORMATS AND ENCODINGS..... B-53
B.4	64-BIT MODE INSTRUCTION ENCODINGS FOR SIMD INSTRUCTION EXTENSIONS..... B-54
B.5	MMX INSTRUCTION FORMATS AND ENCODINGS..... B-55
B.5.1	Granularity Field (gg) B-55
B.5.2	MMX Technology and General-Purpose Register Fields (mmxreg and reg)..... B-55
B.5.3	MMX Instruction Formats and Encodings Table B-55
B.6	PROCESSOR EXTENDED STATE INSTRUCTION FORMATS AND ENCODINGS..... B-59
B.7	P6 FAMILY INSTRUCTION FORMATS AND ENCODINGS B-59
B.8	SSE INSTRUCTION FORMATS AND ENCODINGS B-60
B.9	SSE2 INSTRUCTION FORMATS AND ENCODINGS..... B-69
B.9.1	Granularity Field (gg) B-69
B.10	SSE3 FORMATS AND ENCODINGS TABLE..... B-86
B.11	SSSE3 FORMATS AND ENCODING TABLE..... B-88
B.12	SPECIAL ENCODINGS FOR 64-BIT MODE..... B-92
B.13	SSE4.1 FORMATS AND ENCODING TABLE..... B-96
B.14	SSE4.2 FORMATS AND ENCODING TABLE..... B-104

CONTENTS

	PAGE
B.15 FLOATING-POINT INSTRUCTION FORMATS AND ENCODINGS	B-106
B.16 VMX INSTRUCTIONS	B-112
B.17 SMX INSTRUCTIONS	B-114

APPENDIX C

INTEL® C/C++ COMPILER INTRINSICS AND FUNCTIONAL EQUIVALENTS

C.1 SIMPLE INTRINSICS	C-2
C.2 COMPOSITE INTRINSICS	C-16

FIGURES

Figure 1-1. Bit and Byte Order	1-4
Figure 1-2. Syntax for CPUID, CR, and MSR Data Presentation	1-8
Figure 2-1. Intel 64 and IA-32 Architectures Instruction Format	2-1
Figure 2-2. Table Interpretation of ModR/M Byte (C8H)	2-5
Figure 2-3. Prefix Ordering in 64-bit Mode	2-9
Figure 2-4. Memory Addressing Without an SIB Byte; REX.X Not Used	2-11
Figure 2-5. Register-Register Addressing (No Memory Operand); REX.X Not Used	2-11
Figure 2-6. Memory Addressing with a SIB Byte	2-12
Figure 2-7. Register Operand Coded in Opcode Byte; REX.X & REX.R Not Used	2-12
Figure 3-1. Bit Offset for BIT[RAX, 21]	3-10
Figure 3-2. Memory Bit Indexing	3-11
Figure 3-3. Operation of PCMPSTRx and PCMPSTRx	3-25
Figure 3-4. ADDSUBPD—Packed Double-FP Add/Subtract	3-52
Figure 3-5. ADDSUBPS—Packed Single-FP Add/Subtract	3-56
Figure 3-6. Version Information Returned by CPUID in EAX	3-191
Figure 3-7. Feature Information Returned in the ECX Register	3-193
Figure 3-8. Feature Information Returned in the EDX Register	3-196
Figure 3-9. Determination of Support for the Processor Brand String	3-206
Figure 3-10. Algorithm for Extracting Maximum Processor Frequency	3-208
Figure 3-11. HADDPD—Packed Double-FP Horizontal Add	3-473
Figure 3-12. HADDPS—Packed Single-FP Horizontal Add	3-477
Figure 3-13. HSUBPD—Packed Double-FP Horizontal Subtract	3-483
Figure 3-14. HSUBPS—Packed Single-FP Horizontal Subtract	3-488
Figure 3-15. MOVDDUP—Move One Double-FP and Duplicate	3-664
Figure 3-16. MOVSHDUP—Move Packed Single-FP High and Duplicate	3-723
Figure 3-17. MOVSLDUP—Move Packed Single-FP Low and Duplicate	3-726
Figure 4-1. Operation of the PACKSSDW Instruction Using 64-bit Operands	4-27
Figure 4-2. PMADDWD Execution Model Using 64-bit Operands	4-132
Figure 4-3. PMULHUW and PMULHW Instruction Operation Using 64-bit Operands	4-187
Figure 4-4. PMULLU Instruction Operation Using 64-bit Operands	4-196
Figure 4-5. PSADBW Instruction Operation Using 64-bit Operands	4-224
Figure 4-6. PSHUB with 64-Bit Operands	4-228
Figure 4-7. PSHUFD Instruction Operation	4-231
Figure 4-8. PSLLW, PSLLD, and PSLLQ Instruction Operation Using 64-bit Operand	4-250
Figure 4-9. PSRAW and PSRAD Instruction Operation Using a 64-bit Operand	4-255
Figure 4-10. PSRLW, PSRLD, and PSRLQ Instruction Operation Using 64-bit Operand	4-262

	PAGE
Figure 4-11. PUNPCKHBW Instruction Operation Using 64-bit Operands	4-285
Figure 4-12. PUNPCKLBW Instruction Operation Using 64-bit Operands	4-290
Figure 4-13. Bit Control Fields of Immediate Byte for ROUNDxx Instruction	4-350
Figure 4-14. SHUFPD Shuffle Operation	4-404
Figure 4-15. SHUFPS Shuffle Operation	4-407
Figure 4-16. UNPCKHPD Instruction High Unpack and Interleave Operation	4-482
Figure 4-17. UNPCKHPS Instruction High Unpack and Interleave Operation	4-485
Figure 4-18. UNPCKLPD Instruction Low Unpack and Interleave Operation	4-488
Figure 4-19. UNPCKLPS Instruction Low Unpack and Interleave Operation	4-491
Figure 5-1. INVEPT Descriptor	5-4
Figure 5-2. INVVPID Descriptor	5-8
Figure A-1. ModR/M Byte nnn Field (Bits 5, 4, and 3)	A-20
Figure B-1. General Machine Instruction Format	B-1

TABLES

Table 2-1. 16-Bit Addressing Forms with the ModR/M Byte	2-6
Table 2-2. 32-Bit Addressing Forms with the ModR/M Byte	2-7
Table 2-3. 32-Bit Addressing Forms with the SIB Byte	2-8
Table 2-4. REX Prefix Fields [BITS: 0100WRXB]	2-11
Table 2-5. Special Cases of REX Encodings	2-13
Table 2-6. Direct Memory Offset Form of MOV	2-14
Table 2-7. RIP-Relative Addressing	2-15
Table 3-1. Register Codes Associated With +rb, +rw, +rd, +ro	3-2
Table 3-2. Range of Bit Positions Specified by Bit Offset Operands	3-11
Table 3-3. Intel 64 and IA-32 General Exceptions	3-15
Table 3-5. SIMD Floating-Point Exceptions	3-17
Table 3-4. x87 FPU Floating-Point Exceptions	3-17
Table 3-6. Source Data Format	3-19
Table 3-7. Aggregation Operation	3-20
Table 3-8. Aggregation Operation	3-21
Table 3-9. Polarity	3-22
Table 3-10. Output Selection	3-22
Table 3-11. Output Selection	3-22
Table 3-12. Comparison Result for Each Element Pair BoolRes[i,j]	3-23
Table 3-13. Summary of Imm8 Control Byte	3-23
Table 3-14. Decision Table for CLI Results	3-128
Table 3-15. Comparison Predicate for CMPPD and CMPPS Instructions	3-144
Table 3-16. Pseudo-Op and CMPPD Implementation	3-145
Table 3-17. Pseudo-Ops and CMPPS	3-150
Table 3-18. Pseudo-Ops and CMPSD	3-160
Table 3-19. Pseudo-Ops and CMPSS	3-165
Table 3-20. Information Returned by CPUID Instruction	3-181
Table 3-21. Highest CPUID Source Operand for Intel 64 and IA-32 Processors	3-190
Table 3-22. Processor Type Field	3-191
Table 3-23. Feature Information Returned in the ECX Register	3-193
Table 3-24. More on Feature Information Returned in the EDX Register	3-197

CONTENTS

	PAGE
Table 3-25. Encoding of CPUID Leaf 2 Descriptors	3-200
Table 3-26. Processor Brand String Returned with Pentium 4 Processor	3-206
Table 3-27. Mapping of Brand Indices; and Intel 64 and IA-32 Processor Brand Strings	3-209
Table 3-28. DIV Action	3-293
Table 3-29. Results Obtained from F2XM1	3-324
Table 3-30. Results Obtained from FABS	3-326
Table 3-31. FADD/FADDP/FIADD Results	3-329
Table 3-32. FBSTP Results	3-334
Table 3-33. FCHS Results	3-337
Table 3-34. FCOM/FCOMP/FCOMPP Results	3-343
Table 3-35. FCOMI/FCOMIP/ FUCOMI/FUCOMIP Results	3-347
Table 3-36. FCOS Results	3-350
Table 3-37. FDIV/FDIVP/FIDIV Results	3-355
Table 3-38. FDIVR/FDIVRP/FIDIVR Results	3-359
Table 3-39. FICOM/FICOMP Results	3-363
Table 3-40. FIST/FISTP Results	3-372
Table 3-41. FISTTP Results	3-376
Table 3-42. FMUL/FMULP/FIMUL Results	3-390
Table 3-43. FPATAN Results	3-395
Table 3-44. FPREM Results	3-397
Table 3-45. FPREM1 Results	3-400
Table 3-46. FPTAN Results	3-403
Table 3-47. FSCALE Results	3-415
Table 3-48. FSIN Results	3-417
Table 3-49. FSINCOS Results	3-419
Table 3-50. FSQRT Results	3-422
Table 3-51. FSUB/FSUBP/FISUB Results	3-437
Table 3-52. FSUBR/FSUBRP/FISUBR Results	3-441
Table 3-53. FTST Results	3-444
Table 3-54. FUCOM/FUCOMP/FUCOMPP Results	3-446
Table 3-55. FXAM Results	3-449
Table 3-56. Non-64-bit-Mode Layout of FXSAVE and FXRSTOR Memory Region	3-456
Table 3-57. Field Definitions	3-458
Table 3-58. Recreating FSAVE Format	3-460
Table 3-59. Layout of the 64-bit-mode FXSAVE Map with Promoted OperandSize	3-461
Table 3-60. Layout of the 64-bit-mode FXSAVE Map with Default OperandSize	3-462
Table 3-61. FYL2X Results	3-469
Table 3-62. FYL2XP1 Results	3-471
Table 3-63. IDIV Results	3-492
Table 3-64. Decision Table	3-513
Table 3-65. Segment and Gate Types	3-562
Table 3-66. Non-64-bit Mode LEA Operation with Address and Operand Size Attributes	3-576
Table 3-67. 64-bit Mode LEA Operation with Address and Operand Size Attributes	3-577

Table 3-68.	Segment and Gate Descriptor Types.....	3-600
Table 3-69.	MUL Results.....	3-746
Table 3-70.	MWAIT Extension Register (ECX).....	3-762
Table 3-71.	MWAIT Hints Register (EAX).....	3-763
Table 4-1.	Recommended Multi-Byte Sequence of NOP Instruction.....	4-5
Table 4-2.	Valid General and Special Purpose Performance Counter Index Range for RDPMC. 4-325	
Table 4-3.	Repeat Prefixes.....	4-336
Table 4-4.	Rounding Modes and Encoding of Rounding Control (RC) Field.....	4-351
Table 4-5.	Decision Table for STI Results.....	4-432
Table 4-6.	SWAPGS Operation Parameters.....	4-458
Table 4-7.	MSRs Used By the SYSENTER and SYSEXIT Instructions.....	4-462
Table 4-8.	General Layout of XSAVE/XRSTOR Save Area.....	4-520
Table 4-9.	XSAVE.HEADER Layout.....	4-521
Table 4-10.	Processor Supplied Init Values XRSTOR May Use.....	4-521
Table 4-11.	Reserved Bit Checking and XRSTOR.....	4-522
Table 4-12.	XSAVE Save Area Layout for x87 FPU and SSE State.....	4-526
Table 5-1.	VM-Instruction Error Numbers.....	5-34
Table 6-1.	Layout of IA32_FEATURE_CONTROL.....	6-2
Table 6-2.	GETSEC Leaf Functions.....	6-3
Table 6-3.	Getsec Capability Result Encoding (EBX = 0).....	6-9
Table 6-4.	Register State Initialization after GETSEC[ENTERACCS].....	6-15
Table 6-5.	IA32_MISC_ENALBES MSR Initialization by ENTERACCS and SENTER.....	6-17
Table 6-6.	Register State Initialization after GETSEC[SENDER] and GETSEC[WAKEUP].....	6-31
Table 6-7.	SMX Reporting Parameters Format.....	6-43
Table 6-8.	External Memory Types Using Parameter 3.....	6-45
Table 6-9.	Default Parameter Values.....	6-46
Table 6-10.	Supported Actions for GETSEC[SMCTRL(0)].....	6-49
Table 6-11.	RPL MVM JOIN Data Structure.....	6-51
Table A-1.	Superscripts Utilized in Opcode Tables.....	A-7
Table A-2.	One-byte Opcode Map: (00H — F7H) *.....	A-10
Table A-3.	Two-byte Opcode Map: 00H — 77H (First Byte is 0FH) *.....	A-12
Table A-4.	Three-byte Opcode Map: 00H — F7H (First Two Bytes are 0F 38H) *.....	A-16
Table A-5.	Three-byte Opcode Map: 00H — F7H (First two bytes are 0F 3AH) *.....	A-18
Table A-6.	Opcode Extensions for One- and Two-byte Opcodes by Group Number *.....	A-21
Table A-7.	D8 Opcode Map When ModR/M Byte is Within 00H to BFH *.....	A-24
Table A-8.	D8 Opcode Map When ModR/M Byte is Outside 00H to BFH *.....	A-24
Table A-9.	D9 Opcode Map When ModR/M Byte is Within 00H to BFH *.....	A-25
Table A-10.	D9 Opcode Map When ModR/M Byte is Outside 00H to BFH *.....	A-25
Table A-11.	DA Opcode Map When ModR/M Byte is Within 00H to BFH *.....	A-26
Table A-12.	DA Opcode Map When ModR/M Byte is Outside 00H to BFH *.....	A-26
Table A-13.	DB Opcode Map When ModR/M Byte is Within 00H to BFH *.....	A-27
Table A-14.	DB Opcode Map When ModR/M Byte is Outside 00H to BFH *.....	A-27
Table A-15.	DC Opcode Map When ModR/M Byte is Within 00H to BFH *.....	A-28
Table A-16.	DC Opcode Map When ModR/M Byte is Outside 00H to BFH *.....	A-28
Table A-17.	DD Opcode Map When ModR/M Byte is Within 00H to BFH *.....	A-29
Table A-18.	DD Opcode Map When ModR/M Byte is Outside 00H to BFH *.....	A-29

CONTENTS

PAGE

Table A-19. DE Opcode Map When ModR/M Byte is Within 00H to BFH * A-30

Table A-20. DE Opcode Map When ModR/M Byte is Outside 00H to BFH * A-30

Table A-21. DF Opcode Map When ModR/M Byte is Within 00H to BFH * A-31

Table A-22. DF Opcode Map When ModR/M Byte is Outside 00H to BFH * A-31

Table B-1. Special Fields Within Instruction Encodings B-3

Table B-2. Encoding of reg Field When w Field is Not Present in Instruction. B-3

Table B-4. Encoding of reg Field When w Field is Not Present in Instruction. B-4

Table B-3. Encoding of reg Field When w Field is Present in Instruction. B-4

Table B-5. Encoding of reg Field When w Field is Present in Instruction. B-5

Table B-6. Encoding of Operand Size (w) Bit B-5

Table B-7. Encoding of Sign-Extend (s) Bit B-6

Table B-8. Encoding of the Segment Register (sreg) Field. B-6

Table B-9. Encoding of Special-Purpose Register (eee) Field B-7

Table B-11. Encoding of Operation Direction (d) Bit B-8

Table B-10. Encoding of Conditional Test (ttn) Field. B-8

Table B-12. Notes on Instruction Encoding B-9

Table B-13. General Purpose Instruction Formats and Encodings
for Non-64-Bit ModesB-9

Table B-14. Special Symbols. B-24

Table B-15. General Purpose Instruction Formats and Encodings
for 64-Bit ModeB-24

Table B-16. Pentium Processor Family Instruction Formats and Encodings,
Non-64-Bit ModesB-53

Table B-17. Pentium Processor Family Instruction Formats and Encodings, 64-Bit Mode B-54

Table B-18. Encoding of Granularity of Data Field (gg) B-55

Table B-19. MMX Instruction Formats and Encodings B-55

Table B-20. Formats and Encodings of XSAVE/XRSTOR/XGETBV/XSETBV Instructions B-59

Table B-21. Formats and Encodings of P6 Family Instructions B-59

Table B-22. Formats and Encodings of SSE Floating-Point Instructions. B-61

Table B-23. Formats and Encodings of SSE Integer Instructions B-67

Table B-24. Format and Encoding of SSE Cacheability & Memory Ordering Instructions B-68

Table B-25. Encoding of Granularity of Data Field (gg) B-69

Table B-26. Formats and Encodings of SSE2 Floating-Point Instructions B-70

Table B-27. Formats and Encodings of SSE2 Integer Instructions B-78

Table B-28. Format and Encoding of SSE2 Cacheability Instructions B-85

Table B-29. Formats and Encodings of SSE3 Floating-Point Instructions B-86

Table B-30. Formats and Encodings for SSE3 Event Management Instructions B-87

Table B-31. Formats and Encodings for SSE3 Integer and Move Instructions B-87

Table B-32. Formats and Encodings for SSSE3 Instructions B-88

Table B-33. Special Case Instructions Promoted Using REX.W B-92

Table B-34. Encodings of SSE4.1 instructions B-96

Table B-35. Encodings of SSE4.2 instructions B-104

Table B-36. General Floating-Point Instruction Formats B-106

Table B-37. Floating-Point Instruction Formats and Encodings B-107

Table B-38. Encodings for VMX Instructions. B-112

Table B-39. Encodings for SMX Instructions B-114

Table C-1. Simple Intrinsics C-3

Table C-2. Composite IntrinsicC-16

CHAPTER 1

ABOUT THIS MANUAL

The *Intel® 64 and IA-32 Architectures Software Developer's Manual, Volumes 2A & 2B: Instruction Set Reference* (order numbers 253666 and 253667) are part of a set that describes the architecture and programming environment of all Intel 64 and IA-32 architecture processors. Other volumes in this set are:

- The *Intel® 64 and IA-32 Architectures Software Developer's Manual, Volume 1: Basic Architecture* (Order Number 253665).
- The *Intel® 64 and IA-32 Architectures Software Developer's Manual, Volumes 3A & 3B: System Programming Guide* (order numbers 253668 and 253669).

The *Intel® 64 and IA-32 Architectures Software Developer's Manual, Volume 1*, describes the basic architecture and programming environment of Intel 64 and IA-32 processors. The *Intel® 64 and IA-32 Architectures Software Developer's Manual, Volumes 2A & 2B*, describe the instruction set of the processor and the opcode structure. These volumes apply to application programmers and to programmers who write operating systems or executives. The *Intel® 64 and IA-32 Architectures Software Developer's Manual, Volumes 3A & 3B*, describe the operating-system support environment of Intel 64 and IA-32 processors. These volumes target operating-system and BIOS designers. In addition, the *Intel® 64 and IA-32 Architectures Software Developer's Manual, Volume 3B*, addresses the programming environment for classes of software that host operating systems.

1.1 IA-32 PROCESSORS COVERED IN THIS MANUAL

This manual set includes information pertaining primarily to the most recent Intel 64 and IA-32 processors, which include:

- Pentium® processors
- P6 family processors
- Pentium® 4 processors
- Pentium® M processors
- Intel® Xeon® processors
- Pentium® D processors
- Pentium® processor Extreme Editions
- 64-bit Intel® Xeon® processors
- Intel® Core™ Duo processor
- Intel® Core™ Solo processor
- Dual-Core Intel® Xeon® processor LV

ABOUT THIS MANUAL

- Intel® Core™2 Duo processor
- Intel® Core™2 Quad processor Q6000 series
- Intel® Xeon® processor 3000, 3200 series
- Intel® Xeon® processor 5000 series
- Intel® Xeon® processor 5100, 5300 series
- Intel® Core™2 Extreme processor X7000 and X6800 series
- Intel® Core™2 Extreme QX6000 series
- Intel® Xeon® processor 7100 series
- Intel® Pentium® Dual-Core processor
- Intel® Xeon® processor 7200, 7300 series
- Intel® Xeon® processor 5200, 5400, 7400 series
- Intel® Core™2 Extreme processor QX9000 and X9000 series
- Intel® Core™2 Quad processor Q9000 series
- Intel® Core™2 Duo processor E8000, T9000 series
- Intel® Atom™ processor family
- Intel® Core™i7 processor

P6 family processors are IA-32 processors based on the P6 family microarchitecture. This includes the Pentium® Pro, Pentium® II, Pentium® III, and Pentium® III Xeon® processors.

The Pentium® 4, Pentium® D, and Pentium® processor Extreme Editions are based on the Intel NetBurst® microarchitecture. Most early Intel® Xeon® processors are based on the Intel NetBurst® microarchitecture. Intel Xeon processor 5000, 7100 series are based on the Intel NetBurst® microarchitecture.

The Intel® Core™ Duo, Intel® Core™ Solo and dual-core Intel® Xeon® processor LV are based on an improved Pentium® M processor microarchitecture.

The Intel® Xeon® processor 3000, 3200, 5100, 5300, 7200, and 7300 series, Intel® Pentium® dual-core, Intel® Core™2 Duo, Intel® Core™2 Quad, and Intel® Core™2 Extreme processors are based on Intel® Core™ microarchitecture.

The Intel® Xeon® processor 5200, 5400, 7400 series, Intel® Core™2 Quad processor Q9000 series, and Intel® Core™2 Extreme processors QX9000, X9000 series, Intel® Core™2 processor E8000 series are based on Enhanced Intel® Core™ microarchitecture.

The Intel® Atom™ processor family is based on the Intel® Atom™ microarchitecture and supports Intel 64 architecture.

The Intel® Core™i7 processor is based on the Intel® Microarchitecture (Nehalem) and supports Intel 64 architecture.

P6 family, Pentium® M, Intel® Core™ Solo, Intel® Core™ Duo processors, dual-core Intel® Xeon® processor LV, and early generations of Pentium 4 and Intel Xeon

processors support IA-32 architecture. The Intel® Atom™ processor Z5xx series support IA-32 architecture.

The Intel® Xeon® processor 3000, 3200, 5000, 5100, 5200, 5300, 5400, 7100, 7200, 7300, 7400 series, Intel® Core™2 Duo, Intel® Core™2 Extreme, Intel® Core™2 Quad processors, Pentium® D processors, Pentium® Dual-Core processor, newer generations of Pentium 4 and Intel Xeon processor family support Intel® 64 architecture.

IA-32 architecture is the instruction set architecture and programming environment for Intel's 32-bit microprocessors.

Intel® 64 architecture is the instruction set architecture and programming environment which is the superset of Intel's 32-bit and 64-bit architectures. It is compatible with the IA-32 architecture.

1.2 OVERVIEW OF VOLUME 2A AND 2B: INSTRUCTION SET REFERENCE

A description of *Intel® 64 and IA-32 Architectures Software Developer's Manual, Volumes 2A & 2B*, content follows:

Chapter 1 — About This Manual. Gives an overview of all five volumes of the *Intel® 64 and IA-32 Architectures Software Developer's Manual*. It also describes the notational conventions in these manuals and lists related Intel® manuals and documentation of interest to programmers and hardware designers.

Chapter 2 — Instruction Format. Describes the machine-level instruction format used for all IA-32 instructions and gives the allowable encodings of prefixes, the operand-identifier byte (ModR/M byte), the addressing-mode specifier byte (SIB byte), and the displacement and immediate bytes.

Chapter 3 — Instruction Set Reference, A-M. Describes Intel 64 and IA-32 instructions in detail, including an algorithmic description of operations, the effect on flags, the effect of operand- and address-size attributes, and the exceptions that may be generated. The instructions are arranged in alphabetical order. General-purpose, x87 FPU, Intel MMX™ technology, SSE/SSE2/SSE3/SSSE3/SSE4 extensions, and system instructions are included.

Chapter 4 — Instruction Set Reference, N-Z. Continues the description of Intel 64 and IA-32 instructions started in Chapter 3. It provides the balance of the alphabetized list of instructions and starts *Intel® 64 and IA-32 Architectures Software Developer's Manual, Volume 2B*.

Chapter 5 — VMX Instruction Reference. Describes the virtual-machine extensions (VMX). VMX is intended for a system executive to support virtualization of processor hardware and a system software layer acting as a host to multiple guest software environments.

Chapter 6— Safer Mode Extensions Reference. Describes the safer mode extensions (SMX). SMX is intended for a system executive to support launching a measured environment in a platform where the identity of the software controlling the platform hardware can be measured for the purpose of making trust decisions.

Appendix A — Opcode Map. Gives an opcode map for the IA-32 instruction set.

Appendix B — Instruction Formats and Encodings. Gives the binary encoding of each form of each IA-32 instruction.

Appendix C — Intel® C/C++ Compiler Intrinsics and Functional Equivalents. Lists the Intel® C/C++ compiler intrinsics and their assembly code equivalents for each of the IA-32 MMX and SSE/SSE2/SSE3 instructions.

1.3 NOTATIONAL CONVENTIONS

This manual uses specific notation for data-structure formats, for symbolic representation of instructions, and for hexadecimal and binary numbers. A review of this notation makes the manual easier to read.

1.3.1 Bit and Byte Order

In illustrations of data structures in memory, smaller addresses appear toward the bottom of the figure; addresses increase toward the top. Bit positions are numbered from right to left. The numerical value of a set bit is equal to two raised to the power of the bit position. IA-32 processors are “little endian” machines; this means the bytes of a word are numbered starting from the least significant byte. Figure 1-1 illustrates these conventions.

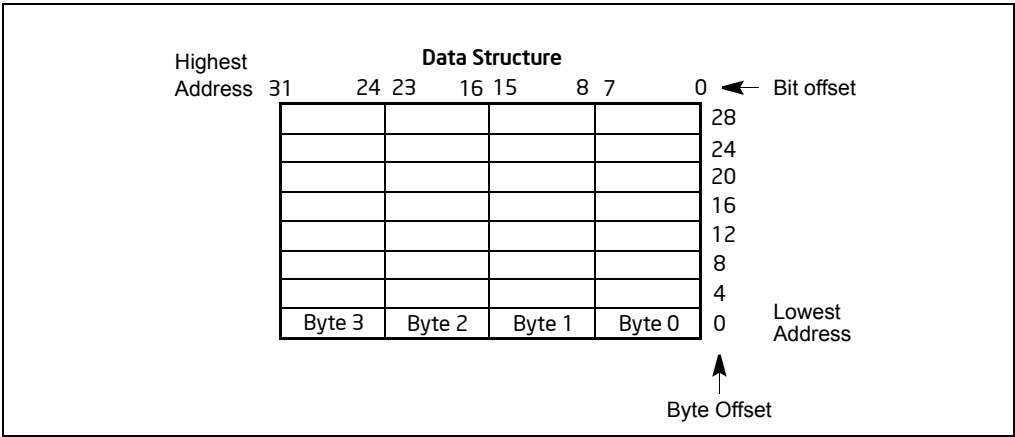

Figure 1-1. Bit and Byte Order

1.3.2 Reserved Bits and Software Compatibility

In many register and memory layout descriptions, certain bits are marked as **reserved**. When bits are marked as reserved, it is essential for compatibility with future processors that software treat these bits as having a future, though unknown, effect. The behavior of reserved bits should be regarded as not only undefined, but unpredictable. Software should follow these guidelines in dealing with reserved bits:

- Do not depend on the states of any reserved bits when testing the values of registers which contain such bits. Mask out the reserved bits before testing.
- Do not depend on the states of any reserved bits when storing to memory or to a register.
- Do not depend on the ability to retain information written into any reserved bits.
- When loading a register, always load the reserved bits with the values indicated in the documentation, if any, or reload them with values previously read from the same register.

NOTE

Avoid any software dependence upon the state of reserved bits in IA-32 registers. Depending upon the values of reserved register bits will make software dependent upon the unspecified manner in which the processor handles these bits. Programs that depend upon reserved values risk incompatibility with future processors.

1.3.3 Instruction Operands

When instructions are represented symbolically, a subset of the IA-32 assembly language is used. In this subset, an instruction has the following format:

label: mnemonic argument1, argument2, argument3

where:

- A **label** is an identifier which is followed by a colon.
- A **mnemonic** is a reserved name for a class of instruction opcodes which have the same function.
- The operands *argument1*, *argument2*, and *argument3* are optional. There may be from zero to three operands, depending on the opcode. When present, they take the form of either literals or identifiers for data items. Operand identifiers are either reserved names of registers or are assumed to be assigned to data items declared in another part of the program (which may not be shown in the example).

When two operands are present in an arithmetic or logical instruction, the right operand is the source and the left operand is the destination.

For example:

```
LOADREG: MOV EAX, SUBTOTAL
```

In this example, LOADREG is a label, MOV is the mnemonic identifier of an opcode, EAX is the destination operand, and SUBTOTAL is the source operand. Some assembly languages put the source and destination in reverse order.

1.3.4 Hexadecimal and Binary Numbers

Base 16 (hexadecimal) numbers are represented by a string of hexadecimal digits followed by the character H (for example, F82EH). A hexadecimal digit is a character from the following set: 0, 1, 2, 3, 4, 5, 6, 7, 8, 9, A, B, C, D, E, and F.

Base 2 (binary) numbers are represented by a string of 1s and 0s, sometimes followed by the character B (for example, 1010B). The “B” designation is only used in situations where confusion as to the type of number might arise.

1.3.5 Segmented Addressing

The processor uses byte addressing. This means memory is organized and accessed as a sequence of bytes. Whether one or more bytes are being accessed, a byte address is used to locate the byte or bytes in memory. The range of memory that can be addressed is called an **address space**.

The processor also supports segmented addressing. This is a form of addressing where a program may have many independent address spaces, called **segments**. For example, a program can keep its code (instructions) and stack in separate segments. Code addresses would always refer to the code space, and stack addresses would always refer to the stack space. The following notation is used to specify a byte address within a segment:

```
Segment-register:Byte-address
```

For example, the following segment address identifies the byte at address FF79H in the segment pointed to by the DS register:

```
DS:FF79H
```

The following segment address identifies an instruction address in the code segment. The CS register points to the code segment and the EIP register contains the address of the instruction.

```
CS:EIP
```

1.3.6 Exceptions

An exception is an event that typically occurs when an instruction causes an error. For example, an attempt to divide by zero generates an exception. However, some exceptions, such as breakpoints, occur under other conditions. Some types of excep-

tions may provide error codes. An error code reports additional information about the error. An example of the notation used to show an exception and error code is shown below:

#PF(fault code)

This example refers to a page-fault exception under conditions where an error code naming a type of fault is reported. Under some conditions, exceptions which produce error codes may not be able to report an accurate code. In this case, the error code is zero, as shown below for a general-protection exception:

#GP(0)

1.3.7 A New Syntax for CPUID, CR, and MSR Values

Obtain feature flags, status, and system information by using the CPUID instruction, by checking control register bits, and by reading model-specific registers. We are moving toward a new syntax to represent this information. See Figure 1-2.

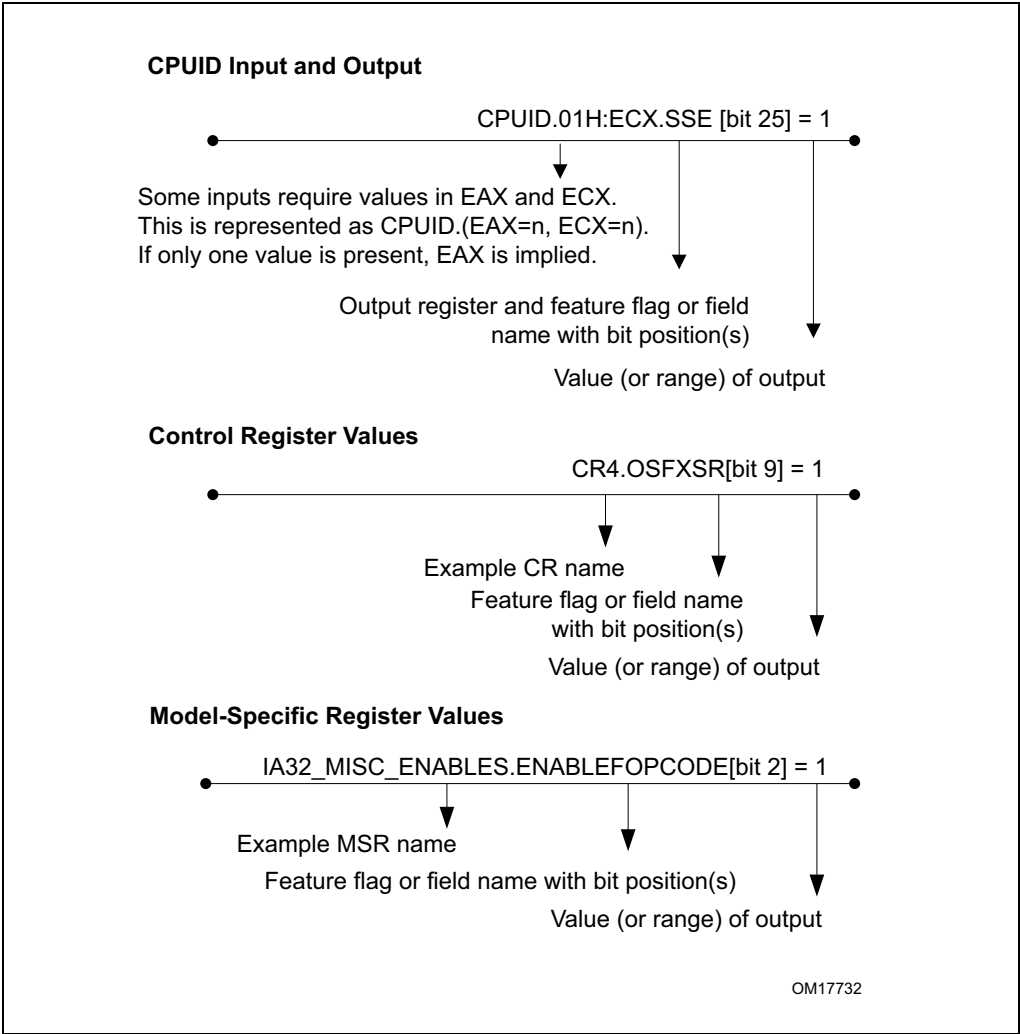

Figure 1-2. Syntax for CPUID, CR, and MSR Data Presentation

1.4 RELATED LITERATURE

Literature related to Intel 64 and IA-32 processors is listed on-line at:

<http://developer.intel.com/products/processor/manuals/index.htm>

Some of the documents listed at this web site can be viewed on-line; others can be ordered. The literature available is listed by Intel processor and then by the following

literature types: applications notes, data sheets, manuals, papers, and specification updates.

See also:

- The data sheet for a particular Intel 64 or IA-32 processor
- The specification update for a particular Intel 64 or IA-32 processor
- Intel® C++ Compiler documentation and online help
<http://www.intel.com/cd/software/products/asm-na/eng/index.htm>
- Intel® Fortran Compiler documentation and online help
<http://www.intel.com/cd/software/products/asm-na/eng/index.htm>
- Intel® VTune™ Performance Analyzer documentation and online help
<http://www.intel.com/cd/software/products/asm-na/eng/index.htm>
- Intel® 64 and IA-32 Architectures Software Developer's Manual (in five volumes)
<http://developer.intel.com/products/processor/manuals/index.htm>
- Intel® 64 and IA-32 Architectures Optimization Reference Manual
<http://developer.intel.com/products/processor/manuals/index.htm>
- Intel® Processor Identification with the CPUID Instruction, AP-485
<http://www.intel.com/support/processors/sb/cs-009861.htm>
- TLBs, Paging-Structure Caches, and Their Invalidation,
<http://developer.intel.com/products/processor/manuals/index.htm>
- Intel 64 Architecture x2APIC Specification:
<http://developer.intel.com/products/processor/manuals/index.htm>
- Intel 64 Architecture Processor Topology Enumeration:
<http://softwarecommunity.intel.com/articles/eng/3887.htm>
- Intel® Trusted Execution Technology Measured Launched Environment Programming Guide, <http://www.intel.com/technology/security/index.htm>
- Intel® SSE4 Programming Reference,
<http://developer.intel.com/products/processor/manuals/index.htm>
- Developing Multi-threaded Applications: A Platform Consistent Approach
http://cache-www.intel.com/cd/00/00/05/15/51534_developing_multithreaded_applications.pdf
- Using Spin-Loops on Intel Pentium 4 Processor and Intel Xeon Processor MP
<http://www3.intel.com/cd/ids/developer/asm-na/eng/dc/threading/knowledgebase/19083.htm>

More relevant links are:

- Software network link:
<http://softwarecommunity.intel.com/isn/home/>
- Developer centers:
<http://www.intel.com/cd/ids/developer/asm-na/eng/dc/index.htm>

ABOUT THIS MANUAL

- Processor support general link:
<http://www.intel.com/support/processors/>
- Software products and packages:
<http://www.intel.com/cd/software/products/asmo-na/eng/index.htm>
- Intel 64 and IA-32 processor manuals (printed or PDF downloads):
<http://developer.intel.com/products/processor/manuals/index.htm>
- Intel® Multi-Core Technology:
<http://developer.intel.com/multi-core/index.htm>
- Intel® Hyper-Threading Technology (Intel® HT Technology):
<http://developer.intel.com/technology/hyperthread/>

CHAPTER 2 INSTRUCTION FORMAT

This chapter describes the instruction format for all Intel 64 and IA-32 processors. The instruction format for protected mode, real-address mode and virtual-8086 mode is described in Section 2.1. Increments provided for IA-32e mode and its sub-modes are described in Section 2.2.

2.1 INSTRUCTION FORMAT FOR PROTECTED MODE, REAL-ADDRESS MODE, AND VIRTUAL-8086 MODE

The Intel 64 and IA-32 architectures instruction encodings are subsets of the format shown in Figure 2-1. Instructions consist of optional instruction prefixes (in any order), primary opcode bytes (up to three bytes), an addressing-form specifier (if required) consisting of the ModR/M byte and sometimes the SIB (Scale-Index-Base) byte, a displacement (if required), and an immediate data field (if required).

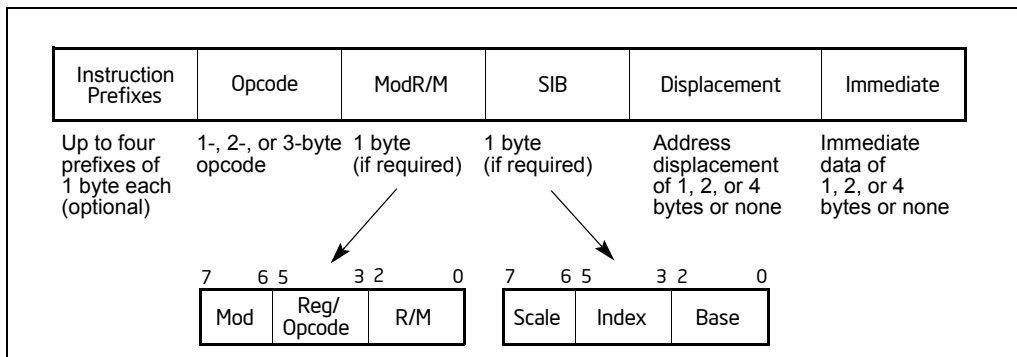

Figure 2-1. Intel 64 and IA-32 Architecture Instruction Format

2.1.1 Instruction Prefixes

Instruction prefixes are divided into four groups, each with a set of allowable prefix codes. For each instruction, it is only useful to include up to one prefix code from each of the four groups (Groups 1, 2, 3, 4). Groups 1 through 4 may be placed in any order relative to each other.

- Group 1
 - Lock and repeat prefixes:

INSTRUCTION FORMAT

- LOCK prefix is encoded using F0H
- REPNE/REPZ prefix is encoded using F2H. Repeat-Not-Zero prefix applies only to string and input/output instructions. (F2H is also used as a mandatory prefix for some instructions)
- REP or REPE/REPZ is encoded using F3H. Repeat prefix applies only to string and input/output instructions. (F3H is also used as a mandatory prefix for some instructions)
- Group 2
 - Segment override prefixes:
 - 2EH—CS segment override (use with any branch instruction is reserved)
 - 36H—SS segment override prefix (use with any branch instruction is reserved)
 - 3EH—DS segment override prefix (use with any branch instruction is reserved)
 - 26H—ES segment override prefix (use with any branch instruction is reserved)
 - 64H—FS segment override prefix (use with any branch instruction is reserved)
 - 65H—GS segment override prefix (use with any branch instruction is reserved)
 - Branch hints:
 - 2EH—Branch not taken (used only with *Jcc* instructions)
 - 3EH—Branch taken (used only with *Jcc* instructions)
- Group 3
 - Operand-size override prefix is encoded using 66H (66H is also used as a mandatory prefix for some instructions).
- Group 4
 - 67H—Address-size override prefix

The LOCK prefix (F0H) forces an operation that ensures exclusive use of shared memory in a multiprocessor environment. See “LOCK—Assert LOCK# Signal Prefix” in Chapter 3, “Instruction Set Reference, A-M,” for a description of this prefix.

Repeat prefixes (F2H, F3H) cause an instruction to be repeated for each element of a string. Use these prefixes only with string and I/O instructions (MOVS, CMPS, SCAS, LODS, STOS, INS, and OUTS). Use of repeat prefixes and/or undefined opcodes with other Intel 64 or IA-32 instructions is reserved; such use may cause unpredictable behavior.

Some instructions may use F2H, F3H as a mandatory prefix to express distinct functionality. A mandatory prefix generally should be placed after other optional prefixes (exception to this is discussed in Section 2.2.1, “REX Prefixes”)

Branch hint prefixes (2EH, 3EH) allow a program to give a hint to the processor about the most likely code path for a branch. Use these prefixes only with conditional branch instructions (*Jcc*). Other use of branch hint prefixes and/or other undefined opcodes with Intel 64 or IA-32 instructions is reserved; such use may cause unpredictable behavior.

The operand-size override prefix allows a program to switch between 16- and 32-bit operand sizes. Either size can be the default; use of the prefix selects the non-default size.

Some SSE2/SSE3/SSSE3/SSE4 instructions and instructions using a three-byte sequence of primary opcode bytes may use 66H as a mandatory prefix to express distinct functionality. A mandatory prefix generally should be placed after other optional prefixes (exception to this is discussed in Section 2.2.1, “REX Prefixes”)

Other use of the 66H prefix is reserved; such use may cause unpredictable behavior.

The address-size override prefix (67H) allows programs to switch between 16- and 32-bit addressing. Either size can be the default; the prefix selects the non-default size. Using this prefix and/or other undefined opcodes when operands for the instruction do not reside in memory is reserved; such use may cause unpredictable behavior.

2.1.2 Opcodes

A primary opcode can be 1, 2, or 3 bytes in length. An additional 3-bit opcode field is sometimes encoded in the ModR/M byte. Smaller fields can be defined within the primary opcode. Such fields define the direction of operation, size of displacements, register encoding, condition codes, or sign extension. Encoding fields used by an opcode vary depending on the class of operation.

Two-byte opcode formats for general-purpose and SIMD instructions consist of:

- An escape opcode byte 0FH as the primary opcode and a second opcode byte, or
- A mandatory prefix (66H, F2H, or F3H), an escape opcode byte, and a second opcode byte (same as previous bullet)

For example, CVTDQ2PD consists of the following sequence: F3 0F E6. The first byte is a mandatory prefix (it is not considered as a repeat prefix).

Three-byte opcode formats for general-purpose and SIMD instructions consist of:

- An escape opcode byte 0FH as the primary opcode, plus two additional opcode bytes, or
- A mandatory prefix (66H, F2H, or F3H), an escape opcode byte, plus two additional opcode bytes (same as previous bullet)

For example, PHADDW for XMM registers consists of the following sequence: 66 0F 38 01. The first byte is the mandatory prefix.

Valid opcode expressions are defined in Appendix A and Appendix B.

2.1.3 ModR/M and SIB Bytes

Many instructions that refer to an operand in memory have an addressing-form specifier byte (called the ModR/M byte) following the primary opcode. The ModR/M byte contains three fields of information:

- The *mod* field combines with the *r/m* field to form 32 possible values: eight registers and 24 addressing modes.
- The *reg/opcode* field specifies either a register number or three more bits of opcode information. The purpose of the *reg/opcode* field is specified in the primary opcode.
- The *r/m* field can specify a register as an operand or it can be combined with the *mod* field to encode an addressing mode. Sometimes, certain combinations of the *mod* field and the *r/m* field is used to express opcode information for some instructions.

Certain encodings of the ModR/M byte require a second addressing byte (the SIB byte). The base-plus-index and scale-plus-index forms of 32-bit addressing require the SIB byte. The SIB byte includes the following fields:

- The *scale* field specifies the scale factor.
- The *index* field specifies the register number of the index register.
- The *base* field specifies the register number of the base register.

See Section 2.1.5 for the encodings of the ModR/M and SIB bytes.

2.1.4 Displacement and Immediate Bytes

Some addressing forms include a displacement immediately following the ModR/M byte (or the SIB byte if one is present). If a displacement is required; it be 1, 2, or 4 bytes.

If an instruction specifies an immediate operand, the operand always follows any displacement bytes. An immediate operand can be 1, 2 or 4 bytes.

2.1.5 Addressing-Mode Encoding of ModR/M and SIB Bytes

The values and corresponding addressing forms of the ModR/M and SIB bytes are shown in Table 2-1 through Table 2-3: 16-bit addressing forms specified by the ModR/M byte are in Table 2-1 and 32-bit addressing forms are in Table 2-2. Table 2-3 shows 32-bit addressing forms specified by the SIB byte. In cases where the *reg/opcode* field in the ModR/M byte represents an extended opcode, valid encodings are shown in Appendix B.

In Table 2-1 and Table 2-2, the Effective Address column lists 32 effective addresses that can be assigned to the first operand of an instruction by using the Mod and R/M fields of the ModR/M byte. The first 24 options provide ways of specifying a memory

location; the last eight (Mod = 11B) provide ways of specifying general-purpose, MMX technology and XMM registers.

The Mod and R/M columns in Table 2-1 and Table 2-2 give the binary encodings of the Mod and R/M fields required to obtain the effective address listed in the first column. For example: see the row indicated by Mod = 11B, R/M = 000B. The row identifies the general-purpose registers EAX, AX or AL; MMX technology register MM0; or XMM register XMM0. The register used is determined by the opcode byte and the operand-size attribute.

Now look at the seventh row in either table (labeled "REG ="). This row specifies the use of the 3-bit Reg/Opcode field when the field is used to give the location of a second operand. The second operand must be a general-purpose, MMX technology, or XMM register. Rows one through five list the registers that may correspond to the value in the table. Again, the register used is determined by the opcode byte along with the operand-size attribute.

If the instruction does not require a second operand, then the Reg/Opcode field may be used as an opcode extension. This use is represented by the sixth row in the tables (labeled "/digit (Opcode)"). Note that values in row six are represented in decimal form.

The body of Table 2-1 and Table 2-2 (under the label "Value of ModR/M Byte (in Hexadecimal)") contains a 32 by 8 array that presents all of 256 values of the ModR/M byte (in hexadecimal). Bits 3, 4 and 5 are specified by the column of the table in which a byte resides. The row specifies bits 0, 1 and 2; and bits 6 and 7. The figure below demonstrates interpretation of one table value.

	Mod	11					
	RM					000	
/digit (Opcode);	REG =					001	
	C8H					11001000	

Figure 2-2. Table Interpretation of ModR/M Byte (C8H)

Table 2-1. 16-Bit Addressing Forms with the ModR/M Byte

r8(/r) r16(/r) r32(/r) mm(/r) xmm(/r) (In decimal) /digit (Opcode) (In binary) REG =			AL AX EAX	CL CX ECX	DL DX EDX	BL BX EBX	AH SP ESP	CH BP1 EBP	DH SI ESI	BH DI EDI
			MM0 XMM0	MM1 XMM1	MM2 XMM2	MM3 XMM3	MM4 XMM4	MM5 XMM5	MM6 XMM6	MM7 XMM7
			0 000	1 001	2 010	3 011	4 100	5 101	6 110	7 111
Effective Address	Mod	R/M	Value of ModR/M Byte (in Hexadecimal)							
[BX+SI]	00	000	00	08	10	18	20	28	30	38
[BX+DI]		001	01	09	11	19	21	29	31	39
[BP+SI]		010	02	0A	12	1A	22	2A	32	3A
[BP+DI]		011	03	0B	13	1B	23	2B	33	3B
[SI]		100	04	0C	14	1C	24	2C	34	3C
[DI]		101	05	0D	15	1D	25	2D	35	3D
disp16 ²		110	06	0E	16	1E	26	2E	36	3E
[BX]		111	07	0F	17	1F	27	2F	37	3F
[BX+SI]+disp8 ³	01	000	40	48	50	58	60	68	70	78
[BX+DI]+disp8		001	41	49	51	59	61	69	71	79
[BP+SI]+disp8		010	42	4A	52	5A	62	6A	72	7A
[BP+DI]+disp8		011	43	4B	53	5B	63	6B	73	7B
[SI]+disp8		100	44	4C	54	5C	64	6C	74	7C
[DI]+disp8		101	45	4D	55	5D	65	6D	75	7D
[BP]+disp8		110	46	4E	56	5E	66	6E	76	7E
[BX]+disp8		111	47	4F	57	5F	67	6F	77	7F
[BX+SI]+disp16	10	000	80	88	90	98	A0	A8	B0	B8
[BX+DI]+disp16		001	81	89	91	99	A1	A9	B1	B9
[BP+SI]+disp16		010	82	8A	92	9A	A2	AA	B2	BA
[BP+DI]+disp16		011	83	8B	93	9B	A3	AB	B3	BB
[SI]+disp16		100	84	8C	94	9C	A4	AC	B4	BC
[DI]+disp16		101	85	8D	95	9D	A5	AD	B5	BD
[BP]+disp16		110	86	8E	96	9E	A6	AE	B6	BE
[BX]+disp16		111	87	8F	97	9F	A7	AF	B7	BF
EAX/AX/AL/MM0/XMM0	11	000	C0	C8	D0	D8	E0	E8	F0	F8
ECX/CX/CL/MM1/XMM1		001	C1	C9	D1	D9	E1	E9	F1	F9
EDX/DX/DL/MM2/XMM2		010	C2	CA	D2	DA	E2	EA	F2	FA
EBX/BX/BL/MM3/XMM3		011	C3	CB	D3	DB	E3	EB	F3	FB
ESP/SP/AHMM4/XMM4		100	C4	CC	D4	DC	E4	EC	F4	FC
EBP/BP/CH/MM5/XMM5		101	C5	CD	D5	DD	E5	ED	F5	FD
ESI/SI/DH/MM6/XMM6		110	C6	CE	D6	DE	E6	EE	F6	FE
EDI/DI/BH/MM7/XMM7		111	C7	CF	D7	DF	E7	EF	F7	FF

NOTES:

1. The default segment register is SS for the effective addresses containing a BP index, DS for other effective addresses.
2. The disp16 nomenclature denotes a 16-bit displacement that follows the ModR/M byte and that is added to the index.
3. The disp8 nomenclature denotes an 8-bit displacement that follows the ModR/M byte and that is sign-extended and added to the index.

Table 2-2. 32-Bit Addressing Forms with the ModR/M Byte

r8(/r) r16(/r) r32(/r) mm(/r) xmm(/r) (In decimal) /digit (Opcode) (In binary) REG =			AL AX EAX	CL CX ECX	DL DX EDX	BL BX EBX	AH SP ESP	CH BP EBP	DH SI ESI	BH DI EDI
			MM0 XMM0 0 000	MM1 XMM1 1 001	MM2 XMM2 2 010	MM3 XMM3 3 011	MM4 XMM4 4 100	MM5 XMM5 5 101	MM6 XMM6 6 110	MM7 XMM7 7 111
Effective Address	Mod	R/M	Value of ModR/M Byte (in Hexadecimal)							
[EAX]	00	000	00	08	10	18	20	28	30	38
[ECX]		001	01	09	11	19	21	29	31	39
[EDX]		010	02	0A	12	1A	22	2A	32	3A
[EBX]		011	03	0B	13	1B	23	2B	33	3B
[--][--] ¹		100	04	0C	14	1C	24	2C	34	3C
disp32 ²		101	05	0D	15	1D	25	2D	35	3D
[ESI]		110	06	0E	16	1E	26	2E	36	3E
[EDI]		111	07	0F	17	1F	27	2F	37	3F
[EAX]+disp8 ³	01	000	40	48	50	58	60	68	70	78
[ECX]+disp8		001	41	49	51	59	61	69	71	79
[EDX]+disp8		010	42	4A	52	5A	62	6A	72	7A
[EBX]+disp8		011	43	4B	53	5B	63	6B	73	7B
[--][--]+disp8		100	44	4C	54	5C	64	6C	74	7C
[EBP]+disp8		101	45	4D	55	5D	65	6D	75	7D
[ESI]+disp8		110	46	4E	56	5E	66	6E	76	7E
[EDI]+disp8		111	47	4F	57	5F	67	6F	77	7F
[EAX]+disp32	10	000	80	88	90	98	A0	A8	B0	B8
[ECX]+disp32		001	81	89	91	99	A1	A9	B1	B9
[EDX]+disp32		010	82	8A	92	9A	A2	AA	B2	BA
[EBX]+disp32		011	83	8B	93	9B	A3	AB	B3	BB
[--][--]+disp32		100	84	8C	94	9C	A4	AC	B4	BC
[EBP]+disp32		101	85	8D	95	9D	A5	AD	B5	BD
[ESI]+disp32		110	86	8E	96	9E	A6	AE	B6	BE
[EDI]+disp32		111	87	8F	97	9F	A7	AF	B7	BF
EAX/AX/AL/MM0/XMM0	11	000	C0	C8	D0	D8	E0	E8	F0	F8
ECX/CX/CL/MM/XMM1		001	C1	C9	D1	D9	E1	E9	F1	F9
EDX/DX/DL/MM2/XMM2		010	C2	CA	D2	DA	E2	EA	F2	FA
EBX/BX/BL/MM3/XMM3		011	C3	CB	D3	DB	E3	EB	F3	FB
ESP/SP/AH/MM4/XMM4		100	C4	CC	D4	DC	E4	EC	F4	FC
EBP/BP/CH/MM5/XMM5		101	C5	CD	D5	DD	E5	ED	F5	FD
ESI/SI/DH/MM6/XMM6		110	C6	CE	D6	DE	E6	EE	F6	FE
EDI/DI/BH/MM7/XMM7		111	C7	CF	D7	DF	E7	EF	F7	FF

NOTES:

1. The [--][--] nomenclature means a SIB follows the ModR/M byte.
2. The disp32 nomenclature denotes a 32-bit displacement that follows the ModR/M byte (or the SIB byte if one is present) and that is added to the index.
3. The disp8 nomenclature denotes an 8-bit displacement that follows the ModR/M byte (or the SIB byte if one is present) and that is sign-extended and added to the index.

Table 2-3 is organized to give 256 possible values of the SIB byte (in hexadecimal). General purpose registers used as a base are indicated across the top of the table, along with corresponding values for the SIB byte's base field. Table rows in the body

INSTRUCTION FORMAT

of the table indicate the register used as the index (SIB byte bits 3, 4 and 5) and the scaling factor (determined by SIB byte bits 6 and 7).

Table 2-3. 32-Bit Addressing Forms with the SIB Byte

r32 (In decimal) Base = (In binary) Base =			EAX 0 000	ECX 1 001	EDX 2 010	EBX 3 011	ESP 4 100	[*] 5 101	ESI 6 110	EDI 7 111
Scaled Index	SS	Index	Value of SIB Byte (in Hexadecimal)							
[EAX] [ECX] [EDX] [EBX] none [EBP] [ESI] [EDI]	00	000 001 010 011 100 101 110 111	00 08 10 18 20 28 30 38	01 09 11 19 21 29 31 39	02 0A 12 1A 22 2A 32 3A	03 0B 13 1B 23 2B 33 3B	04 0C 14 1C 24 2C 34 3C	05 0D 15 1D 25 2D 35 3D	06 0E 16 1E 26 2E 36 3E	07 0F 17 1F 27 2F 37 3F
[EAX*2] [ECX*2] [EDX*2] [EBX*2] none [EBP*2] [ESI*2] [EDI*2]	01	000 001 010 011 100 101 110 111	40 48 50 58 60 68 70 78	41 49 51 59 61 69 71 79	42 4A 52 5A 62 6A 72 7A	43 4B 53 5B 63 6B 73 7B	44 4C 54 5C 64 6C 74 7C	45 4D 55 5D 65 6D 75 7D	46 4E 56 5E 66 6E 76 7E	47 4F 57 5F 67 6F 77 7F
[EAX*4] [ECX*4] [EDX*4] [EBX*4] none [EBP*4] [ESI*4] [EDI*4]	10	000 001 010 011 100 101 110 111	80 88 90 98 A0 A8 B0 B8	81 89 91 89 A1 A9 B1 B9	82 8A 92 9A A2 AA B2 BA	83 8B 93 9B A3 AB B3 BB	84 8C 94 9C A4 AC B4 BC	85 8D 95 9D A5 AD B5 BD	86 8E 96 9E A6 AE B6 BE	87 8F 97 9F A7 AF B7 BF
[EAX*8] [ECX*8] [EDX*8] [EBX*8] none [EBP*8] [ESI*8] [EDI*8]	11	000 001 010 011 100 101 110 111	C0 C8 D0 D8 E0 E8 F0 F8	C1 C9 D1 D9 E1 E9 F1 F9	C2 CA D2 DA E2 EA F2 FA	C3 CB D3 DB E3 EB F3 FB	C4 CC D4 DC E4 EC F4 FC	C5 CD D5 DD E5 ED F5 FD	C6 CE D6 DE E6 EE F6 FE	C7 CF D7 DF E7 EF F7 FF

NOTES:

- The [*] nomenclature means a disp32 with no base if the MOD is 00B. Otherwise, [*] means disp8 or disp32 + [EBP]. This provides the following address modes:

MOD bits Effective Address

00 [scaled index] + disp32

01 [scaled index] + disp8 + [EBP]

10 [scaled index] + disp32 + [EBP]

2.2 IA-32E MODE

IA-32e mode has two sub-modes. These are:

- **Compatibility Mode.** Enables a 64-bit operating system to run most legacy protected mode software unmodified.
- **64-Bit Mode.** Enables a 64-bit operating system to run applications written to access 64-bit address space.

2.2.1 REX Prefixes

REX prefixes are instruction-prefix bytes used in 64-bit mode. They do the following:

- Specify GPRs and SSE registers.
- Specify 64-bit operand size.
- Specify extended control registers.

Not all instructions require a REX prefix in 64-bit mode. A prefix is necessary only if an instruction references one of the extended registers or uses a 64-bit operand. If a REX prefix is used when it has no meaning, it is ignored.

Only one REX prefix is allowed per instruction. If used, the REX prefix byte must immediately precede the opcode byte or the escape opcode byte (OFH). When a REX prefix is used in conjunction with an instruction containing a mandatory prefix, the mandatory prefix must come before the REX so the REX prefix can be immediately preceding the opcode or the escape byte. For example, CVTDQ2PD with a REX prefix should have REX placed between F3 and OF E6. Other placements are ignored. The instruction-size limit of 15 bytes still applies to instructions with a REX prefix. See Figure 2-3.

Legacy Prefixes	REX Prefix	Opcode	ModR/M	SIB	Displacement	Immediate
Grp 1, Grp 2, Grp 3, Grp 4 (optional)	(optional)	1-, 2-, or 3-byte opcode	1 byte (if required)	1 byte (if required)	Address displacement of 1, 2, or 4 bytes	Immediate data of 1, 2, or 4 bytes or none

Figure 2-3. Prefix Ordering in 64-bit Mode

2.2.1.1 Encoding

Intel 64 and IA-32 instruction formats specify up to three registers by using 3-bit fields in the encoding, depending on the format:

- ModR/M: the reg and r/m fields of the ModR/M byte
- ModR/M with SIB: the reg field of the ModR/M byte, the base and index fields of the SIB (scale, index, base) byte
- Instructions without ModR/M: the reg field of the opcode

In 64-bit mode, these formats do not change. Bits needed to define fields in the 64-bit context are provided by the addition of REX prefixes.

2.2.1.2 More on REX Prefix Fields

REX prefixes are a set of 16 opcodes that span one row of the opcode map and occupy entries 40H to 4FH. These opcodes represent valid instructions (INC or DEC) in IA-32 operating modes and in compatibility mode. In 64-bit mode, the same opcodes represent the instruction prefix REX and are not treated as individual instructions.

The single-byte-opcode form of INC/DEC instruction not available in 64-bit mode. INC/DEC functionality is still available using ModR/M forms of the same instructions (opcodes FF/0 and FF/1).

See Table 2-4 for a summary of the REX prefix format. Figure 2-4 though Figure 2-7 show examples of REX prefix fields in use. Some combinations of REX prefix fields are invalid. In such cases, the prefix is ignored. Some additional information follows:

- Setting REX.W can be used to determine the operand size but does not solely determine operand width. Like the 66H size prefix, 64-bit operand size override has no effect on byte-specific operations.
- For non-byte operations: if a 66H prefix is used with prefix (REX.W = 1), 66H is ignored.
- If a 66H override is used with REX and REX.W = 0, the operand size is 16 bits.
- REX.R modifies the ModR/M reg field when that field encodes a GPR, SSE, control or debug register. REX.R is ignored when ModR/M specifies other registers or defines an extended opcode.
- REX.X bit modifies the SIB index field.
- REX.B either modifies the base in the ModR/M r/m field or SIB base field; or it modifies the opcode reg field used for accessing GPRs.

Table 2-4. REX Prefix Fields [BITS: 0100WRXB]

Field Name	Bit Position	Definition
-	7:4	0100
W	3	0 = Operand size determined by CS.D 1 = 64 Bit Operand Size
R	2	Extension of the ModR/M reg field
X	1	Extension of the SIB index field
B	0	Extension of the ModR/M r/m field, SIB base field, or Opcode reg field

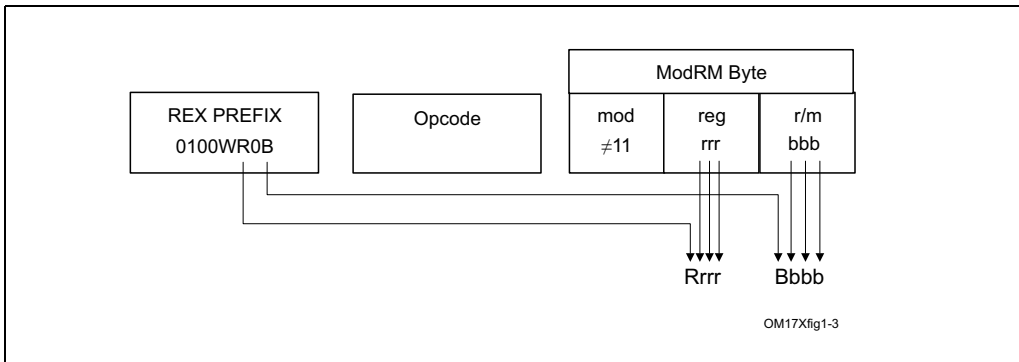
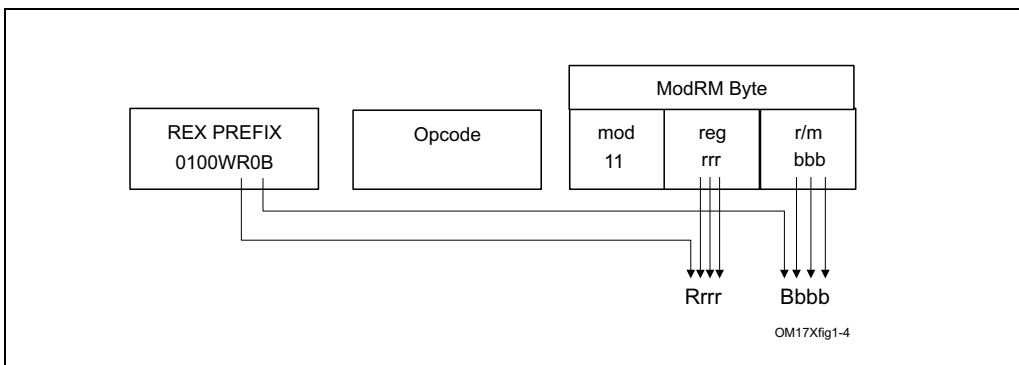
**Figure 2-4. Memory Addressing Without an SIB Byte; REX.X Not Used****Figure 2-5. Register-Register Addressing (No Memory Operand); REX.X Not Used**

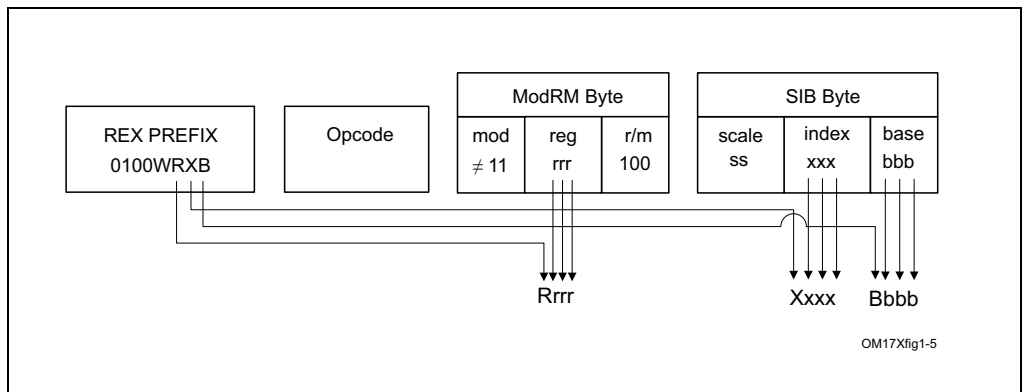

Figure 2-6. Memory Addressing With a SIB Byte

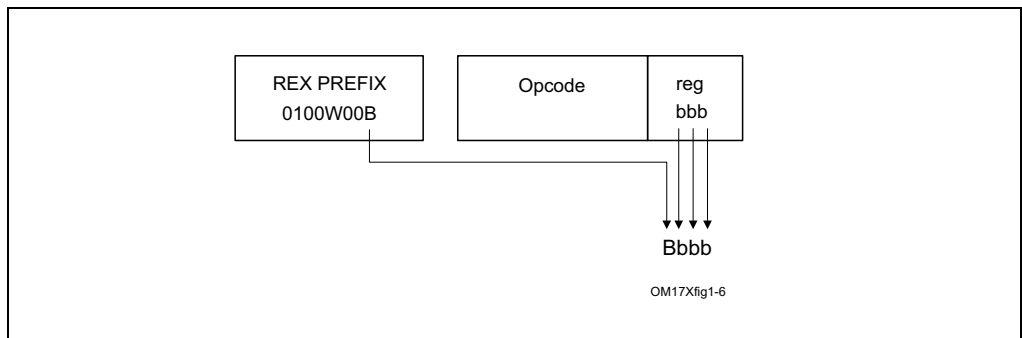

Figure 2-7. Register Operand Coded in Opcode Byte; REX.X & REX.R Not Used

In the IA-32 architecture, byte registers (AH, AL, BH, BL, CH, CL, DH, and DL) are encoded in the ModR/M byte’s reg field, the r/m field or the opcode reg field as registers 0 through 7. REX prefixes provide an additional addressing capability for byte-registers that makes the least-significant byte of GPRs available for byte operations. Certain combinations of the fields of the ModR/M byte and the SIB byte have special meaning for register encodings. For some combinations, fields expanded by the REX prefix are not decoded. Table 2-5 describes how each case behaves.

Table 2-5. Special Cases of REX Encodings

ModR/M or SIB	Sub-field Encodings	Compatibility Mode Operation	Compatibility Mode Implications	Additional Implications
ModR/M Byte	mod != 11	SIB byte present.	SIB byte required for ESP-based addressing.	REX prefix adds a fourth bit (b) which is not decoded (don't care). SIB byte also required for R12-based addressing.
	r/m == b*100(ESP)			
ModR/M Byte	mod == 0	Base register not used.	EBP without a displacement must be done using mod = 01 with displacement of 0.	REX prefix adds a fourth bit (b) which is not decoded (don't care). Using RBP or R13 without displacement must be done using mod = 01 with a displacement of 0.
	r/m == b*101(EBP)			
SIB Byte	index == 0100(ESP)	Index register not used.	ESP cannot be used as an index register.	REX prefix adds a fourth bit (b) which is decoded. There are no additional implications. The expanded index field allows distinguishing RSP from R12, therefore R12 can be used as an index.
SIB Byte	base == 0101(EBP)	Base register is unused if mod = 0.	Base register depends on mod encoding.	REX prefix adds a fourth bit (b) which is not decoded. This requires explicit displacement to be used with EBP/RBP or R13.

NOTES:

* Don't care about value of REX.B

2.2.1.3 Displacement

Addressing in 64-bit mode uses existing 32-bit ModR/M and SIB encodings. The ModR/M and SIB displacement sizes do not change. They remain 8 bits or 32 bits and are sign-extended to 64 bits.

2.2.1.4 Direct Memory-Offset MOVs

In 64-bit mode, direct memory-offset forms of the MOV instruction are extended to specify a 64-bit immediate absolute address. This address is called a moffset. No prefix is needed to specify this 64-bit memory offset. For these MOV instructions, the

size of the memory offset follows the address-size default (64 bits in 64-bit mode). See Table 2-6.

Table 2-6. Direct Memory Offset Form of MOV

Opcode	Instruction
A0	MOV AL, moffset
A1	MOV EAX, moffset
A2	MOV moffset, AL
A3	MOV moffset, EAX

2.2.1.5 Immediates

In 64-bit mode, the typical size of immediate operands remains 32 bits. When the operand size is 64 bits, the processor sign-extends all immediates to 64 bits prior to their use.

Support for 64-bit immediate operands is accomplished by expanding the semantics of the existing move (MOV reg, imm16/32) instructions. These instructions (opcodes B8H – BFH) move 16-bits or 32-bits of immediate data (depending on the effective operand size) into a GPR. When the effective operand size is 64 bits, these instructions can be used to load an immediate into a GPR. A REX prefix is needed to override the 32-bit default operand size to a 64-bit operand size.

For example:

```
48 B8 8877665544332211 MOV RAX,1122334455667788H
```

2.2.1.6 RIP-Relative Addressing

A new addressing form, RIP-relative (relative instruction-pointer) addressing, is implemented in 64-bit mode. An effective address is formed by adding displacement to the 64-bit RIP of the next instruction.

In IA-32 architecture and compatibility mode, addressing relative to the instruction pointer is available only with control-transfer instructions. In 64-bit mode, instructions that use ModR/M addressing can use RIP-relative addressing. Without RIP-relative addressing, all ModR/M instruction modes address memory relative to zero.

RIP-relative addressing allows specific ModR/M modes to address memory relative to the 64-bit RIP using a signed 32-bit displacement. This provides an offset range of $\pm 2\text{GB}$ from the RIP. Table 2-7 shows the ModR/M and SIB encodings for RIP-relative addressing. Redundant forms of 32-bit displacement-addressing exist in the current ModR/M and SIB encodings. There is one ModR/M encoding and there are several SIB encodings. RIP-relative addressing is encoded using a redundant form.

In 64-bit mode, the ModR/M Disp32 (32-bit displacement) encoding is re-defined to be RIP+Disp32 rather than displacement-only. See Table 2-7.

Table 2-7. RIP-Relative Addressing

ModR/M and SIB Sub-field Encodings		Compatibility Mode Operation	64-bit Mode Operation	Additional Implications in 64-bit mode
ModR/M Byte	mod == 00	Disp32	RIP + Disp32	Must use SIB form with normal (zero-based) displacement addressing
	r/m == 101 (none)			
SIB Byte	base == 101 (none)	if mod = 00, Disp32	Same as legacy	None
	index == 100 (none)			
	scale = 0, 1, 2, 4			

The ModR/M encoding for RIP-relative addressing does not depend on using prefix. Specifically, the r/m bit field encoding of 101B (used to select RIP-relative addressing) is not affected by the REX prefix. For example, selecting R13 (REX.B = 1, r/m = 101B) with mod = 00B still results in RIP-relative addressing. The 4-bit r/m field of REX.B combined with ModR/M is not fully decoded. In order to address R13 with no displacement, software must encode R13 + 0 using a 1-byte displacement of zero.

RIP-relative addressing is enabled by 64-bit mode, not by a 64-bit address-size. The use of the address-size prefix does not disable RIP-relative addressing. The effect of the address-size prefix is to truncate and zero-extend the computed effective address to 32 bits.

2.2.1.7 Default 64-Bit Operand Size

In 64-bit mode, two groups of instructions have a default operand size of 64 bits (do not need a REX prefix for this operand size). These are:

- Near branches
- All instructions, except far branches, that implicitly reference the RSP

2.2.2 Additional Encodings for Control and Debug Registers

In 64-bit mode, more encodings for control and debug registers are available. The REX.R bit is used to modify the ModR/M reg field when that field encodes a control or debug register (see Table 2-4). These encodings enable the processor to address CR8-CR15 and DR8-DR15. An additional control register (CR8) is defined in 64-bit mode. CR8 becomes the Task Priority Register (TPR).

In the first implementation of IA-32e mode, CR9-CR15 and DR8-DR15 are not implemented. Any attempt to access unimplemented registers results in an invalid-opcode exception (#UD).

INSTRUCTION FORMAT

CHAPTER 3

INSTRUCTION SET REFERENCE, A-M

This chapter describes the instruction set for the Intel 64 and IA-32 architectures (A-M) in IA-32e, protected, Virtual-8086, and real modes of operation. The set includes general-purpose, x87 FPU, MMX, SSE/SSE2/SSE3/SSSE3/SSE4, and system instructions. See also Chapter 4, "Instruction Set Reference, N-Z," in the *Intel® 64 and IA-32 Architectures Software Developer's Manual, Volume 2B*.

For each instruction, each operand combination is described. A description of the instruction and its operand, an operational description, a description of the effect of the instructions on flags in the EFLAGS register, and a summary of exceptions that can be generated are also provided.

3.1 INTERPRETING THE INSTRUCTION REFERENCE PAGES

This section describes the format of information contained in the instruction reference pages in this chapter. It explains notational conventions and abbreviations used in these sections.

3.1.1 Instruction Format

The following is an example of the format used for each instruction description in this chapter. The heading below introduces the example. The table below provides an example summary table.

CMC—Complement Carry Flag [this is an example]

Opcode	Instruction	64-bit Mode	Compat/ Leg Mode	Description
F5	CMC	Valid	Valid	Complement carry flag.

3.1.1.1 Opcode Column in the Instruction Summary Table

The “Opcode” column in the table above shows the object code produced for each form of the instruction. When possible, codes are given as hexadecimal bytes in the same order in which they appear in memory. Definitions of entries other than hexadecimal bytes are as follows:

- **REX.W** — Indicates the use of a REX prefix that affects operand size or instruction semantics. The ordering of the REX prefix and other optional/mandatory instruction prefixes are discussed Chapter 2. Note that REX prefixes that promote legacy instructions to 64-bit behavior are not listed explicitly in the opcode column.
- **/digit** — A digit between 0 and 7 indicates that the ModR/M byte of the instruction uses only the r/m (register or memory) operand. The reg field contains the digit that provides an extension to the instruction's opcode.
- **/r** — Indicates that the ModR/M byte of the instruction contains a register operand and an r/m operand.
- **cb, cw, cd, cp, co, ct** — A 1-byte (cb), 2-byte (cw), 4-byte (cd), 6-byte (cp), 8-byte (co) or 10-byte (ct) value following the opcode. This value is used to specify a code offset and possibly a new value for the code segment register.
- **ib, iw, id, io** — A 1-byte (ib), 2-byte (iw), 4-byte (id) or 8-byte (io) immediate operand to the instruction that follows the opcode, ModR/M bytes or scale-indexing bytes. The opcode determines if the operand is a signed value. All words, doublewords and quadwords are given with the low-order byte first.
- **+rb, +rw, +rd, +ro** — A register code, from 0 through 7, added to the hexadecimal byte given at the left of the plus sign to form a single opcode byte. See Table 3-1 for the codes. The +ro columns in the table are applicable only in 64-bit mode.
- **+i** — A number used in floating-point instructions when one of the operands is ST(i) from the FPU register stack. The number i (which can range from 0 to 7) is added to the hexadecimal byte given at the left of the plus sign to form a single opcode byte.

Table 3-1. Register Codes Associated With +rb, +rw, +rd, +ro

byte register			word register			dword register			quadword register (64-Bit Mode only)		
Register	REX.B	Reg Field	Register	REX.B	Reg Field	Register	REX.B	Reg Field	Register	REX.B	Reg Field
AL	None	0	AX	None	0	EAX	None	0	RAX	None	0
CL	None	1	CX	None	1	ECX	None	1	RCX	None	1
DL	None	2	DX	None	2	EDX	None	2	RDX	None	2

Table 3-1. Register Codes Associated With +rb, +rw, +rd, +ro (Contd.)

byte register			word register			dword register			quadword register (64-Bit Mode only)		
Register	REX.B	Reg Field	Register	REX.B	Reg Field	Register	REX.B	Reg Field	Register	REX.B	Reg Field
BL	None	3	BX	None	3	EBX	None	3	RBX	None	3
AH	Not encodable (N.E.)	4	SP	None	4	ESP	None	4	N/A	N/A	N/A
CH	N.E.	5	BP	None	5	EBP	None	5	N/A	N/A	N/A
DH	N.E.	6	SI	None	6	ESI	None	6	N/A	N/A	N/A
BH	N.E.	7	DI	None	7	EDI	None	7	N/A	N/A	N/A
SPL	Yes	4	SP	None	4	ESP	None	4	RSP	None	4
BPL	Yes	5	BP	None	5	EBP	None	5	RBP	None	5
SIL	Yes	6	SI	None	6	ESI	None	6	RSI	None	6
DIL	Yes	7	DI	None	7	EDI	None	7	RDI	None	7
Registers R8 - R15 (see below): Available in 64-Bit Mode Only											
R8L	Yes	0	R8W	Yes	0	R8D	Yes	0	R8	Yes	0
R9L	Yes	1	R9W	Yes	1	R9D	Yes	1	R9	Yes	1
R10L	Yes	2	R10W	Yes	2	R10D	Yes	2	R10	Yes	2
R11L	Yes	3	R11W	Yes	3	R11D	Yes	3	R11	Yes	3
R12L	Yes	4	R12W	Yes	4	R12D	Yes	4	R12	Yes	4
R13L	Yes	5	R13W	Yes	5	R13D	Yes	5	R13	Yes	5
R14L	Yes	6	R14W	Yes	6	R14D	Yes	6	R14	Yes	6
R15L	Yes	7	R15W	Yes	7	R15D	Yes	7	R15	Yes	7

3.1.1.2 Instruction Column in the Opcode Summary Table

The “Instruction” column gives the syntax of the instruction statement as it would appear in an ASM386 program. The following is a list of the symbols used to represent operands in the instruction statements:

- **rel8** — A relative address in the range from 128 bytes before the end of the instruction to 127 bytes after the end of the instruction.
- **rel16, rel32, rel64** — A relative address within the same code segment as the instruction assembled. The rel16 symbol applies to instructions with an operand-size attribute of 16 bits; the rel32 symbol applies to instructions with an operand-size attribute of 32 bits; the rel64 symbol applies to instructions with an operand-size attribute of 64 bits.

- **ptr16:16, ptr16:32 and ptr16:64** — A far pointer, typically to a code segment different from that of the instruction. The notation *16:16* indicates that the value of the pointer has two parts. The value to the left of the colon is a 16-bit selector or value destined for the code segment register. The value to the right corresponds to the offset within the destination segment. The ptr16:16 symbol is used when the instruction's operand-size attribute is 16 bits; the ptr16:32 symbol is used when the operand-size attribute is 32 bits; the ptr16:64 symbol is used when the operand-size attribute is 64 bits.
- **r8** — One of the byte general-purpose registers: AL, CL, DL, BL, AH, CH, DH, BH, BPL, SPL, DIL and SIL; or one of the byte registers (R8L - R15L) available when using REX.R and 64-bit mode.
- **r16** — One of the word general-purpose registers: AX, CX, DX, BX, SP, BP, SI, DI; or one of the word registers (R8-R15) available when using REX.R and 64-bit mode.
- **r32** — One of the doubleword general-purpose registers: EAX, ECX, EDX, EBX, ESP, EBP, ESI, EDI; or one of the doubleword registers (R8D - R15D) available when using REX.R in 64-bit mode.
- **r64** — One of the quadword general-purpose registers: RAX, RBX, RCX, RDX, RDI, RSI, RBP, RSP, R8-R15. These are available when using REX.R and 64-bit mode.
- **imm8** — An immediate byte value. The imm8 symbol is a signed number between -128 and +127 inclusive. For instructions in which imm8 is combined with a word or doubleword operand, the immediate value is sign-extended to form a word or doubleword. The upper byte of the word is filled with the topmost bit of the immediate value.
- **imm16** — An immediate word value used for instructions whose operand-size attribute is 16 bits. This is a number between -32,768 and +32,767 inclusive.
- **imm32** — An immediate doubleword value used for instructions whose operand-size attribute is 32 bits. It allows the use of a number between +2,147,483,647 and -2,147,483,648 inclusive.
- **imm64** — An immediate quadword value used for instructions whose operand-size attribute is 64 bits. The value allows the use of a number between +9,223,372,036,854,775,807 and -9,223,372,036,854,775,808 inclusive.
- **r/m8** — A byte operand that is either the contents of a byte general-purpose register (AL, CL, DL, BL, AH, CH, DH, BH, BPL, SPL, DIL and SIL) or a byte from memory. Byte registers R8L - R15L are available using REX.R in 64-bit mode.
- **r/m16** — A word general-purpose register or memory operand used for instructions whose operand-size attribute is 16 bits. The word general-purpose registers are: AX, CX, DX, BX, SP, BP, SI, DI. The contents of memory are found at the address provided by the effective address computation. Word registers R8W - R15W are available using REX.R in 64-bit mode.

- **r/m32** — A doubleword general-purpose register or memory operand used for instructions whose operand-size attribute is 32 bits. The doubleword general-purpose registers are: EAX, ECX, EDX, EBX, ESP, EBP, ESI, EDI. The contents of memory are found at the address provided by the effective address computation. Doubleword registers R8D - R15D are available when using REX.R in 64-bit mode.
- **r/m64** — A quadword general-purpose register or memory operand used for instructions whose operand-size attribute is 64 bits when using REX.W. Quadword general-purpose registers are: RAX, RBX, RCX, RDX, RDI, RSI, RBP, RSP, R8–R15; these are available only in 64-bit mode. The contents of memory are found at the address provided by the effective address computation.
- **m** — A 16-, 32- or 64-bit operand in memory.
- **m8** — A byte operand in memory, usually expressed as a variable or array name, but pointed to by the DS: (E)SI or ES: (E)DI registers. In 64-bit mode, it is pointed to by the RSI or RDI registers.
- **m16** — A word operand in memory, usually expressed as a variable or array name, but pointed to by the DS: (E)SI or ES: (E)DI registers. This nomenclature is used only with the string instructions.
- **m32** — A doubleword operand in memory, usually expressed as a variable or array name, but pointed to by the DS: (E)SI or ES: (E)DI registers. This nomenclature is used only with the string instructions.
- **m64** — A memory quadword operand in memory.
- **m128** — A memory double quadword operand in memory.
- **m16:16, m16:32 & m16:64** — A memory operand containing a far pointer composed of two numbers. The number to the left of the colon corresponds to the pointer's segment selector. The number to the right corresponds to its offset.
- **m16&32, m16&16, m32&32, m16&64** — A memory operand consisting of data item pairs whose sizes are indicated on the left and the right side of the ampersand. All memory addressing modes are allowed. The m16&16 and m32&32 operands are used by the BOUND instruction to provide an operand containing an upper and lower bounds for array indices. The m16&32 operand is used by LIDT and LGDT to provide a word with which to load the limit field, and a doubleword with which to load the base field of the corresponding GDTR and IDTR registers. The m16&64 operand is used by LIDT and LGDT in 64-bit mode to provide a word with which to load the limit field, and a quadword with which to load the base field of the corresponding GDTR and IDTR registers.
- **moffs8, moffs16, moffs32, moffs64** — A simple memory variable (memory offset) of type byte, word, or doubleword used by some variants of the MOV instruction. The actual address is given by a simple offset relative to the segment base. No ModR/M byte is used in the instruction. The number shown with moffs indicates its size, which is determined by the address-size attribute of the instruction.

- **Sreg** — A segment register. The segment register bit assignments are ES = 0, CS = 1, SS = 2, DS = 3, FS = 4, and GS = 5.
- **m32fp, m64fp, m80fp** — A single-precision, double-precision, and double extended-precision (respectively) floating-point operand in memory. These symbols designate floating-point values that are used as operands for x87 FPU floating-point instructions.
- **m16int, m32int, m64int** — A word, doubleword, and quadword integer (respectively) operand in memory. These symbols designate integers that are used as operands for x87 FPU integer instructions.
- **ST or ST(0)** — The top element of the FPU register stack.
- **ST(i)** — The i^{th} element from the top of the FPU register stack ($i \leftarrow 0$ through 7).
- **mm** — An MMX register. The 64-bit MMX registers are: MM0 through MM7.
- **mm/m32** — The low order 32 bits of an MMX register or a 32-bit memory operand. The 64-bit MMX registers are: MM0 through MM7. The contents of memory are found at the address provided by the effective address computation.
- **mm/m64** — An MMX register or a 64-bit memory operand. The 64-bit MMX registers are: MM0 through MM7. The contents of memory are found at the address provided by the effective address computation.
- **xmm** — An XMM register. The 128-bit XMM registers are: XMM0 through XMM7; XMM8 through XMM15 are available using REX.R in 64-bit mode.
- **xmm/m32** — An XMM register or a 32-bit memory operand. The 128-bit XMM registers are XMM0 through XMM7; XMM8 through XMM15 are available using REX.R in 64-bit mode. The contents of memory are found at the address provided by the effective address computation.
- **xmm/m64** — An XMM register or a 64-bit memory operand. The 128-bit SIMD floating-point registers are XMM0 through XMM7; XMM8 through XMM15 are available using REX.R in 64-bit mode. The contents of memory are found at the address provided by the effective address computation.
- **xmm/m128** — An XMM register or a 128-bit memory operand. The 128-bit XMM registers are XMM0 through XMM7; XMM8 through XMM15 are available using REX.R in 64-bit mode. The contents of memory are found at the address provided by the effective address computation.
- **<XMM0>**: indicates implied use of the XMM0 register.

When there is ambiguity, `xmm1` indicates the first source operand using an XMM register and `xmm2` the second source operand using an XMM register.

Some instructions use the XMM0 register as the third source operand, indicated by `<XMM0>`. The use of the third XMM register operand is implicit in the instruction encoding and does not affect the ModR/M encoding.

3.1.1.3 64-bit Mode Column in the Instruction Summary Table

The “64-bit Mode” column indicates whether the opcode sequence is supported in 64-bit mode. The column uses the following notation:

- **Valid** — Supported.
- **Invalid** — Not supported.
- **N.E.** — Indicates an instruction syntax is not encodable in 64-bit mode (it may represent part of a sequence of valid instructions in other modes).
- **N.P.** — Indicates the REX prefix does not affect the legacy instruction in 64-bit mode.
- **N.I.** — Indicates the opcode is treated as a new instruction in 64-bit mode.
- **N.S.** — Indicates an instruction syntax that requires an address override prefix in 64-bit mode and is not supported. Using an address override prefix in 64-bit mode may result in model-specific execution behavior.

3.1.1.4 Compatibility/Legacy Mode Column in the Instruction Summary Table

The “Compatibility/Legacy Mode” column provides information on the opcode sequence in either the compatibility mode or other IA-32 modes. The column uses the following notation:

- **Valid** — Supported.
- **Invalid** — Not supported.
- **N.E.** — Indicates an Intel 64 instruction mnemonics/syntax that is not encodable; the opcode sequence is not applicable as an individual instruction in compatibility mode or IA-32 mode. The opcode may represent a valid sequence of legacy IA-32 instructions.

3.1.1.5 Description Column in the Instruction Summary Table

The “Description” column briefly explains forms of the instruction.

3.1.1.6 Description Section

Each instruction is then described by number of information sections. The “Description” section describes the purpose of the instructions and required operands in more detail.

3.1.1.7 Operation Section

The “Operation” section contains an algorithm description (frequently written in pseudo-code) for the instruction. Algorithms are composed of the following elements:

- Comments are enclosed within the symbol pairs “(*)” and “**”).
- Compound statements are enclosed in keywords, such as: IF, THEN, ELSE and FI for an if statement; DO and OD for a do statement; or CASE... OF for a case statement.
- A register name implies the contents of the register. A register name enclosed in brackets implies the contents of the location whose address is contained in that register. For example, ES: [DI] indicates the contents of the location whose ES segment relative address is in register DI. [SI] indicates the contents of the address contained in register SI relative to the SI register’s default segment (DS) or the overridden segment.
- Parentheses around the “E” in a general-purpose register name, such as (E)SI, indicates that the offset is read from the SI register if the address-size attribute is 16, from the ESI register if the address-size attribute is 32. Parentheses around the “R” in a general-purpose register name, (R)SI, in the presence of a 64-bit register definition such as (R)SI, indicates that the offset is read from the 64-bit RSI register if the address-size attribute is 64.
- Brackets are used for memory operands where they mean that the contents of the memory location is a segment-relative offset. For example, [SRC] indicates that the content of the source operand is a segment-relative offset.
- $A \leftarrow B$ indicates that the value of B is assigned to A.
- The symbols =, ≠, >, <, ≥, and ≤ are relational operators used to compare two values: meaning equal, not equal, greater or equal, less or equal, respectively. A relational expression such as $A \leftarrow B$ is TRUE if the value of A is equal to B; otherwise it is FALSE.
- The expression “<< COUNT” and “>> COUNT” indicates that the destination operand should be shifted left or right by the number of bits indicated by the count operand.

The following identifiers are used in the algorithmic descriptions:

- **OperandSize and AddressSize** — The OperandSize identifier represents the operand-size attribute of the instruction, which is 16, 32 or 64-bits. The AddressSize identifier represents the address-size attribute, which is 16, 32 or 64-bits. For example, the following pseudo-code indicates that the operand-size attribute depends on the form of the MOV instruction used.

```

IF Instruction ← MOVW
    THEN OperandSize ← 16;
ELSE
    IF Instruction ← MOVD
        THEN OperandSize ← 32;
    ELSE
        IF Instruction ← MOVQ
            THEN OperandSize ← 64;
        FI;

```

F;
F;

See “Operand-Size and Address-Size Attributes” in Chapter 3 of the *Intel® 64 and IA-32 Architectures Software Developer’s Manual, Volume 1*, for guidelines on how these attributes are determined.

- **StackAddrSize** — Represents the stack address-size attribute associated with the instruction, which has a value of 16, 32 or 64-bits. See “Address-Size Attribute for Stack” in Chapter 6, “Procedure Calls, Interrupts, and Exceptions,” of the *Intel® 64 and IA-32 Architectures Software Developer’s Manual, Volume 1*.
- **SRC** — Represents the source operand.
- **DEST** — Represents the destination operand.

The following functions are used in the algorithmic descriptions:

- **ZeroExtend(value)** — Returns a value zero-extended to the operand-size attribute of the instruction. For example, if the operand-size attribute is 32, zero extending a byte value of -10 converts the byte from F6H to a doubleword value of 000000F6H. If the value passed to the ZeroExtend function and the operand-size attribute are the same size, ZeroExtend returns the value unaltered.
- **SignExtend(value)** — Returns a value sign-extended to the operand-size attribute of the instruction. For example, if the operand-size attribute is 32, sign extending a byte containing the value -10 converts the byte from F6H to a doubleword value of FFFFFFF6H. If the value passed to the SignExtend function and the operand-size attribute are the same size, SignExtend returns the value unaltered.
- **SaturateSignedWordToSignedByte** — Converts a signed 16-bit value to a signed 8-bit value. If the signed 16-bit value is less than -128 , it is represented by the saturated value -128 (80H); if it is greater than 127, it is represented by the saturated value 127 (7FH).
- **SaturateSignedDwordToSignedWord** — Converts a signed 32-bit value to a signed 16-bit value. If the signed 32-bit value is less than -32768 , it is represented by the saturated value -32768 (8000H); if it is greater than 32767, it is represented by the saturated value 32767 (7FFFH).
- **SaturateSignedWordToUnsignedByte** — Converts a signed 16-bit value to an unsigned 8-bit value. If the signed 16-bit value is less than zero, it is represented by the saturated value zero (00H); if it is greater than 255, it is represented by the saturated value 255 (FFH).
- **SaturateToSignedByte** — Represents the result of an operation as a signed 8-bit value. If the result is less than -128 , it is represented by the saturated value -128 (80H); if it is greater than 127, it is represented by the saturated value 127 (7FH).
- **SaturateToSignedWord** — Represents the result of an operation as a signed 16-bit value. If the result is less than -32768 , it is represented by the saturated value -32768 (8000H); if it is greater than 32767, it is represented by the saturated value 32767 (7FFFH).

- **SaturateToUnsignedByte** — Represents the result of an operation as a signed 8-bit value. If the result is less than zero it is represented by the saturated value zero (00H); if it is greater than 255, it is represented by the saturated value 255 (FFH).
- **SaturateToUnsignedWord** — Represents the result of an operation as a signed 16-bit value. If the result is less than zero it is represented by the saturated value zero (00H); if it is greater than 65535, it is represented by the saturated value 65535 (FFFFH).
- **LowOrderWord(DEST * SRC)** — Multiplies a word operand by a word operand and stores the least significant word of the doubleword result in the destination operand.
- **HighOrderWord(DEST * SRC)** — Multiplies a word operand by a word operand and stores the most significant word of the doubleword result in the destination operand.
- **Push(value)** — Pushes a value onto the stack. The number of bytes pushed is determined by the operand-size attribute of the instruction. See the “Operation” subsection of the “PUSH—Push Word, Doubleword or Quadword Onto the Stack” section in Chapter 4 of the *Intel® 64 and IA-32 Architectures Software Developer’s Manual, Volume 2B*.
- **Pop()** removes the value from the top of the stack and returns it. The statement `EAX ← Pop();` assigns to EAX the 32-bit value from the top of the stack. Pop will return either a word, a doubleword or a quadword depending on the operand-size attribute. See the “Operation” subsection in the “POP—Pop a Value from the Stack” section of Chapter 4 of the *Intel® 64 and IA-32 Architectures Software Developer’s Manual, Volume 2B*.
- **PopRegisterStack** — Marks the FPU ST(0) register as empty and increments the FPU register stack pointer (TOP) by 1.
- **Switch-Tasks** — Performs a task switch.
- **Bit(BitBase, BitOffset)** — Returns the value of a bit within a bit string. The bit string is a sequence of bits in memory or a register. Bits are numbered from low-order to high-order within registers and within memory bytes. If the BitBase is a register, the BitOffset can be in the range 0 to [15, 31, 63] depending on the mode and register size. See Figure 3-1: the function `Bit[RAX, 21]` is illustrated.

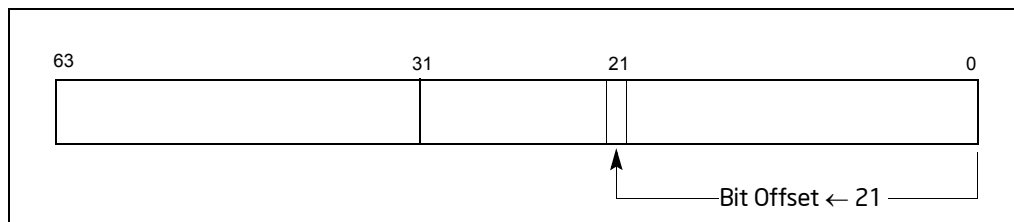

Figure 3-1. Bit Offset for BIT[RAX, 21]

If BitBase is a memory address, the BitOffset can range has different ranges depending on the operand size (see Table 3-2).

Table 3-2. Range of Bit Positions Specified by Bit Offset Operands

Operand Size	Immediate BitOffset	Register BitOffset
16	0 to 15	-2^{15} to $2^{15} - 1$
32	0 to 31	-2^{31} to $2^{31} - 1$
64	0 to 63	-2^{63} to $2^{63} - 1$

The addressed bit is numbered (Offset MOD 8) within the byte at address (BitBase + (BitOffset DIV 8)) where DIV is signed division with rounding towards negative infinity and MOD returns a positive number (see Figure 3-2).

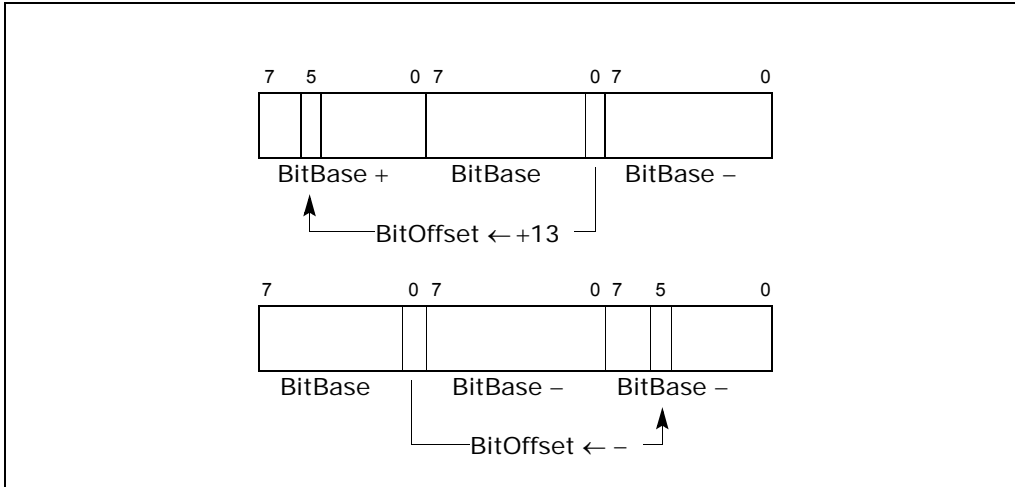

Figure 3-2. Memory Bit Indexing

3.1.1.8 Intel® C/C++ Compiler Intrinsic Equivalents Section

The Intel C/C++ compiler intrinsics equivalents are special C/C++ coding extensions that allow using the syntax of C function calls and C variables instead of hardware registers. Using these intrinsics frees programmers from having to manage registers and assembly programming. Further, the compiler optimizes the instruction scheduling so that executable run faster.

The following sections discuss the intrinsics API and the MMX technology and SIMD floating-point intrinsics. Each intrinsic equivalent is listed with the instruction description. There may be additional intrinsics that do not have an instruction equiv-

alent. It is strongly recommended that the reader reference the compiler documentation for the complete list of supported intrinsics.

See Appendix C, “Intel® C/C++ Compiler Intrinsics and Functional Equivalents,” in the *Intel® 64 and IA-32 Architectures Software Developer’s Manual, Volume 2B*, for more information on using intrinsics.

Intrinsics API

The benefit of coding with MMX technology intrinsics and the SSE/SSE2/SSE3 intrinsics is that you can use the syntax of C function calls and C variables instead of hardware registers. This frees you from managing registers and programming assembly. Further, the compiler optimizes the instruction scheduling so that your executable runs faster. For each computational and data manipulation instruction in the new instruction set, there is a corresponding C intrinsic that implements it directly. The intrinsics allow you to specify the underlying implementation (instruction selection) of an algorithm yet leave instruction scheduling and register allocation to the compiler.

MMX™ Technology Intrinsics

The MMX technology intrinsics are based on a `__m64` data type that represents the specific contents of an MMX technology register. You can specify values in bytes, short integers, 32-bit values, or a 64-bit object. The `__m64` data type, however, is not a basic ANSI C data type, and therefore you must observe the following usage restrictions:

- Use `__m64` data only on the left-hand side of an assignment, as a return value, or as a parameter. You cannot use it with other arithmetic expressions (“+”, “>>”, and so on).
- Use `__m64` objects in aggregates, such as unions to access the byte elements and structures; the address of an `__m64` object may be taken.
- Use `__m64` data only with the MMX technology intrinsics described in this manual and Intel® C/C++ compiler documentation.
- See:
 - <http://www.intel.com/support/performancetools/>
 - Appendix C, “Intel® C/C++ Compiler Intrinsics and Functional Equivalents,” in the *Intel® 64 and IA-32 Architectures Software Developer’s Manual, Volume 2B*, for more information on using intrinsics.
 - SSE/SSE2/SSE3 Intrinsics
 - SSE/SSE2/SSE3 intrinsics all make use of the XMM registers of the Pentium III, Pentium 4, and Intel Xeon processors. There are three data types supported by these intrinsics: `__m128`, `__m128d`, and `__m128i`.

- The `__m128` data type is used to represent the contents of an XMM register used by an SSE intrinsic. This is either four packed single-precision floating-point values or a scalar single-precision floating-point value.
- The `__m128d` data type holds two packed double-precision floating-point values or a scalar double-precision floating-point value.
- The `__m128i` data type can hold sixteen byte, eight word, or four doubleword, or two quadword integer values.

The compiler aligns `__m128`, `__m128d`, and `__m128i` local and global data to 16-byte boundaries on the stack. To align integer, float, or double arrays, use the `declspec` statement as described in Intel C/C++ compiler documentation. See <http://www.intel.com/support/performance/tools/>.

The `__m128`, `__m128d`, and `__m128i` data types are not basic ANSI C data types and therefore some restrictions are placed on its usage:

- Use `__m128`, `__m128d`, and `__m128i` only on the left-hand side of an assignment, as a return value, or as a parameter. Do not use it in other arithmetic expressions such as “+” and “>>.”
- Do not initialize `__m128`, `__m128d`, and `__m128i` with literals; there is no way to express 128-bit constants.
- Use `__m128`, `__m128d`, and `__m128i` objects in aggregates, such as unions (for example, to access the float elements) and structures. The address of these objects may be taken.
- Use `__m128`, `__m128d`, and `__m128i` data only with the intrinsics described in this user’s guide. See Appendix C, “Intel® C/C++ Compiler Intrinsics and Functional Equivalents,” in the *Intel® 64 and IA-32 Architectures Software Developer’s Manual, Volume 2B*, for more information on using intrinsics.

The compiler aligns `__m128`, `__m128d`, and `__m128i` local data to 16-byte boundaries on the stack. Global `__m128` data is also aligned on 16-byte boundaries. (To align float arrays, you can use the alignment `declspec` described in the following section.) Because the new instruction set treats the SIMD floating-point registers in the same way whether you are using packed or scalar data, there is no `__m32` data type to represent scalar data as you might expect. For scalar operations, you should use the `__m128` objects and the “scalar” forms of the intrinsics; the compiler and the processor implement these operations with 32-bit memory references.

The suffixes `ps` and `ss` are used to denote “packed single” and “scalar single” precision operations. The packed floats are represented in right-to-left order, with the lowest word (right-most) being used for scalar operations: `[z, y, x, w]`. To explain how memory storage reflects this, consider the following example.

The operation:

```
float a[4] ← { 1.0, 2.0, 3.0, 4.0 };
__m128 t ← _mm_load_ps(a);
```

Produces the same result as follows:

```
__m128 t ← _mm_set_ps(4.0, 3.0, 2.0, 1.0);
```

In other words:

```
t ← [ 4.0, 3.0, 2.0, 1.0 ]
```

Where the “scalar” element is 1.0.

Some intrinsics are “composites” because they require more than one instruction to implement them. You should be familiar with the hardware features provided by the SSE, SSE2, SSE3, and MMX technology when writing programs with the intrinsics.

Keep the following important issues in mind:

- Certain intrinsics, such as `_mm_loadr_ps` and `_mm_cmpgt_ss`, are not directly supported by the instruction set. While these intrinsics are convenient programming aids, be mindful of their implementation cost.
- Data loaded or stored as `__m128` objects must generally be 16-byte-aligned.
- Some intrinsics require that their argument be immediates, that is, constant integers (literals), due to the nature of the instruction.
- The result of arithmetic operations acting on two NaN (Not a Number) arguments is undefined. Therefore, floating-point operations using NaN arguments may not match the expected behavior of the corresponding assembly instructions.

For a more detailed description of each intrinsic and additional information related to its usage, refer to Intel C/C++ compiler documentation. See:

- <http://www.intel.com/support/performance/tools/>
- Appendix C, “Intel® C/C++ Compiler Intrinsics and Functional Equivalents,” in the *Intel® 64 and IA-32 Architectures Software Developer’s Manual, Volume 2B*, for more information on using intrinsics.

3.1.1.9 Flags Affected Section

The “Flags Affected” section lists the flags in the EFLAGS register that are affected by the instruction. When a flag is cleared, it is equal to 0; when it is set, it is equal to 1. The arithmetic and logical instructions usually assign values to the status flags in a uniform manner (see Appendix A, “Eflags Cross-Reference,” in the *Intel® 64 and IA-32 Architectures Software Developer’s Manual, Volume 1*). Non-conventional assignments are described in the “Operation” section. The values of flags listed as **undefined** may be changed by the instruction in an indeterminate manner. Flags that are not listed are unchanged by the instruction.

3.1.1.10 FPU Flags Affected Section

The floating-point instructions have an “FPU Flags Affected” section that describes how each instruction can affect the four condition code flags of the FPU status word.

3.1.1.11 Protected Mode Exceptions Section

The “Protected Mode Exceptions” section lists the exceptions that can occur when the instruction is executed in protected mode and the reasons for the exceptions. Each exception is given a mnemonic that consists of a pound sign (#) followed by two letters and an optional error code in parentheses. For example, #GP(0) denotes a general protection exception with an error code of 0. Table 3-3 associates each two-letter mnemonic with the corresponding interrupt vector number and exception name. See Chapter 6, “Interrupt and Exception Handling,” in the *Intel® 64 and IA-32 Architectures Software Developer’s Manual, Volume 3A*, for a detailed description of the exceptions.

Application programmers should consult the documentation provided with their operating systems to determine the actions taken when exceptions occur.

Table 3-3. Intel 64 and IA-32 General Exceptions

Vector No.	Name	Source	Protected Mode ⁷	Real Address Mode	Virtual 8086 Mode
0	#DE—Divide Error	DIV and IDIV instructions.	Yes	Yes	Yes
1	#DB—Debug	Any code or data reference.	Yes	Yes	Yes
3	#BP—Breakpoint	INT 3 instruction.	Yes	Yes	Yes
4	#OF—Overflow	INTO instruction.	Yes	Yes	Yes
5	#BR—BOUND Range Exceeded	BOUND instruction.	Yes	Yes	Yes
6	#UD—Invalid Opcode (Undefined Opcode)	UD2 instruction or reserved opcode.	Yes	Yes	Yes
7	#NM—Device Not Available (No Math Coprocessor)	Floating-point or WAIT/FWAIT instruction.	Yes	Yes	Yes
8	#DF—Double Fault	Any instruction that can generate an exception, an NMI, or an INTR.	Yes	Yes	Yes
10	#TS—Invalid TSS	Task switch or TSS access.	Yes	Reserved	Yes
11	#NP—Segment Not Present	Loading segment registers or accessing system segments.	Yes	Reserved	Yes
12	#SS—Stack Segment Fault	Stack operations and SS register loads.	Yes	Yes	Yes
13	#GP—General Protection ²	Any memory reference and other protection checks.	Yes	Yes	Yes

Table 3-3. Intel 64 and IA-32 General Exceptions (Contd.)

Vector No.	Name	Source	Protected Mode ⁷	Real Address Mode	Virtual 8086 Mode
14	#PF—Page Fault	Any memory reference.	Yes	Reserved	Yes
16	#MF—Floating-Point Error (Math Fault)	Floating-point or WAIT/FWAIT instruction.	Yes	Yes	Yes
17	#AC—Alignment Check	Any data reference in memory.	Yes	Reserved	Yes
18	#MC—Machine Check	Model dependent machine check errors.	Yes	Yes	Yes
19	#XM—SIMD Floating-Point Numeric Error	SSE/SSE2/SSE3 floating-point instructions.	Yes	Yes	Yes

NOTES:

1. Apply to protected mode, compatibility mode, and 64-bit mode.
2. In the real-address mode, vector 13 is the segment overrun exception.

3.1.1.12 Real-Address Mode Exceptions Section

The “Real-Address Mode Exceptions” section lists the exceptions that can occur when the instruction is executed in real-address mode (see Table 3-3).

3.1.1.13 Virtual-8086 Mode Exceptions Section

The “Virtual-8086 Mode Exceptions” section lists the exceptions that can occur when the instruction is executed in virtual-8086 mode (see Table 3-3).

3.1.1.14 Floating-Point Exceptions Section

The “Floating-Point Exceptions” section lists exceptions that can occur when an x87 FPU floating-point instruction is executed. All of these exception conditions result in a floating-point error exception (#MF, vector number 16) being generated. Table 3-4 associates a one- or two-letter mnemonic with the corresponding exception name. See “Floating-Point Exception Conditions” in Chapter 8 of the *Intel® 64 and IA-32 Architectures Software Developer’s Manual, Volume 1*, for a detailed description of these exceptions.

Table 3-4. x87 FPU Floating-Point Exceptions

Mnemonic	Name	Source
#IS #IA	Floating-point invalid operation: - Stack overflow or underflow - Invalid arithmetic operation	- x87 FPU stack overflow or underflow - Invalid FPU arithmetic operation
#Z	Floating-point divide-by-zero	Divide-by-zero
#D	Floating-point denormal operand	Source operand that is a denormal number
#O	Floating-point numeric overflow	Overflow in result
#U	Floating-point numeric underflow	Underflow in result
#P	Floating-point inexact result (precision)	Inexact result (precision)

3.1.1.15 SIMD Floating-Point Exceptions Section

The “SIMD Floating-Point Exceptions” section lists exceptions that can occur when an SSE/SSE2/SSE3 floating-point instruction is executed. All of these exception conditions result in a SIMD floating-point error exception (#XM, vector number 19) being generated. Table 3-5 associates a one-letter mnemonic with the corresponding exception name. For a detailed description of these exceptions, refer to “SSE and SSE2 Exceptions”, in Chapter 11 of the *Intel® 64 and IA-32 Architectures Software Developer’s Manual, Volume 1*.

Table 3-5. SIMD Floating-Point Exceptions

Mnemonic	Name	Source
#I	Floating-point invalid operation	Invalid arithmetic operation or source operand
#Z	Floating-point divide-by-zero	Divide-by-zero
#D	Floating-point denormal operand	Source operand that is a denormal number
#O	Floating-point numeric overflow	Overflow in result
#U	Floating-point numeric underflow	Underflow in result
#P	Floating-point inexact result	Inexact result (precision)

3.1.1.16 Compatibility Mode Exceptions Section

This section lists exception that occur within compatibility mode.

3.1.1.17 64-Bit Mode Exceptions Section

This section lists exception that occur within 64-bit mode.

3.1.2 Imm8 Control Byte Operation for PCMPESTRI / PCMPESTRM / PCMPISTRI / PCMPISTRM

The notations introduced in this section are referenced in the reference pages of PCMPESTRI, PCMPESTRM, PCMPISTRI, PCMPISTRM. The operation of the immediate control byte is common to these four string text processing instructions of SSE4.2, see Chapter 4, “Instruction Set Reference, N-Z,”. This section describes the common operations.

3.1.2.1 General Description

The operation of PCMPESTRI, PCMPESTRM, PCMPISTRI, PCMPISTRM is defined by the combination of the respective opcode and the interpretation of an immediate control byte that is part of the instruction encoding.

The opcode controls the relationship of input bytes/words to each other (determines whether the inputs terminated strings or whether lengths are expressed explicitly) as well as the desired output (index or mask).

The Imm8 Control Byte for PCMPESTRM/PCMPESTRI/PCMPISTRM/PCMPISTRI encodes a significant amount of programmable control over the functionality of those instructions. Some functionality is unique to each instruction while some is common across some or all of the four instructions. This section describes functionality which is common across the four instructions.

The arithmetic flags (ZF, CF, SF, OF, AF, PF) are set as a result of these instructions. However, the meanings of the flags have been overloaded from their typical meanings in order to provide additional information regarding the relationships of the two inputs.

PCMPxSTRx instructions perform arithmetic comparisons between all possible pairs of bytes or words, one from each packed input source operand. The boolean results of those comparisons are then aggregated in order to produce meaningful results. The Imm8 Control Byte is used to affect the interpretation of individual input elements as well as control the arithmetic comparisons used and the specific aggregation scheme.

Specifically, the Imm8 Control Byte consists of bit fields that control the following attributes:

- **Source data format** — Byte/word data element granularity, signed or unsigned elements
- **Aggregation operation** — Encodes the mode of per-element comparison operation and the aggregation of per-element comparisons into an intermediate result

- **Polarity** — Specifies intermediate processing to be performed on the intermediate result
- **Output selection** — Specifies final operation to produce the output (depending on index or mask) from the intermediate result

3.1.2.2 Source Data Format

Table 3-6. Source Data Format

Imm8[1:0]	Meaning	Description
00b	Unsigned bytes	Both 128-bit sources are treated as packed, unsigned bytes.
01b	Unsigned words	Both 128-bit sources are treated as packed, unsigned words.
10b	Signed bytes	Both 128-bit sources are treated as packed, signed bytes.
11b	Signed words	Both 128-bit sources are treated as packed, signed words.

If the Imm8 Control Byte has bit[0] cleared, each source contains 16 packed bytes. If the bit is set each source contains 8 packed words. If the Imm8 Control Byte has bit[1] cleared, each input contains unsigned data. If the bit is set each source contains signed data.

3.1.2.3 Aggregation Operation

Table 3-7. Aggregation Operation

Imm8[3:2]	Mode	Comparison
00b	Equal any	The arithmetic comparison is "equal."
01b	Ranges	Arithmetic comparison is "greater than or equal" between even indexed bytes/words of reg and each byte/word of reg/mem. Arithmetic comparison is "less than or equal" between odd indexed bytes/words of reg and each byte/word of reg/mem. (reg/mem[m] >= reg[n] for n = even, reg/mem[m] <= reg[n] for n = odd)
10b	Equal each	The arithmetic comparison is "equal."
11b	Equal ordered	The arithmetic comparison is "equal."

All 256 (64) possible comparisons are always performed. The individual Boolean results of those comparisons are referred to by "BoolRes[Reg/Mem element index, Reg element index]." Comparisons evaluating to "True" are represented with a 1, False with a 0 (positive logic). The initial results are then aggregated into a 16-bit (8-bit) intermediate result (IntRes1) using one of the modes described in the table below, as determined by Imm8 Control Byte bit[3:2].

See Section 3.1.2.6 for a description of the `overrideIfDataInvalid()` function used in Table 3-8.

Table 3-8. Aggregation Operation

Mode	Pseudocode
Equal any (find characters from a set)	<pre> UpperBound = imm8[0] ? 7 : 15; IntRes1 = 0; For j = 0 to UpperBound, j++ For i = 0 to UpperBound, i++ IntRes1[j] OR= overrideIfDataInvalid(BoolRes[j,i]) </pre>
Ranges (find characters from ranges)	<pre> UpperBound = imm8[0] ? 7 : 15; IntRes1 = 0; For j = 0 to UpperBound, j++ For i = 0 to UpperBound, i+=2 IntRes1[j] OR= (overrideIfDataInvalid(BoolRes[j,i]) AND overrideIfDataInvalid(BoolRes[j,i+1])) </pre>
Equal each (string compare)	<pre> UpperBound = imm8[0] ? 7 : 15; IntRes1 = 0; For i = 0 to UpperBound, i++ IntRes1[i] = overrideIfDataInvalid(BoolRes[i,i]) </pre>
Equal ordered (substring search)	<pre> UpperBound = imm8[0] ? 7 : 15; IntRes1 = imm8[0] ? 0xFF : 0xFFFF For j = 0 to UpperBound, j++ For i = 0 to UpperBound-j, k=j to UpperBound, k++, i++ IntRes1[j] AND= overrideIfDataInvalid(BoolRes[k,i]) </pre>

3.1.2.4 Polarity

IntRes1 may then be further modified by performing a 1's compliment, according to the value of the Imm8 Control Byte bit[4]. Optionally, a mask may be used such that only those IntRes1 bits which correspond to "valid" reg/mem input elements are complimented (note that the definition of a valid input element is dependant on the specific opcode and is defined in each opcode's description). The result of the possible negation is referred to as IntRes2.

Table 3-9. Polarity

Imm8[5:4]	Operation	Description
00b	Positive Polarity (+)	IntRes2 = IntRes1
01b	Negative Polarity (-)	IntRes2 = -1 XOR IntRes1
10b	Masked (+)	IntRes2 = IntRes1
11b	Masked (-)	IntRes2[i] = IntRes1[i] if reg/mem[i] invalid, else = ~IntRes1[i]

3.1.2.5 Output Selection

Table 3-10. Output Selection

Imm8[6]	Operation	Description
0b	Least significant index	The index returned to ECX is of the least significant set bit in IntRes2.
1b	Most significant index	The index returned to ECX is of the most significant set bit in IntRes2.

For PCMPESTR1/PCMPISTR1, the Imm8 Control Byte bit[6] is used to determine if the index is of the least significant or most significant bit of IntRes2.

Table 3-11. Output Selection

Imm8[6]	Operation	Description
0b	Bit mask	IntRes2 is returned as the mask to the least significant bits of XMM0 with zero extension to 128 bits.
1b	Byte/word mask	IntRes2 is expanded into a byte/word mask (based on imm8[1]) and placed in XMM0. The expansion is performed by replicating each bit into all of the bits of the byte/word of the same index.

Specifically for PCMPESTRM/PCMPISTRM, the Imm8 Control Byte bit[6] is used to determine if the mask is a 16 (8) bit mask or a 128 bit byte/word mask.

3.1.2.6 Valid/Invalid Override of Comparisons

PCMPxSTRx instructions allow for the possibility that an end-of-string (EOS) situation may occur within the 128-bit packed data value (see the instruction descriptions

below for details). Any data elements on either source that are determined to be past the EOS are considered to be invalid, and the treatment of invalid data within a comparison pair varies depending on the aggregation function being performed.

In general, the individual comparison result for each element pair $\text{BoolRes}[i,j]$ can be forced true or false if one or more elements in the pair are invalid. See Table 3-12.

Table 3-12. Comparison Result for Each Element Pair $\text{BoolRes}[i,j]$

xmm1 byte/ word	xmm2/ m128 byte/word	Imm8[3:2] = 00b (equal any)	Imm8[3:2] = 01b (ranges)	Imm8[3:2] = 10b (equal each)	Imm8[3:2] = 11b (equal ordered)
Invalid	Invalid	Force false	Force false	Force true	Force true
Invalid	Valid	Force false	Force false	Force false	Force true
Valid	Invalid	Force false	Force false	Force false	Force false
Valid	Valid	Do not force	Do not force	Do not force	Do not force

3.1.2.7 Summary of Im8 Control byte

Table 3-13. Summary of Imm8 Control Byte

Imm8	Description
-----0b	128-bit sources treated as 16 packed bytes.
-----1b	128-bit sources treated as 8 packed words.
-----0-b	Packed bytes/words are unsigned.
-----1-b	Packed bytes/words are signed.
----00--b	Mode is equal any.
----01--b	Mode is ranges.
----10--b	Mode is equal each.
----11--b	Mode is equal ordered.
---0----b	IntRes1 is unmodified.
---1----b	IntRes1 is negated (1's compliment).
--0-----b	Negation of IntRes1 is for all 16 (8) bits.
--1-----b	Negation of IntRes1 is masked by reg/mem validity.
-0-----b	Index of the least significant, set, bit is used (regardless of corresponding input element validity). IntRes2 is returned in least significant bits of XMM0.

Table 3-13. Summary of Imm8 Control Byte (Contd.)

-1-----b	Index of the most significant, set, bit is used (regardless of corresponding input element validity). Each bit of IntRes2 is expanded to byte/word.
0-----b	This bit currently has no defined effect, should be 0.
1-----b	This bit currently has no defined effect, should be 0.

3.1.2.8 Diagram Comparison and Aggregation Process

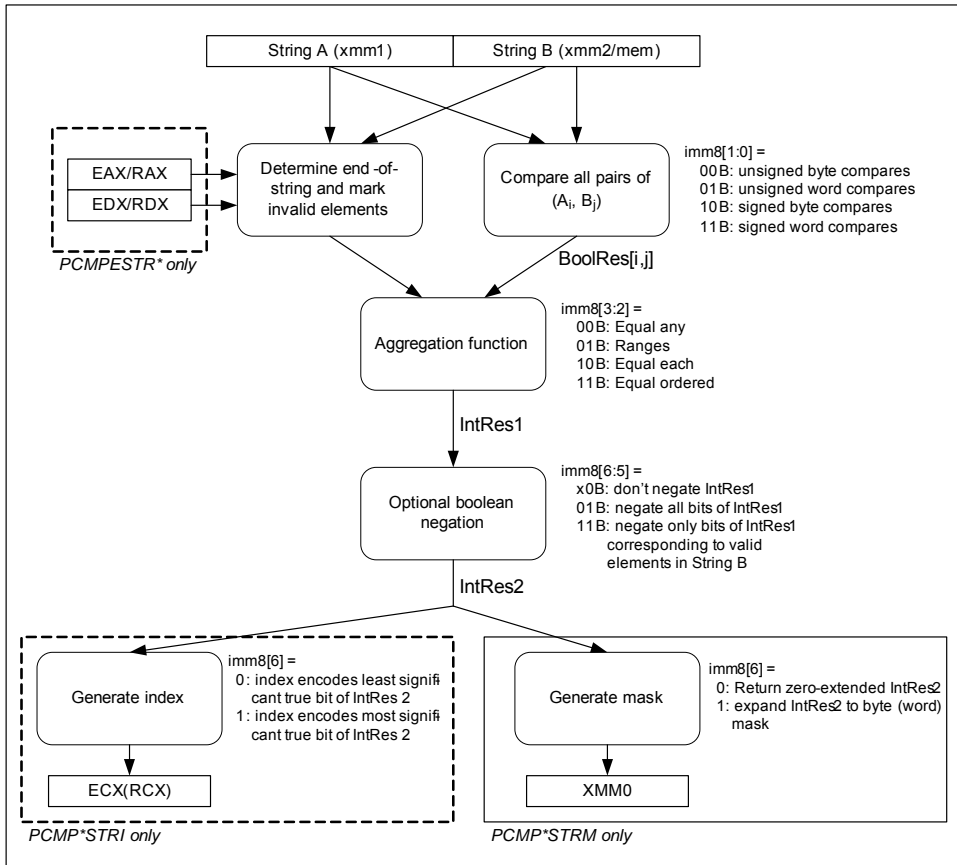

Figure 3-3. Operation of PCMPSTRx and PCMPSTRx

3.2 INSTRUCTIONS (A-M)

The remainder of this chapter provides descriptions of Intel 64 and IA-32 instructions (A-M). See also: Chapter 4, "Instruction Set Reference, N-Z," in the *Intel® 64 and IA-32 Architectures Software Developer's Manual, Volume 2B*.

AAA—ASCII Adjust After Addition

Opcode	Instruction	64-Bit Mode	Compat/ Leg Mode	Description
37	AAA	Invalid	Valid	ASCII adjust AL after addition.

Description

Adjusts the sum of two unpacked BCD values to create an unpacked BCD result. The AL register is the implied source and destination operand for this instruction. The AAA instruction is only useful when it follows an ADD instruction that adds (binary addition) two unpacked BCD values and stores a byte result in the AL register. The AAA instruction then adjusts the contents of the AL register to contain the correct 1-digit unpacked BCD result.

If the addition produces a decimal carry, the AH register increments by 1, and the CF and AF flags are set. If there was no decimal carry, the CF and AF flags are cleared and the AH register is unchanged. In either case, bits 4 through 7 of the AL register are set to 0.

This instruction executes as described in compatibility mode and legacy mode. It is not valid in 64-bit mode.

Operation

```
IF 64-Bit Mode
  THEN
    #UD;
  ELSE
    IF ((AL AND 0FH) > 9) or (AF = 1)
      THEN
        AL ← AL + 6;
        AH ← AH + 1;
        AF ← 1;
        CF ← 1;
        AL ← AL AND 0FH;
      ELSE
        AF ← 0;
        CF ← 0;
        AL ← AL AND 0FH;
    FI;
  FI;
```

Flags Affected

The AF and CF flags are set to 1 if the adjustment results in a decimal carry; otherwise they are set to 0. The OF, SF, ZF, and PF flags are undefined.

Protected Mode Exceptions

#UD If the LOCK prefix is used.

Real-Address Mode Exceptions

Same exceptions as protected mode.

Virtual-8086 Mode Exceptions

Same exceptions as protected mode.

Compatibility Mode Exceptions

Same exceptions as protected mode.

64-Bit Mode Exceptions

#UD If in 64-bit mode.

AAD—ASCII Adjust AX Before Division

Opcode	Instruction	64-Bit Mode	Compat/ Leg Mode	Description
D5 0A	AAD	Invalid	Valid	ASCII adjust AX before division.
D5 <i>ib</i>	(No mnemonic)	Invalid	Valid	Adjust AX before division to number base <i>imm8</i> .

Description

Adjusts two unpacked BCD digits (the least-significant digit in the AL register and the most-significant digit in the AH register) so that a division operation performed on the result will yield a correct unpacked BCD value. The AAD instruction is only useful when it precedes a DIV instruction that divides (binary division) the adjusted value in the AX register by an unpacked BCD value.

The AAD instruction sets the value in the AL register to $(AL + (10 * AH))$, and then clears the AH register to 00H. The value in the AX register is then equal to the binary equivalent of the original unpacked two-digit (base 10) number in registers AH and AL.

The generalized version of this instruction allows adjustment of two unpacked digits of any number base (see the “Operation” section below), by setting the *imm8* byte to the selected number base (for example, 08H for octal, 0AH for decimal, or 0CH for base 12 numbers). The AAD mnemonic is interpreted by all assemblers to mean adjust ASCII (base 10) values. To adjust values in another number base, the instruction must be hand coded in machine code (D5 *imm8*).

This instruction executes as described in compatibility mode and legacy mode. It is not valid in 64-bit mode.

Operation

```
IF 64-Bit Mode
  THEN
    #UD;
  ELSE
    tempAL ← AL;
    tempAH ← AH;
    AL ← (tempAL + (tempAH * imm8)) AND FFH;
    (* imm8 is set to 0AH for the AAD mnemonic.*)
    AH ← 0;
FI;
```

The immediate value (*imm8*) is taken from the second byte of the instruction.

Flags Affected

The SF, ZF, and PF flags are set according to the resulting binary value in the AL register; the OF, AF, and CF flags are undefined.

Protected Mode Exceptions

#UD If the LOCK prefix is used.

Real-Address Mode Exceptions

Same exceptions as protected mode.

Virtual-8086 Mode Exceptions

Same exceptions as protected mode.

Compatibility Mode Exceptions

Same exceptions as protected mode.

64-Bit Mode Exceptions

#UD If in 64-bit mode.

AAM—ASCII Adjust AX After Multiply

Opcode	Instruction	64-Bit Mode	Compat/ Leg Mode	Description
D4 0A	AAM	Invalid	Valid	ASCII adjust AX after multiply.
D4 <i>ib</i>	(No mnemonic)	Invalid	Valid	Adjust AX after multiply to number base <i>imm8</i> .

Description

Adjusts the result of the multiplication of two unpacked BCD values to create a pair of unpacked (base 10) BCD values. The AX register is the implied source and destination operand for this instruction. The AAM instruction is only useful when it follows an MUL instruction that multiplies (binary multiplication) two unpacked BCD values and stores a word result in the AX register. The AAM instruction then adjusts the contents of the AX register to contain the correct 2-digit unpacked (base 10) BCD result.

The generalized version of this instruction allows adjustment of the contents of the AX to create two unpacked digits of any number base (see the “Operation” section below). Here, the *imm8* byte is set to the selected number base (for example, 08H for octal, 0AH for decimal, or 0CH for base 12 numbers). The AAM mnemonic is interpreted by all assemblers to mean adjust to ASCII (base 10) values. To adjust to values in another number base, the instruction must be hand coded in machine code (D4 *imm8*).

This instruction executes as described in compatibility mode and legacy mode. It is not valid in 64-bit mode.

Operation

```
IF 64-Bit Mode
  THEN
    #UD;
  ELSE
    tempAL ← AL;
    AH ← tempAL / imm8; (* imm8 is set to 0AH for the AAM mnemonic *)
    AL ← tempAL MOD imm8;
FI;
```

The immediate value (*imm8*) is taken from the second byte of the instruction.

Flags Affected

The SF, ZF, and PF flags are set according to the resulting binary value in the AL register. The OF, AF, and CF flags are undefined.

Protected Mode Exceptions

- #DE If an immediate value of 0 is used.
- #UD If the LOCK prefix is used.

Real-Address Mode Exceptions

Same exceptions as protected mode.

Virtual-8086 Mode Exceptions

Same exceptions as protected mode.

Compatibility Mode Exceptions

Same exceptions as protected mode.

64-Bit Mode Exceptions

- #UD If in 64-bit mode.

AAS—ASCII Adjust AL After Subtraction

Opcode	Instruction	64-Bit Mode	Compat/Leg Mode	Description
3F	AAS	Invalid	Valid	ASCII adjust AL after subtraction.

Description

Adjusts the result of the subtraction of two unpacked BCD values to create a unpacked BCD result. The AL register is the implied source and destination operand for this instruction. The AAS instruction is only useful when it follows a SUB instruction that subtracts (binary subtraction) one unpacked BCD value from another and stores a byte result in the AL register. The AAA instruction then adjusts the contents of the AL register to contain the correct 1-digit unpacked BCD result.

If the subtraction produced a decimal carry, the AH register decrements by 1, and the CF and AF flags are set. If no decimal carry occurred, the CF and AF flags are cleared, and the AH register is unchanged. In either case, the AL register is left with its top four bits set to 0.

This instruction executes as described in compatibility mode and legacy mode. It is not valid in 64-bit mode.

Operation

```
IF 64-bit mode
  THEN
    #UD;
  ELSE
    IF ((AL AND 0FH) > 9) or (AF = 1)
      THEN
        AL ← AL - 6;
        AH ← AH - 1;
        AF ← 1;
        CF ← 1;
        AL ← AL AND 0FH;
      ELSE
        CF ← 0;
        AF ← 0;
        AL ← AL AND 0FH;
    FI;
  FI;
```

Flags Affected

The AF and CF flags are set to 1 if there is a decimal borrow; otherwise, they are cleared to 0. The OF, SF, ZF, and PF flags are undefined.

Protected Mode Exceptions

#UD If the LOCK prefix is used.

Real-Address Mode Exceptions

Same exceptions as protected mode.

Virtual-8086 Mode Exceptions

Same exceptions as protected mode.

Compatibility Mode Exceptions

Same exceptions as protected mode.

64-Bit Mode Exceptions

#UD If in 64-bit mode.

ADC—Add with Carry

Opcode	Instruction	64-Bit Mode	Compat/ Leg Mode	Description
14 <i>ib</i>	ADC AL, <i>imm8</i>	Valid	Valid	Add with carry <i>imm8</i> to AL.
15 <i>iw</i>	ADC AX, <i>imm16</i>	Valid	Valid	Add with carry <i>imm16</i> to AX.
15 <i>id</i>	ADC EAX, <i>imm32</i>	Valid	Valid	Add with carry <i>imm32</i> to EAX.
REX.W + 15 <i>id</i>	ADC RAX, <i>imm32</i>	Valid	N.E.	Add with carry <i>imm32</i> sign extended to 64-bits to RAX.
80 /2 <i>ib</i>	ADC <i>r/m8</i> , <i>imm8</i>	Valid	Valid	Add with carry <i>imm8</i> to <i>r/m8</i> .
REX + 80 /2 <i>ib</i>	ADC <i>r/m8</i> *, <i>imm8</i>	Valid	N.E.	Add with carry <i>imm8</i> to <i>r/m8</i> .
81 /2 <i>iw</i>	ADC <i>r/m16</i> , <i>imm16</i>	Valid	Valid	Add with carry <i>imm16</i> to <i>r/m16</i> .
81 /2 <i>id</i>	ADC <i>r/m32</i> , <i>imm32</i>	Valid	Valid	Add with CF <i>imm32</i> to <i>r/m32</i> .
REX.W + 81 /2 <i>id</i>	ADC <i>r/m64</i> , <i>imm32</i>	Valid	N.E.	Add with CF <i>imm32</i> sign extended to 64-bits to <i>r/m64</i> .
83 /2 <i>ib</i>	ADC <i>r/m16</i> , <i>imm8</i>	Valid	Valid	Add with CF sign-extended <i>imm8</i> to <i>r/m16</i> .
83 /2 <i>ib</i>	ADC <i>r/m32</i> , <i>imm8</i>	Valid	Valid	Add with CF sign-extended <i>imm8</i> into <i>r/m32</i> .
REX.W + 83 /2 <i>ib</i>	ADC <i>r/m64</i> , <i>imm8</i>	Valid	N.E.	Add with CF sign-extended <i>imm8</i> into <i>r/m64</i> .
10 / <i>r</i>	ADC <i>r/m8</i> , <i>r8</i>	Valid	Valid	Add with carry byte register to <i>r/m8</i> .
REX + 10 / <i>r</i>	ADC <i>r/m8</i> *, <i>r8</i> *	Valid	N.E.	Add with carry byte register to <i>r/m64</i> .
11 / <i>r</i>	ADC <i>r/m16</i> , <i>r16</i>	Valid	Valid	Add with carry <i>r16</i> to <i>r/m16</i> .
11 / <i>r</i>	ADC <i>r/m32</i> , <i>r32</i>	Valid	Valid	Add with CF <i>r32</i> to <i>r/m32</i> .
REX.W + 11 / <i>r</i>	ADC <i>r/m64</i> , <i>r64</i>	Valid	N.E.	Add with CF <i>r64</i> to <i>r/m64</i> .
12 / <i>r</i>	ADC <i>r8</i> , <i>r/m8</i>	Valid	Valid	Add with carry <i>r/m8</i> to byte register.
REX + 12 / <i>r</i>	ADC <i>r8</i> *, <i>r/m8</i> *	Valid	N.E.	Add with carry <i>r/m64</i> to byte register.
13 / <i>r</i>	ADC <i>r16</i> , <i>r/m16</i>	Valid	Valid	Add with carry <i>r/m16</i> to <i>r16</i> .

Opcode	Instruction	64-Bit Mode	Compat/Leg Mode	Description
13 /r	ADC <i>r32, r/m32</i>	Valid	Valid	Add with CF <i>r/m32</i> to <i>r32</i> .
REX.W + 13 /r	ADC <i>r64, r/m64</i>	Valid	N.E.	Add with CF <i>r/m64</i> to <i>r64</i> .

NOTES:

- * In 64-bit mode, *r/m8* can not be encoded to access the following byte registers if a REX prefix is used: AH, BH, CH, DH.

Description

Adds the destination operand (first operand), the source operand (second operand), and the carry (CF) flag and stores the result in the destination operand. The destination operand can be a register or a memory location; the source operand can be an immediate, a register, or a memory location. (However, two memory operands cannot be used in one instruction.) The state of the CF flag represents a carry from a previous addition. When an immediate value is used as an operand, it is sign-extended to the length of the destination operand format.

The ADC instruction does not distinguish between signed or unsigned operands. Instead, the processor evaluates the result for both data types and sets the OF and CF flags to indicate a carry in the signed or unsigned result, respectively. The SF flag indicates the sign of the signed result.

The ADC instruction is usually executed as part of a multibyte or multiword addition in which an ADD instruction is followed by an ADC instruction.

This instruction can be used with a LOCK prefix to allow the instruction to be executed atomically.

In 64-bit mode, the instruction's default operation size is 32 bits. Using a REX prefix in the form of REX.R permits access to additional registers (R8-R15). Using a REX prefix in the form of REX.W promotes operation to 64 bits. See the summary chart at the beginning of this section for encoding data and limits.

Operation

DEST ← DEST + SRC + CF;

Flags Affected

The OF, SF, ZF, AF, CF, and PF flags are set according to the result.

Protected Mode Exceptions

- #GP(0) If the destination is located in a non-writable segment.
- If a memory operand effective address is outside the CS, DS, ES, FS, or GS segment limit.

	If the DS, ES, FS, or GS register is used to access memory and it contains a NULL segment selector.
#SS(0)	If a memory operand effective address is outside the SS segment limit.
#PF(fault-code)	If a page fault occurs.
#AC(0)	If alignment checking is enabled and an unaligned memory reference is made while the current privilege level is 3.
#UD	If the LOCK prefix is used but the destination is not a memory operand.

Real-Address Mode Exceptions

#GP	If a memory operand effective address is outside the CS, DS, ES, FS, or GS segment limit.
#SS	If a memory operand effective address is outside the SS segment limit.
#UD	If the LOCK prefix is used but the destination is not a memory operand.

Virtual-8086 Mode Exceptions

#GP(0)	If a memory operand effective address is outside the CS, DS, ES, FS, or GS segment limit.
#SS(0)	If a memory operand effective address is outside the SS segment limit.
#PF(fault-code)	If a page fault occurs.
#AC(0)	If alignment checking is enabled and an unaligned memory reference is made.
#UD	If the LOCK prefix is used but the destination is not a memory operand.

Compatibility Mode Exceptions

Same exceptions as in protected mode.

64-Bit Mode Exceptions

#SS(0)	If a memory address referencing the SS segment is in a non-canonical form.
#GP(0)	If the memory address is in a non-canonical form.
#PF(fault-code)	If a page fault occurs.
#AC(0)	If alignment checking is enabled and an unaligned memory reference is made while the current privilege level is 3.
#UD	If the LOCK prefix is used but the destination is not a memory operand.

ADD—Add

Opcode	Instruction	64-Bit Mode	Compat/ Leg Mode	Description
04 <i>ib</i>	ADD AL, <i>imm8</i>	Valid	Valid	Add <i>imm8</i> to AL.
05 <i>iw</i>	ADD AX, <i>imm16</i>	Valid	Valid	Add <i>imm16</i> to AX.
05 <i>id</i>	ADD EAX, <i>imm32</i>	Valid	Valid	Add <i>imm32</i> to EAX.
REX.W + 05 <i>id</i>	ADD RAX, <i>imm32</i>	Valid	N.E.	Add <i>imm32</i> sign-extended to 64-bits to RAX.
80 /0 <i>ib</i>	ADD <i>r/m8</i> , <i>imm8</i>	Valid	Valid	Add <i>imm8</i> to <i>r/m8</i> .
REX + 80 /0 <i>ib</i>	ADD <i>r/m8</i> [*] , <i>imm8</i>	Valid	N.E.	Add sign-extended <i>imm8</i> to <i>r/m64</i> .
81 /0 <i>iw</i>	ADD <i>r/m16</i> , <i>imm16</i>	Valid	Valid	Add <i>imm16</i> to <i>r/m16</i> .
81 /0 <i>id</i>	ADD <i>r/m32</i> , <i>imm32</i>	Valid	Valid	Add <i>imm32</i> to <i>r/m32</i> .
REX.W + 81 /0 <i>id</i>	ADD <i>r/m64</i> , <i>imm32</i>	Valid	N.E.	Add <i>imm32</i> sign-extended to 64-bits to <i>r/m64</i> .
83 /0 <i>ib</i>	ADD <i>r/m16</i> , <i>imm8</i>	Valid	Valid	Add sign-extended <i>imm8</i> to <i>r/m16</i> .
83 /0 <i>ib</i>	ADD <i>r/m32</i> , <i>imm8</i>	Valid	Valid	Add sign-extended <i>imm8</i> to <i>r/m32</i> .
REX.W + 83 /0 <i>ib</i>	ADD <i>r/m64</i> , <i>imm8</i>	Valid	N.E.	Add sign-extended <i>imm8</i> to <i>r/m64</i> .
00 / <i>r</i>	ADD <i>r/m8</i> , <i>r8</i>	Valid	Valid	Add <i>r8</i> to <i>r/m8</i> .
REX + 00 / <i>r</i>	ADD <i>r/m8</i> [*] , <i>r8</i> [*]	Valid	N.E.	Add <i>r8</i> to <i>r/m8</i> .
01 / <i>r</i>	ADD <i>r/m16</i> , <i>r16</i>	Valid	Valid	Add <i>r16</i> to <i>r/m16</i> .
01 / <i>r</i>	ADD <i>r/m32</i> , <i>r32</i>	Valid	Valid	Add <i>r32</i> to <i>r/m32</i> .
REX.W + 01 / <i>r</i>	ADD <i>r/m64</i> , <i>r64</i>	Valid	N.E.	Add <i>r64</i> to <i>r/m64</i> .
02 / <i>r</i>	ADD <i>r8</i> , <i>r/m8</i>	Valid	Valid	Add <i>r/m8</i> to <i>r8</i> .
REX + 02 / <i>r</i>	ADD <i>r8</i> [*] , <i>r/m8</i> [*]	Valid	N.E.	Add <i>r/m8</i> to <i>r8</i> .
03 / <i>r</i>	ADD <i>r16</i> , <i>r/m16</i>	Valid	Valid	Add <i>r/m16</i> to <i>r16</i> .
03 / <i>r</i>	ADD <i>r32</i> , <i>r/m32</i>	Valid	Valid	Add <i>r/m32</i> to <i>r32</i> .
REX.W + 03 / <i>r</i>	ADD <i>r64</i> , <i>r/m64</i>	Valid	N.E.	Add <i>r/m64</i> to <i>r64</i> .

NOTES:

* In 64-bit mode, *r/m8* can not be encoded to access the following byte registers if a REX prefix is used: AH, BH, CH, DH.

Description

Adds the destination operand (first operand) and the source operand (second operand) and then stores the result in the destination operand. The destination operand can be a register or a memory location; the source operand can be an immediate, a register, or a memory location. (However, two memory operands cannot be used in one instruction.) When an immediate value is used as an operand, it is sign-extended to the length of the destination operand format.

The ADD instruction performs integer addition. It evaluates the result for both signed and unsigned integer operands and sets the OF and CF flags to indicate a carry (overflow) in the signed or unsigned result, respectively. The SF flag indicates the sign of the signed result.

This instruction can be used with a LOCK prefix to allow the instruction to be executed atomically.

In 64-bit mode, the instruction's default operation size is 32 bits. Using a REX prefix in the form of REX.R permits access to additional registers (R8-R15). Using a REX a REX prefix in the form of REX.W promotes operation to 64 bits. See the summary chart at the beginning of this section for encoding data and limits.

Operation

DEST ← DEST + SRC;

Flags Affected

The OF, SF, ZF, AF, CF, and PF flags are set according to the result.

Protected Mode Exceptions

#GP(0)	If the destination is located in a non-writable segment. If a memory operand effective address is outside the CS, DS, ES, FS, or GS segment limit. If the DS, ES, FS, or GS register is used to access memory and it contains a NULL segment selector.
#SS(0)	If a memory operand effective address is outside the SS segment limit.
#PF(fault-code)	If a page fault occurs.
#AC(0)	If alignment checking is enabled and an unaligned memory reference is made while the current privilege level is 3.
#UD	If the LOCK prefix is used but the destination is not a memory operand.

Real-Address Mode Exceptions

#GP	If a memory operand effective address is outside the CS, DS, ES, FS, or GS segment limit.
-----	-------------------------------------------------------------------------------------------

#SS	If a memory operand effective address is outside the SS segment limit.
#UD	If the LOCK prefix is used but the destination is not a memory operand.

Virtual-8086 Mode Exceptions

#GP(0)	If a memory operand effective address is outside the CS, DS, ES, FS, or GS segment limit.
#SS(0)	If a memory operand effective address is outside the SS segment limit.
#PF(fault-code)	If a page fault occurs.
#AC(0)	If alignment checking is enabled and an unaligned memory reference is made.
#UD	If the LOCK prefix is used but the destination is not a memory operand.

Compatibility Mode Exceptions

Same exceptions as in protected mode.

64-Bit Mode Exceptions

#SS(0)	If a memory address referencing the SS segment is in a non-canonical form.
#GP(0)	If the memory address is in a non-canonical form.
#PF(fault-code)	If a page fault occurs.
#AC(0)	If alignment checking is enabled and an unaligned memory reference is made while the current privilege level is 3.
#UD	If the LOCK prefix is used but the destination is not a memory operand.

ADDPD—Add Packed Double-Precision Floating-Point Values

Opcode	Instruction	64-Bit Mode	Compat/Leg Mode	Description
66 0F 58 /r	ADDPD <i>xmm1</i> , <i>xmm2/m128</i>	Valid	Valid	Add packed double-precision floating-point values from <i>xmm2/m128</i> to <i>xmm1</i> .

Description

Performs a SIMD add of the two packed double-precision floating-point values from the source operand (second operand) and the destination operand (first operand), and stores the packed double-precision floating-point results in the destination operand.

The source operand can be an XMM register or a 128-bit memory location. The destination operand is an XMM register. See Chapter 11 in the *Intel® 64 and IA-32 Architectures Software Developer's Manual, Volume 1*, for an overview of SIMD double-precision floating-point operation.

In 64-bit mode, using a REX prefix in the form of REX.R permits this instruction to access additional registers (XMM8-XMM15).

Operation

```
DEST[63:0] ← DEST[63:0] + SRC[63:0];
DEST[127:64] ← DEST[127:64] + SRC[127:64];
```

Intel C/C++ Compiler Intrinsic Equivalent

```
ADDPD    __m128d _mm_add_pd (m128d a, m128d b)
```

SIMD Floating-Point Exceptions

Overflow, Underflow, Invalid, Precision, Denormal.

Protected Mode Exceptions

- #GP(0) For an illegal memory operand effective address in the CS, DS, ES, FS or GS segments.
If a memory operand is not aligned on a 16-byte boundary, regardless of segment.
- #SS(0) For an illegal address in the SS segment.
- #PF(fault-code) For a page fault.
- #NM If CR0.TS[bit 3] = 1.
- #XM If an unmasked SIMD floating-point exception and CR4.OSXMMEXCPT[bit 10] = 1.

#UD	<p>If an unmasked SIMD floating-point exception and CR4.OSXMMEXCPT[bit 10] = 0.</p> <p>If CR0.EM[bit 2] = 1.</p> <p>If CR4.OSFXSR[bit 9] = 0.</p> <p>If CPUID.01H:EDX.SSE2[bit 26] = 0.</p> <p>If the LOCK prefix is used.</p>
-----	--------------------------------------------------------------------------------------------------------------------------------------------------------------------------------------------------------------------------------

Real-Address Mode Exceptions

#GP	<p>If a memory operand is not aligned on a 16-byte boundary, regardless of segment.</p> <p>If any part of the operand lies outside the effective address space from 0 to FFFFH.</p>
#NM	If CR0.TS[bit 3] = 1.
#XM	<p>If an unmasked SIMD floating-point exception and CR4.OSXMMEXCPT[bit 10] = 1.</p>
#UD	<p>If an unmasked SIMD floating-point exception and CR4.OSXMMEXCPT[bit 10] = 0.</p> <p>If CR0.EM[bit 2] = 1.</p> <p>If CR4.OSFXSR[bit 9] = 0.</p> <p>If CPUID.01H:EDX.SSE2[bit 26] = 0.</p> <p>If the LOCK prefix is used.</p>

Virtual-8086 Mode Exceptions

Same exceptions as in real address mode.

#PF(fault-code)	For a page fault.
-----------------	-------------------

Compatibility Mode Exceptions

Same exceptions as in protected mode.

64-Bit Mode Exceptions

#SS(0)	If a memory address referencing the SS segment is in a non-canonical form.
#GP(0)	<p>If the memory address is in a non-canonical form.</p> <p>If memory operand is not aligned on a 16-byte boundary, regardless of segment.</p>
#PF(fault-code)	For a page fault.
#NM	If CR0.TS[bit 3] = 1.
#XM	If an unmasked SIMD floating-point exception and CR4.OSXMMEXCPT[bit 10] = 1.

#UD

If an unmasked SIMD floating-point exception and CR4.OSXMMEXCPT[bit 10] = 0.
If CR0.EM[bit 2] = 1.
If CR4.OSFXSR[bit 9] = 0.
If CPUID.01H: EDX.SSE2[bit 26] = 0.
If the LOCK prefix is used.

ADDPS—Add Packed Single-Precision Floating-Point Values

Opcode	Instruction	64-Bit Mode	Compat/ Leg Mode	Description
OF 5B /r	ADDPS <i>xmm1, xmm2/m128</i>	Valid	Valid	Add packed single-precision floating-point values from <i>xmm2/m128</i> to <i>xmm1</i> .

Description

Performs a SIMD add of the four packed single-precision floating-point values from the source operand (second operand) and the destination operand (first operand), and stores the packed single-precision floating-point results in the destination operand.

The source operand can be an XMM register or a 128-bit memory location. The destination operand is an XMM register. See Chapter 10 in the *Intel® 64 and IA-32 Architectures Software Developer's Manual, Volume 1*, for an overview of SIMD single-precision floating-point operation.

In 64-bit mode, using a REX prefix in the form of REX.R permits this instruction to access additional registers (XMM8-XMM15).

Operation

```
DEST[31:0] ← DEST[31:0] + SRC[31:0];
DEST[63:32] ← DEST[63:32] + SRC[63:32];
DEST[95:64] ← DEST[95:64] + SRC[95:64];
DEST[127:96] ← DEST[127:96] + SRC[127:96];
```

Intel C/C++ Compiler Intrinsic Equivalent

```
ADDPS    __m128 __mm_add_ps(__m128 a, __m128 b)
```

SIMD Floating-Point Exceptions

Overflow, Underflow, Invalid, Precision, Denormal.

Protected Mode Exceptions

#GP(0)	For an illegal memory operand effective address in the CS, DS, ES, FS or GS segments. If a memory operand is not aligned on a 16-byte boundary, regardless of segment.
#SS(0)	For an illegal address in the SS segment.
#PF(fault-code)	For a page fault.
#NM	If CR0.TS[bit 3] = 1.

#XM	If an unmasked SIMD floating-point exception and CR4.OSXMMEXCPT[bit 10] = 1.
#UD	If an unmasked SIMD floating-point exception and CR4.OSXMMEXCPT[bit 10] = 0. If CR0.EM[bit 2] = 1. If CR4.OSFXSR[bit 9] = 0. If CPUID.01H: EDX.SSE[bit 25] = 0. If the LOCK prefix is used.

Real-Address Mode Exceptions

#GP	If a memory operand is not aligned on a 16-byte boundary, regardless of segment. If any part of the operand lies outside the effective address space from 0 to FFFFH.
#NM	If CR0.TS[bit 3] = 1.
#XM	If an unmasked SIMD floating-point exception and CR4.OSXMMEXCPT[bit 10] = 1.
#UD	If an unmasked SIMD floating-point exception and CR4.OSXMMEXCPT[bit 10] = 0. If CR0.EM[bit 2] = 1. If CR4.OSFXSR[bit 9] = 0. If CPUID.01H: EDX.SSE[bit 25] = 0. If the LOCK prefix is used.

Virtual-8086 Mode Exceptions

Same exceptions as in real address mode.

#PF(fault-code) For a page fault.

Compatibility Mode Exceptions

Same exceptions as in protected mode.

64-Bit Mode Exceptions

#SS(0)	If a memory address referencing the SS segment is in a non-canonical form.
#GP(0)	If the memory address is in a non-canonical form. If memory operand is not aligned on a 16-byte boundary, regardless of segment.
#PF(fault-code)	For a page fault.
#NM	If CR0.TS[bit 3] = 1.

#XM	If an unmasked SIMD floating-point exception and CR4.OSXMMEXCPT[bit 10] = 1.
#UD	If an unmasked SIMD floating-point exception and CR4.OSXMMEXCPT[bit 10] = 0. If CR0.EM[bit 2] = 1. If CR4.OSFXSR[bit 9] = 0. If CPUID.01H: EDX.SSE[bit 25] = 0. If the LOCK prefix is used.

ADDSD—Add Scalar Double-Precision Floating-Point Values

Opcode	Instruction	64-Bit Mode	Compat/ Leg Mode	Description
F2 0F 58 /r	ADDSD <i>xmm1</i> , <i>xmm2/m64</i>	Valid	Valid	Add the low double-precision floating-point value from <i>xmm2/m64</i> to <i>xmm1</i> .

Description

Adds the low double-precision floating-point values from the source operand (second operand) and the destination operand (first operand), and stores the double-precision floating-point result in the destination operand.

The source operand can be an XMM register or a 64-bit memory location. The destination operand is an XMM register. The high quadword of the destination operand remains unchanged. See Chapter 11 in the *Intel® 64 and IA-32 Architectures Software Developer's Manual, Volume 1*, for an overview of a scalar double-precision floating-point operation.

In 64-bit mode, using a REX prefix in the form of REX.R permits this instruction to access additional registers (XMM8-XMM15).

Operation

DEST[63:0] ← DEST[63:0] + SRC[63:0];
 (* DEST[127:64] unchanged *)

Intel C/C++ Compiler Intrinsic Equivalent

ADDSD __m128d _mm_add_sd (m128d a, m128d b)

SIMD Floating-Point Exceptions

Overflow, Underflow, Invalid, Precision, Denormal.

Protected Mode Exceptions

- #GP(0) For an illegal memory operand effective address in the CS, DS, ES, FS or GS segments.
- #SS(0) For an illegal address in the SS segment.
- #PF(fault-code) For a page fault.
- #NM If CR0.TS[bit 3] = 1.
- #XM If an unmasked SIMD floating-point exception and CR4.OSXMMEXCPT[bit 10] = 1.

#UD	If an unmasked SIMD floating-point exception and CR4.OSXMMEXCPT[bit 10] = 0. If CR0.EM[bit 2] = 1. If CR4.OSFXSR[bit 9] = 0. If CPUID.01H:EDX.SSE2[bit 26] = 0. If the LOCK prefix is used.
#AC(0)	If alignment checking is enabled and an unaligned memory reference is made while the current privilege level is 3.

Real-Address Mode Exceptions

GP	If any part of the operand lies outside the effective address space from 0 to FFFFH.
#NM	If CR0.TS[bit 3] = 1.
#XM	If an unmasked SIMD floating-point exception and CR4.OSXMMEXCPT[bit 10] = 1.
#UD	If an unmasked SIMD floating-point exception and CR4.OSXMMEXCPT[bit 10] = 0. If CR0.EM[bit 2] = 1. If CR4.OSFXSR[bit 9] = 0. If CPUID.01H:EDX.SSE2[bit 26] = 0. If the LOCK prefix is used.

Virtual-8086 Mode Exceptions

Same exceptions as in real address mode.

#PF(fault-code)	For a page fault.
#AC(0)	If alignment checking is enabled and an unaligned memory reference is made.

Compatibility Mode Exceptions

Same exceptions as in protected mode.

64-Bit Mode Exceptions

#SS(0)	If a memory address referencing the SS segment is in a non-canonical form.
#GP(0)	If the memory address is in a non-canonical form.
#PF(fault-code)	For a page fault.
#NM	If CR0.TS[bit 3] = 1.
#XM	If an unmasked SIMD floating-point exception and CR4.OSXMMEXCPT[bit 10] = 1.

#UD	If an unmasked SIMD floating-point exception and CR4.OSXMMEXCPT[bit 10] = 0. If CR0.EM[bit 2] = 1. If CR4.OSFXSR[bit 9] = 0. If CPUID.01H:EDX.SSE2[bit 26] = 0. If the LOCK prefix is used.
#AC(0)	If alignment checking is enabled and an unaligned memory reference is made while the current privilege level is 3.

ADDSS—Add Scalar Single-Precision Floating-Point Values

Opcode	Instruction	64-Bit Mode	Compat/Leg Mode	Description
F3 0F 58 /r	ADDSS <i>xmm1</i> , <i>xmm2/m32</i>	Valid	Valid	Add the low single-precision floating-point value from <i>xmm2/m32</i> to <i>xmm1</i> .

Description

Adds the low single-precision floating-point values from the source operand (second operand) and the destination operand (first operand), and stores the single-precision floating-point result in the destination operand.

The source operand can be an XMM register or a 32-bit memory location. The destination operand is an XMM register. The three high-order doublewords of the destination operand remain unchanged. See Chapter 10 in the *Intel® 64 and IA-32 Architectures Software Developer's Manual, Volume 1*, for an overview of a scalar single-precision floating-point operation.

In 64-bit mode, using a REX prefix in the form of REX.R permits this instruction to access additional registers (XMM8-XMM15).

Operation

DEST[31:0] ← DEST[31:0] + SRC[31:0];
 (* DEST[127:32] unchanged *)

Intel C/C++ Compiler Intrinsic Equivalent

ADDSS __m128 _mm_add_ss(__m128 a, __m128 b)

SIMD Floating-Point Exceptions

Overflow, Underflow, Invalid, Precision, Denormal.

Protected Mode Exceptions

#GP(0)	For an illegal memory operand effective address in the CS, DS, ES, FS or GS segments.
#SS(0)	For an illegal address in the SS segment.
#PF(fault-code)	For a page fault.
#NM	If CR0.TS[bit 3] = 1.
#XM	If an unmasked SIMD floating-point exception and CR4.OSXMMEXCPT[bit 10] = 1.

#UD	<p>If an unmasked SIMD floating-point exception and CR4.OSXMMEXCPT[bit 10] = 0.</p> <p>If CR0.EM[bit 2] = 1.</p> <p>If CR4.OSFXSR[bit 9] = 0.</p> <p>If CPUID.01H:EDX.SSE[bit 25] = 0.</p> <p>If the LOCK prefix is used.</p>
#AC(0)	<p>If alignment checking is enabled and an unaligned memory reference is made while the current privilege level is 3.</p>

Real-Address Mode Exceptions

GP	<p>If any part of the operand lies outside the effective address space from 0 to FFFFH.</p>
#NM	<p>If CR0.TS[bit 3] = 1.</p>
#XM	<p>If an unmasked SIMD floating-point exception and CR4.OSXMMEXCPT[bit 10] = 1.</p>
#UD	<p>If an unmasked SIMD floating-point exception and CR4.OSXMMEXCPT[bit 10] = 0.</p> <p>If CR0.EM[bit 2] = 1.</p> <p>If CR4.OSFXSR[bit 9] = 0.</p> <p>If CPUID.01H:EDX.SSE[bit 25] = 0.</p> <p>If the LOCK prefix is used.</p>

Virtual-8086 Mode Exceptions

Same exceptions as in real address mode.

#PF(fault-code)	<p>For a page fault.</p>
#AC(0)	<p>If alignment checking is enabled and an unaligned memory reference is made.</p>

Compatibility Mode Exceptions

Same exceptions as in protected mode.

64-Bit Mode Exceptions

#SS(0)	<p>If a memory address referencing the SS segment is in a non-canonical form.</p>
#GP(0)	<p>If the memory address is in a non-canonical form.</p>
#PF(fault-code)	<p>For a page fault.</p>
#NM	<p>If CR0.TS[bit 3] = 1.</p>
#XM	<p>If an unmasked SIMD floating-point exception and CR4.OSXMMEXCPT[bit 10] = 1.</p>

#UD	<p>If an unmasked SIMD floating-point exception and CR4.OSXMMEXCPT[bit 10] = 0.</p> <p>If CR0.EM[bit 2] = 1.</p> <p>If CR4.OSFXSR[bit 9] = 0.</p> <p>If CPUID.01H: EDX.SSE[bit 25] = 0.</p> <p>If the LOCK prefix is used.</p>
#AC(0)	<p>If alignment checking is enabled and an unaligned memory reference is made while the current privilege level is 3.</p>

ADDSUBPD—Packed Double-FP Add/Subtract

Opcode	Instruction	64-Bit Mode	Compat/ Leg Mode	Description
66 0F D0 /r	ADDSUBPD <i>xmm1</i> , <i>xmm2/m128</i>	Valid	Valid	Add/subtract double-precision floating-point values from <i>xmm2/m128</i> to <i>xmm1</i> .

Description

Adds the double-precision floating-point values in the high quadword of the source and destination operands and stores the result in the high quadword of the destination operand.

Subtracts the double-precision floating-point value in the low quadword of the source operand from the low quadword of the destination operand and stores the result in the low quadword of the destination operand. See Figure 3-4.

The source operand can be a 128-bit memory location or an XMM register. The destination operand is an XMM register.

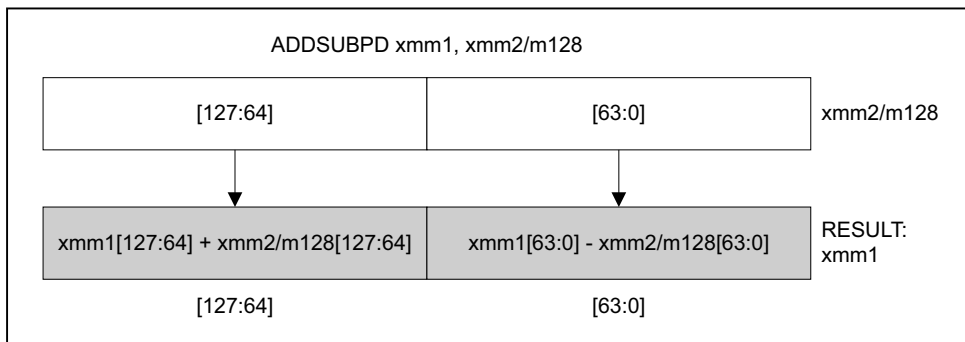

OM15991

Figure 3-4. ADDSUBPD—Packed Double-FP Add/Subtract

In 64-bit mode, using a REX prefix in the form of REX.R permits this instruction to access additional registers (XMM8-XMM15).

Operation

$xmm1[63:0] = xmm1[63:0] - xmm2/m128[63:0];$
 $xmm1[127:64] = xmm1[127:64] + xmm2/m128[127:64];$

Intel C/C++ Compiler Intrinsic Equivalent

ADDSUBPD `__m128d _mm_addsub_pd(__m128d a, __m128d b)`

Exceptions

When the source operand is a memory operand, it must be aligned on a 16-byte boundary or a general-protection exception (#GP) will be generated.

SIMD Floating-Point Exceptions

Overflow, Underflow, Invalid, Precision, Denormal.

Protected Mode Exceptions

#GP(0)	For an illegal memory operand effective address in the CS, DS, ES, FS or GS segments. If a memory operand is not aligned on a 16-byte boundary, regardless of segment.
#SS(0)	For an illegal address in the SS segment.
#PF(fault-code)	For a page fault.
#NM	If CR0.TS[bit 3] = 1.
#XM	For an unmasked Streaming SIMD Extensions numeric exception, CR4.OSXMMEXCPT[bit 10] = 1.
#UD	If CR0.EM is 1. For an unmasked Streaming SIMD Extensions numeric exception (CR4.OSXMMEXCPT[bit 10] = 0). If CR4.OSFXSR[bit 9] = 0. If CPUID.01H: ECX.SSE3[bit 0] = 0. If the LOCK prefix is used.

Real Address Mode Exceptions

GP(0)	If any part of the operand would lie outside of the effective address space from 0 to 0FFFFH. If a memory operand is not aligned on a 16-byte boundary, regardless of segment.
#NM	If TS bit in CR0 is 1.
#XM	For an unmasked Streaming SIMD Extensions numeric exception, CR4.OSXMMEXCPT[bit 10] = 1.

#UD	<p>If CR0.EM[bit 2] = 1.</p> <p>For an unmasked Streaming SIMD Extensions numeric exception (CR4.OSXMMEXCPT[bit 10] = 0).</p> <p>If CR4.OSFXSR[bit 9] = 0.</p> <p>If CPUID.01H: ECX.SSE3[bit 0] = 0.</p> <p>If the LOCK prefix is used.</p>
-----	---------------------------------------------------------------------------------------------------------------------------------------------------------------------------------------------------------------------------------------------

Virtual 8086 Mode Exceptions

GP(0)	<p>If any part of the operand would lie outside of the effective address space from 0 to 0FFFFH.</p> <p>If a memory operand is not aligned on a 16-byte boundary, regardless of segment.</p>
#NM	If CR0.TS[bit 3] = 1.
#XM	For an unmasked Streaming SIMD Extensions numeric exception, CR4.OSXMMEXCPT[bit 10] = 1.
#UD	<p>If CR0.EM[bit 2] = 1.</p> <p>For an unmasked Streaming SIMD Extensions numeric exception (CR4.OSXMMEXCPT[bit 10] = 0).</p> <p>If CR4.OSFXSR[bit 9] = 0.</p> <p>If CPUID.01H: ECX.SSE3[bit 0] = 0.</p> <p>If the LOCK prefix is used.</p>
#PF(fault-code)	For a page fault.

Compatibility Mode Exceptions

Same exceptions as in protected mode.

64-Bit Mode Exceptions

#SS(0)	If a memory address referencing the SS segment is in a non-canonical form.
#GP(0)	<p>If the memory address is in a non-canonical form.</p> <p>If memory operand is not aligned on a 16-byte boundary, regardless of segment.</p>
#PF(fault-code)	For a page fault.
#NM	If CR0.TS[bit 3] = 1.
#XM	If an unmasked SIMD floating-point exception and CR4.OSXMMEXCPT[bit 10] = 1.

#UD

If an unmasked SIMD floating-point exception and CR4.OSXMMEXCPT[bit 10] = 0.

If CR0.EM[bit 2] = 1.

If CR4.OSFXSR[bit 9] = 0.

If CPUID.01H: ECX.SSE3[bit 0] = 0.

If the LOCK prefix is used.

ADDSUBPS—Packed Single-FP Add/Subtract

Opcode	Instruction	64-Bit Mode	Compat/Leg Mode	Description
F2 0F D0 /r	ADDSUBPS <i>xmm1</i> , <i>xmm2/m128</i>	Valid	Valid	Add/subtract single-precision floating-point values from <i>xmm2/m128</i> to <i>xmm1</i> .

Description

Adds odd-numbered single-precision floating-point values of the source operand (second operand) with the corresponding single-precision floating-point values from the destination operand (first operand); stores the result in the odd-numbered values of the destination operand.

Subtracts the even-numbered single-precision floating-point values in the source operand from the corresponding single-precision floating-point values in the destination operand; stores the result into the even-numbered values of the destination operand.

The source operand can be a 128-bit memory location or an XMM register. The destination operand is an XMM register. See Figure 3-5.

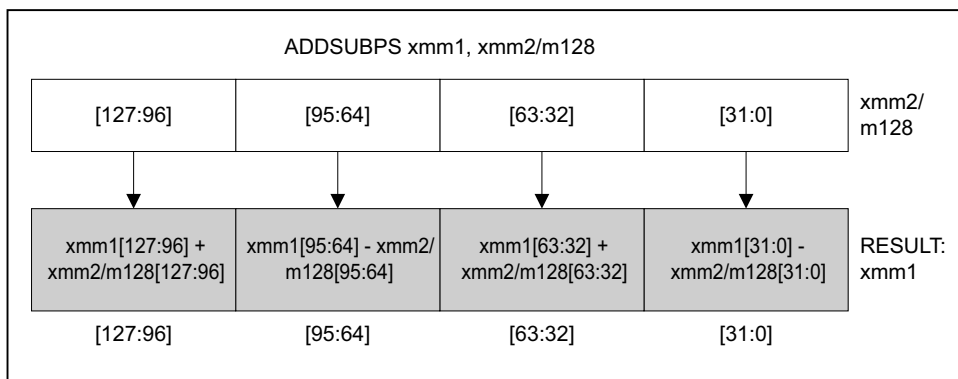

OM15992

Figure 3-5. ADDSUBPS—Packed Single-FP Add/Subtract

In 64-bit mode, using a REX prefix in the form of REX.R permits this instruction to access additional registers (XMM8-XMM15).

Operation

```
xmm1[31:0] = xmm1[31:0] - xmm2/m128[31:0];
xmm1[63:32] = xmm1[63:32] + xmm2/m128[63:32];
xmm1[95:64] = xmm1[95:64] - xmm2/m128[95:64];
xmm1[127:96] = xmm1[127:96] + xmm2/m128[127:96];
```

Intel C/C++ Compiler Intrinsic Equivalent

```
ADDSUBPS    __m128 _mm_addsub_ps(__m128 a, __m128 b)
```

Exceptions

When the source operand is a memory operand, the operand must be aligned on a 16-byte boundary or a general-protection exception (#GP) will be generated.

SIMD Floating-Point Exceptions

Overflow, Underflow, Invalid, Precision, Denormal.

Protected Mode Exceptions

#GP(0)	For an illegal memory operand effective address in the CS, DS, ES, FS or GS segments. If a memory operand is not aligned on a 16-byte boundary, regardless of segment.
#SS(0)	For an illegal address in the SS segment.
#PF(fault-code)	For a page fault.
#NM	If CR0.TS[bit 3] = 1.
#XM	For an unmasked Streaming SIMD Extensions numeric exception, CR4.OSXMMEXCPT[bit 10] = 1.
#UD	If CR0.EM[bit 2] = 1. For an unmasked Streaming SIMD Extensions numeric exception (CR4.OSXMMEXCPT[bit 10] = 0). If CR4.OSFXSR[bit 9] = 0. If CPUID.01H:ECX.SSE3[bit 0] = 0. If the LOCK prefix is used.

Real Address Mode Exceptions

GP(0)	If any part of the operand would lie outside of the effective address space from 0 to 0FFFFH. If a memory operand is not aligned on a 16-byte boundary, regardless of segment.
#NM	If CR0.TS[bit 3] = 1.

#XM	For an unmasked Streaming SIMD Extensions numeric exception, CR4.OSXMMEXCPT[bit 10] = 1.
#UD	If CR0.EM[bit 2] = 1. For an unmasked Streaming SIMD Extensions numeric exception (CR4.OSXMMEXCPT[bit 10] = 0). If CR4.OSFXSR[bit 9] = 0. If CPUID.01H: ECX.SSE3[bit 0] = 0. If the LOCK prefix is used.

Virtual 8086 Mode Exceptions

GP(0)	If any part of the operand would lie outside of the effective address space from 0 to 0FFFFH. If a memory operand is not aligned on a 16-byte boundary, regardless of segment.
#NM	If CR0.TS[bit 3] = 1.
#XM	For an unmasked Streaming SIMD Extensions numeric exception, CR4.OSXMMEXCPT[bit 10] = 1.
#UD	If CR0.EM[bit 2] = 1. For an unmasked Streaming SIMD Extensions numeric exception (CR4.OSXMMEXCPT[bit 10] = 0). If CR4.OSFXSR[bit 9] = 0. If CPUID.01H: ECX.SSE3[bit 0] = 0. If the LOCK prefix is used.

Compatibility Mode Exceptions

Same exceptions as in protected mode.

64-Bit Mode Exceptions

#SS(0)	If a memory address referencing the SS segment is in a non-canonical form.
#GP(0)	If the memory address is in a non-canonical form. If memory operand is not aligned on a 16-byte boundary, regardless of segment.
#PF(fault-code)	For a page fault.
#NM	If CR0.TS[bit 3] = 1.
#XM	If an unmasked SIMD floating-point exception and CR4.OSXMMEXCPT[bit 10] = 1.

#UD

If an unmasked SIMD floating-point exception and CR4.OSXMMEXCPT[bit 10] = 0.

If CR0.EM[bit 2] = 1.

If CR4.OSFXSR[bit 9] = 0.

If CPUID.01H: ECX.SSE3[bit 0] = 0.

If the LOCK prefix is used.

AND—Logical AND

Opcode	Instruction	64-Bit Mode	Comp/Leg Mode	Description
24 <i>ib</i>	AND AL, <i>imm8</i>	Valid	Valid	AL AND <i>imm8</i> .
25 <i>iw</i>	AND AX, <i>imm16</i>	Valid	Valid	AX AND <i>imm16</i> .
25 <i>id</i>	AND EAX, <i>imm32</i>	Valid	Valid	EAX AND <i>imm32</i> .
REX.W + 25 <i>id</i>	AND RAX, <i>imm32</i>	Valid	N.E.	RAX AND <i>imm32</i> sign-extended to 64-bits.
80 /4 <i>ib</i>	AND <i>r/m8</i> , <i>imm8</i>	Valid	Valid	<i>r/m8</i> AND <i>imm8</i> .
REX + 80 /4 <i>ib</i>	AND <i>r/m8</i> [*] , <i>imm8</i>	Valid	N.E.	<i>r/m64</i> AND <i>imm8</i> (sign-extended).
81 /4 <i>iw</i>	AND <i>r/m16</i> , <i>imm16</i>	Valid	Valid	<i>r/m16</i> AND <i>imm16</i> .
81 /4 <i>id</i>	AND <i>r/m32</i> , <i>imm32</i>	Valid	Valid	<i>r/m32</i> AND <i>imm32</i> .
REX.W + 81 /4 <i>id</i>	AND <i>r/m64</i> , <i>imm32</i>	Valid	N.E.	<i>r/m64</i> AND <i>imm32</i> sign-extended to 64-bits.
83 /4 <i>ib</i>	AND <i>r/m16</i> , <i>imm8</i>	Valid	Valid	<i>r/m16</i> AND <i>imm8</i> (sign-extended).
83 /4 <i>ib</i>	AND <i>r/m32</i> , <i>imm8</i>	Valid	Valid	<i>r/m32</i> AND <i>imm8</i> (sign-extended).
REX.W + 83 /4 <i>ib</i>	AND <i>r/m64</i> , <i>imm8</i>	Valid	N.E.	<i>r/m64</i> AND <i>imm8</i> (sign-extended).
20 /r	AND <i>r/m8</i> , <i>r8</i>	Valid	Valid	<i>r/m8</i> AND <i>r8</i> .
REX + 20 /r	AND <i>r/m8</i> [*] , <i>r8</i> [*]	Valid	N.E.	<i>r/m64</i> AND <i>r8</i> (sign-extended).
21 /r	AND <i>r/m16</i> , <i>r16</i>	Valid	Valid	<i>r/m16</i> AND <i>r16</i> .
21 /r	AND <i>r/m32</i> , <i>r32</i>	Valid	Valid	<i>r/m32</i> AND <i>r32</i> .
REX.W + 21 /r	AND <i>r/m64</i> , <i>r64</i>	Valid	N.E.	<i>r/m64</i> AND <i>r32</i> .
22 /r	AND <i>r8</i> , <i>r/m8</i>	Valid	Valid	<i>r8</i> AND <i>r/m8</i> .
REX + 22 /r	AND <i>r8</i> [*] , <i>r/m8</i> [*]	Valid	N.E.	<i>r/m64</i> AND <i>r8</i> (sign-extended).
23 /r	AND <i>r16</i> , <i>r/m16</i>	Valid	Valid	<i>r16</i> AND <i>r/m16</i> .
23 /r	AND <i>r32</i> , <i>r/m32</i>	Valid	Valid	<i>r32</i> AND <i>r/m32</i> .
REX.W + 23 /r	AND <i>r64</i> , <i>r/m64</i>	Valid	N.E.	<i>r64</i> AND <i>r/m64</i> .

NOTES:

* In 64-bit mode, *r/m8* can not be encoded to access the following byte registers if a REX prefix is used: AH, BH, CH, DH.

Description

Performs a bitwise AND operation on the destination (first) and source (second) operands and stores the result in the destination operand location. The source operand can be an immediate, a register, or a memory location; the destination operand can be a register or a memory location. (However, two memory operands cannot be used in one instruction.) Each bit of the result is set to 1 if both corresponding bits of the first and second operands are 1; otherwise, it is set to 0.

This instruction can be used with a LOCK prefix to allow the it to be executed atomically.

In 64-bit mode, the instruction's default operation size is 32 bits. Using a REX prefix in the form of REX.R permits access to additional registers (R8-R15). Using a REX prefix in the form of REX.W promotes operation to 64 bits. See the summary chart at the beginning of this section for encoding data and limits.

Operation

DEST ← DEST AND SRC;

Flags Affected

The OF and CF flags are cleared; the SF, ZF, and PF flags are set according to the result. The state of the AF flag is undefined.

Protected Mode Exceptions

#GP(0)	If the destination operand points to a non-writable segment. If a memory operand effective address is outside the CS, DS, ES, FS, or GS segment limit. If the DS, ES, FS, or GS register contains a NULL segment selector.
#SS(0)	If a memory operand effective address is outside the SS segment limit.
#PF(fault-code)	If a page fault occurs.
#AC(0)	If alignment checking is enabled and an unaligned memory reference is made while the current privilege level is 3.
#UD	If the LOCK prefix is used but the destination is not a memory operand.

Real-Address Mode Exceptions

#GP	If a memory operand effective address is outside the CS, DS, ES, FS, or GS segment limit.
#SS	If a memory operand effective address is outside the SS segment limit.

#UD If the LOCK prefix is used but the destination is not a memory operand.

Virtual-8086 Mode Exceptions

#GP(0) If a memory operand effective address is outside the CS, DS, ES, FS, or GS segment limit.

#SS(0) If a memory operand effective address is outside the SS segment limit.

#PF(fault-code) If a page fault occurs.

#AC(0) If alignment checking is enabled and an unaligned memory reference is made.

#UD If the LOCK prefix is used but the destination is not a memory operand.

Compatibility Mode Exceptions

Same exceptions as in protected mode.

64-Bit Mode Exceptions

#SS(0) If a memory address referencing the SS segment is in a non-canonical form.

#GP(0) If the memory address is in a non-canonical form.

#PF(fault-code) If a page fault occurs.

#AC(0) If alignment checking is enabled and an unaligned memory reference is made while the current privilege level is 3.

#UD If the LOCK prefix is used but the destination is not a memory operand.

ANDPD—Bitwise Logical AND of Packed Double-Precision Floating-Point Values

Opcode	Instruction	64-Bit Mode	Compat/ Leg Mode	Description
66 0F 54 /r	ANDPD <i>xmm1</i> , <i>xmm2/m128</i>	Valid	Valid	Bitwise logical AND of <i>xmm2/m128</i> and <i>xmm1</i> .

Description

Performs a bitwise logical AND of the two packed double-precision floating-point values from the source operand (second operand) and the destination operand (first operand), and stores the result in the destination operand.

The source operand can be an XMM register or a 128-bit memory location. The destination operand is an XMM register.

In 64-bit mode, using a REX prefix in the form of REX.R permits this instruction to access additional registers (XMM8-XMM15).

Operation

DEST[127:0] ← DEST[127:0] BitwiseAND SRC[127:0];

Intel C/C++ Compiler Intrinsic Equivalent

ANDPD `__m128d __mm_and_pd(__m128d a, __m128d b)`

SIMD Floating-Point Exceptions

None.

Protected Mode Exceptions

#GP(0)	For an illegal memory operand effective address in the CS, DS, ES, FS or GS segments. If a memory operand is not aligned on a 16-byte boundary, regardless of segment.
#SS(0)	For an illegal address in the SS segment.
#PF(fault-code)	For a page fault.
#NM	If CR0.TS[bit 3] = 1.
#UD	If CR0.EM[bit 2] = 1. If CR4.OSFXSR[bit 9] = 0. If CPUID.01H:EDX.SSE2[bit 26] = 0. If the LOCK prefix is used.

Real-Address Mode Exceptions

#GP	If a memory operand is not aligned on a 16-byte boundary, regardless of segment. If any part of the operand lies outside the effective address space from 0 to FFFFH.
#NM	If CR0.TS[bit 3] = 1.
#UD	If CR0.EM[bit 2] = 1. If CR4.OSFXSR[bit 9] = 0. If CPUID.01H: EDX.SSE2[bit 26] = 0. If the LOCK prefix is used.

Virtual-8086 Mode Exceptions

Same exceptions as in real address mode.

#PF(fault-code)	For a page fault.
-----------------	-------------------

Compatibility Mode Exceptions

Same exceptions as in protected mode.

64-Bit Mode Exceptions

#SS(0)	If a memory address referencing the SS segment is in a non-canonical form.
#GP(0)	If the memory address is in a non-canonical form. If memory operand is not aligned on a 16-byte boundary, regardless of segment.
#PF(fault-code)	For a page fault.
#NM	If CR0.TS[bit 3] = 1.
#UD	If CR0.EM[bit 2] = 1. If CR4.OSFXSR[bit 9] = 0. If CPUID.01H: EDX.SSE2[bit 26] = 0. If the LOCK prefix is used.

ANDPS—Bitwise Logical AND of Packed Single-Precision Floating-Point Values

Opcode	Instruction	64-Bit Mode	Compat/ Leg Mode	Description
OF 54 /r	ANDPS <i>xmm1</i> , <i>xmm2/m128</i>	Valid	Valid	Bitwise logical AND of <i>xmm2/m128</i> and <i>xmm1</i> .

Description

Performs a bitwise logical AND of the four packed single-precision floating-point values from the source operand (second operand) and the destination operand (first operand), and stores the result in the destination operand.

The source operand can be an XMM register or a 128-bit memory location. The destination operand is an XMM register.

In 64-bit mode, using a REX prefix in the form of REX.R permits this instruction to access additional registers (XMM8-XMM15).

Operation

DEST[127:0] ← DEST[127:0] BitwiseAND SRC[127:0];

Intel C/C++ Compiler Intrinsic Equivalent

ANDPS `__m128 _mm_and_ps(__m128 a, __m128 b)`

SIMD Floating-Point Exceptions

None.

Protected Mode Exceptions

#GP(0)	For an illegal memory operand effective address in the CS, DS, ES, FS or GS segments. If a memory operand is not aligned on a 16-byte boundary, regardless of segment.
#SS(0)	For an illegal address in the SS segment.
#PF(fault-code)	For a page fault.
#NM	If CR0.TS[bit 3] = 1.
#UD	If CR0.EM[bit 2] = 1. If CR4.OSFXSR[bit 9] = 0. If CPUID.01H: EDX.SSE[bit 25] = 0. If the LOCK prefix is used.

Real-Address Mode Exceptions

#GP	If a memory operand is not aligned on a 16-byte boundary, regardless of segment. If any part of the operand lies outside the effective address space from 0 to FFFFH.
#NM	If CR0.TS[bit 3] = 1.
#UD	If CR0.EM[bit 2] = 1. If CR4.OSFXSR[bit 9] = 0. If CPUID.01H: EDX.SSE[bit 25] = 0. If the LOCK prefix is used.

Virtual-8086 Mode Exceptions

Same exceptions as in real address mode.

#PF(fault-code)	For a page fault.
-----------------	-------------------

Compatibility Mode Exceptions

Same exceptions as in protected mode.

64-Bit Mode Exceptions

#SS(0)	If a memory address referencing the SS segment is in a non-canonical form.
#GP(0)	If the memory address is in a non-canonical form. If memory operand is not aligned on a 16-byte boundary, regardless of segment.
#PF(fault-code)	For a page fault.
#NM	If CR0.TS[bit 3] = 1.
#UD	If CR0.EM[bit 2] = 1. If CR4.OSFXSR[bit 9] = 0. If CPUID.01H: EDX.SSE[bit 25] = 0. If the LOCK prefix is used.

ANDNPD—Bitwise Logical AND NOT of Packed Double-Precision Floating-Point Values

Opcode	Instruction	64-Bit Mode	Compat/Leg Mode	Description
66 0F 55 /r	ANDNPD <i>xmm1</i> , <i>xmm2/m128</i>	Valid	Valid	Bitwise logical AND NOT of <i>xmm2/m128</i> and <i>xmm1</i> .

Description

Inverts the bits of the two packed double-precision floating-point values in the destination operand (first operand), performs a bitwise logical AND of the two packed double-precision floating-point values in the source operand (second operand) and the temporary inverted result, and stores the result in the destination operand.

The source operand can be an XMM register or a 128-bit memory location. The destination operand is an XMM register.

In 64-bit mode, using a REX prefix in the form of REX.R permits this instruction to access additional registers (XMM8-XMM15).

Operation

$$\text{DEST}[127:0] \leftarrow (\text{NOT}(\text{DEST}[127:0])) \text{ BitwiseAND } (\text{SRC}[127:0]);$$

Intel C/C++ Compiler Intrinsic Equivalent

ANDNPD `__m128d _mm_andnot_pd(__m128d a, __m128d b)`

SIMD Floating-Point Exceptions

None.

Protected Mode Exceptions

#GP(0)	For an illegal memory operand effective address in the CS, DS, ES, FS or GS segments. If a memory operand is not aligned on a 16-byte boundary, regardless of segment.
#SS(0)	For an illegal address in the SS segment.
#PF(fault-code)	For a page fault.
#NM	If CR0.TS[bit 3] = 1.

#UD
 If CR0.EM[bit 2] = 1.
 If CR4.OSFXSR[bit 9] = 0.
 If CPUID.01H:EDX.SSE2[bit 26] = 0.
 If the LOCK prefix is used.

Real-Address Mode Exceptions

#GP
 If a memory operand is not aligned on a 16-byte boundary, regardless of segment.
 If any part of the operand lies outside the effective address space from 0 to FFFFH.

#NM
 If CR0.TS[bit 3] = 1.
 #UD
 If CR0.EM[bit 2] = 1.
 If CR4.OSFXSR[bit 9] = 0.
 If CPUID.01H:EDX.SSE2[bit 26] = 0.
 If the LOCK prefix is used.

Virtual-8086 Mode Exceptions

Same exceptions as in real address mode.

#PF(fault-code) For a page fault.

Compatibility Mode Exceptions

Same exceptions as in protected mode.

64-Bit Mode Exceptions

#SS(0) If a memory address referencing the SS segment is in a non-canonical form.
 #GP(0) If the memory address is in a non-canonical form.
 If memory operand is not aligned on a 16-byte boundary, regardless of segment.
 #PF(fault-code) For a page fault.
 #NM
 #UD
 If CR0.EM[bit 2] = 1.
 If CR4.OSFXSR[bit 9] = 0.
 If CPUID.01H:EDX.SSE2[bit 26] = 0.
 If the LOCK prefix is used.

ANDNPS—Bitwise Logical AND NOT of Packed Single-Precision Floating-Point Values

Opcode	Instruction	64-Bit Mode	Compat/Leg Mode	Description
OF 55 /r	ANDNPS <i>xmm1</i> , <i>xmm2/m128</i>	Valid	Valid	Bitwise logical AND NOT of <i>xmm2/m128</i> and <i>xmm1</i> .

Description

Inverts the bits of the four packed single-precision floating-point values in the destination operand (first operand), performs a bitwise logical AND of the four packed single-precision floating-point values in the source operand (second operand) and the temporary inverted result, and stores the result in the destination operand.

The source operand can be an XMM register or a 128-bit memory location. The destination operand is an XMM register.

In 64-bit mode, using a REX prefix in the form of REX.R permits this instruction to access additional registers (XMM8-XMM15).

Operation

DEST[127:0] ← (NOT(DEST[127:0])) BitwiseAND (SRC[127:0]);

Intel C/C++ Compiler Intrinsic Equivalent

ANDNPS `_mm128 _mm_andnot_ps(_mm128 a, _mm128 b)`

SIMD Floating-Point Exceptions

None.

Protected Mode Exceptions

#GP(0)	For an illegal memory operand effective address in the CS, DS, ES, FS or GS segments. If a memory operand is not aligned on a 16-byte boundary, regardless of segment.
#SS(0)	For an illegal address in the SS segment.
#PF(fault-code)	For a page fault.
#NM	If CR0.TS[bit 3] = 1.
#UD	If CR0.EM[bit 2] = 1. If CR4.OSFXSR[bit 9] = 0. If CPUID.01H: EDX.SSE[bit 25] = 0. If the LOCK prefix is used.

Real-Address Mode Exceptions

#GP	If a memory operand is not aligned on a 16-byte boundary, regardless of segment. If any part of the operand lies outside the effective address space from 0 to FFFFH.
#NM	If CR0.TS[bit 3] = 1.
#UD	If CR0.EM[bit 2] = 1. If CR4.OSFXSR[bit 9] = 0. If CPUID.01H: EDX.SSE[bit 25] = 0. If the LOCK prefix is used.

Virtual-8086 Mode Exceptions

Same exceptions as in real address mode.

#PF(fault-code)	For a page fault.
-----------------	-------------------

Compatibility Mode Exceptions

Same exceptions as in protected mode.

64-Bit Mode Exceptions

#SS(0)	If a memory address referencing the SS segment is in a non-canonical form.
#GP(0)	If the memory address is in a non-canonical form. If memory operand is not aligned on a 16-byte boundary, regardless of segment.
#PF(fault-code)	For a page fault.
#NM	If CR0.TS[bit 3] = 1.
#UD	If CR0.EM[bit 2] = 1. If CR4.OSFXSR[bit 9] = 0. If CPUID.01H: EDX.SSE[bit 25] = 0. If the LOCK prefix is used.

ARPL—Adjust RPL Field of Segment Selector

Opcode	Instruction	64-Bit Mode	Compat/Leg Mode	Description
63 /r	ARPL r/m16, r16	N. E.	Valid	Adjust RPL of r/m16 to not less than RPL of r16.

Description

Compares the RPL fields of two segment selectors. The first operand (the destination operand) contains one segment selector and the second operand (source operand) contains the other. (The RPL field is located in bits 0 and 1 of each operand.) If the RPL field of the destination operand is less than the RPL field of the source operand, the ZF flag is set and the RPL field of the destination operand is increased to match that of the source operand. Otherwise, the ZF flag is cleared and no change is made to the destination operand. (The destination operand can be a word register or a memory location; the source operand must be a word register.)

The ARPL instruction is provided for use by operating-system procedures (however, it can also be used by applications). It is generally used to adjust the RPL of a segment selector that has been passed to the operating system by an application program to match the privilege level of the application program. Here the segment selector passed to the operating system is placed in the destination operand and segment selector for the application program's code segment is placed in the source operand. (The RPL field in the source operand represents the privilege level of the application program.) Execution of the ARPL instruction then insures that the RPL of the segment selector received by the operating system is no lower (does not have a higher privilege) than the privilege level of the application program (the segment selector for the application program's code segment can be read from the stack following a procedure call).

This instruction executes as described in compatibility mode and legacy mode. It is not encodable in 64-bit mode.

See "Checking Caller Access Privileges" in Chapter 3, "Protected-Mode Memory Management," of the *Intel® 64 and IA-32 Architectures Software Developer's Manual, Volume 3A*, for more information about the use of this instruction.

Operation

```
IF 64-BIT MODE
  THEN
    See MOVSDX;
  ELSE
    IF DEST[RPL] < SRC[RPL]
      THEN
        ZF ← 1;
        DEST[RPL] ← SRC[RPL];
```

```

        ELSE
            ZF ← 0;
    FI;
FI;
```

Flags Affected

The ZF flag is set to 1 if the RPL field of the destination operand is less than that of the source operand; otherwise, it is set to 0.

Protected Mode Exceptions

#GP(0)	If the destination is located in a non-writable segment. If a memory operand effective address is outside the CS, DS, ES, FS, or GS segment limit. If the DS, ES, FS, or GS register is used to access memory and it contains a NULL segment selector.
#SS(0)	If a memory operand effective address is outside the SS segment limit.
#PF(fault-code)	If a page fault occurs.
#AC(0)	If alignment checking is enabled and an unaligned memory reference is made while the current privilege level is 3.
#UD	If the LOCK prefix is used.

Real-Address Mode Exceptions

#UD	The ARPL instruction is not recognized in real-address mode. If the LOCK prefix is used.
-----	---------------------------------------------------------------------------------------------

Virtual-8086 Mode Exceptions

#UD	The ARPL instruction is not recognized in virtual-8086 mode. If the LOCK prefix is used.
-----	---------------------------------------------------------------------------------------------

Compatibility Mode Exceptions

Same exceptions as in protected mode.

64-Bit Mode Exceptions

Not applicable.

BLENDPD — Blend Packed Double Precision Floating-Point Values

Opcode	Instruction	64-bit Mode	Compat/ Leg Mode	Description
66 OF 3A 0D /r ib	BLENDPD <i>xmm1</i> , <i>xmm2/m128</i> , <i>imm8</i>	Valid	Valid	Select packed DP-FP values from <i>xmm1</i> and <i>xmm2/m128</i> from mask specified in <i>imm8</i> and store the values into <i>xmm1</i> .

Description

Packed double-precision floating-point values from the source operand (second operand) are conditionally copied to the destination operand depending on the mask bits in the immediate operand. The mask bits are bits [1:0] of the immediate byte (third operand). Each mask bit corresponds to a quadword element in a 128-bit operand.

If a mask bit is "1", then the corresponding quadword in the source operand is copied to the destination, else the quadword element in the destination operand is left unchanged.

Operation

```
IF (imm8[0] == 1)
    THEN DEST[63:0] ← SRC[63:0];
    ELSE DEST[63:0] ← DEST[63:0]; FI;
IF (imm8[1] == 1)
    THEN DEST[127:64] ← SRC[127:64];
    ELSE DEST[127:64] ← DEST[127:64]; FI;
```

Intel C/C++ Compiler Intrinsic Equivalent

```
BLENDPD __m128d __mm_blend_pd (__m128d v1, __m128d v2, const int mask);
```

SIMD Floating-Point Exceptions

None

Protected Mode Exceptions

- #GP(0) For an illegal memory operand effective address in the CS, DS, ES, FS, or GS segments.
If a memory operand is not aligned on a 16-byte boundary, regardless of segment.
- #SS(0) For an illegal address in the SS segment.
- #PF(fault-code) For a page fault.

#NM If CR0.TS[bit 3] = 1.
 #UD If CR0.EM[bit 2] = 1.
 If CR4.OSFXSR[bit 9] = 0
 If CPUID.01H: ECX.SSE4_1[bit 19] = 0.
 If LOCK prefix is used.
 Either the prefix REP (F3h) or REPN (F2H) is used.

Real Mode Exceptions

#GP(0) If any part of the operand lies outside of the effective address space from 0 to 0FFFFH.
 If a memory operand is not aligned on a 16-byte boundary, regardless of segment.
 #NM If CR0.TS[bit 3] = 1.
 #UD If CR0.EM[bit 2] = 1.
 If CR4.OSFXSR[bit 9] = 0.
 If CPUID.01H: ECX.SSE4_1[bit 19] = 0.
 If LOCK prefix is used.
 Either the prefix REP (F3h) or REPN (F2H) is used.

Virtual 8086 Mode Exceptions

Same exceptions as in Real Address Mode.

#PF(fault-code) For a page fault.

Compatibility Mode Exceptions

Same exceptions as in Protected Mode.

64-Bit Mode Exceptions

#GP(0) If the memory address is in a non-canonical form.
 If a memory operand is not aligned on a 16-byte boundary, regardless of segment.
 #SS(0) If a memory address referencing the SS segment is in a non-canonical form.
 #PF(fault-code) For a page fault.
 #NM If TS in CR0 is set.
 #UD If EM in CR0 is set.
 If OSFXSR in CR4 is 0.
 If CPUID feature flag ECX.SSE4_1 is 0.
 If LOCK prefix is used.
 Either the prefix REP (F3h) or REPN (F2H) is used.

BLENDPS — Blend Packed Single Precision Floating-Point Values

Opcode	Instruction	64-bit Mode	Compat/ Leg Mode	Description
66 OF 3A 0C <i>/r ib</i>	BLENDPS <i>xmm1</i> , <i>xmm2/m128</i> , <i>imm8</i>	Valid	Valid	Select packed single precision floating-point values from <i>xmm1</i> and <i>xmm2/m128</i> from mask specified in <i>imm8</i> and store the values into <i>xmm1</i> .

Description

Packed single-precision floating-point values from the source operand (second operand) are conditionally copied to the destination operand (first operand) depending on the mask bits in the immediate operand. The mask bits are bits [3:0] of the immediate byte (third operand). Each mask bit corresponds to a dword element in a 128-bit operand.

If a mask bit is "1", then the corresponding dword in the source operand is copied to the destination, else the dword element in the destination operand is left unchanged.

Operation

```
IF (imm8[0] == 1)
    THEN DEST[31:0] ← SRC[31:0];
    ELSE DEST[31:0] ← DEST[31:0]; FI;
IF (imm8[1] == 1)
    THEN DEST[63:32] ← SRC[63:32];
    ELSE DEST[63:32] ← DEST[63:32]; FI;
IF (imm8[2] == 1)
    THEN DEST[95:64] ← SRC[95:64];
    ELSE DEST[95:64] ← DEST[95:64]; FI;
IF (imm8[3] == 1)
    THEN DEST[127:96] ← SRC[127:96];
    ELSE DEST[127:96] ← DEST[127:96]; FI;
```

Intel C/C++ Compiler Intrinsic Equivalent

```
BLENDPS    __m128 _mm_blend_ps (__m128 v1, __m128 v2, const int mask);
```

SIMD Floating-Point Exceptions

None

Protected Mode Exceptions

#GP(0)	For an illegal memory operand effective address in the CS, DS, ES, FS, or GS segments. If a memory operand is not aligned on a 16-byte boundary, regardless of segment.
#SS(0)	For an illegal address in the SS segment.
#PF(fault-code)	For a page fault.
#NM	If CR0.TS[bit 3] = 1.
#UD	If CR0.EM[bit 2] = 1. If CR4.OSFXSR[bit 9] = 0. If CPUID.01H: ECX.SSE4_1[bit 19] = 0. If LOCK prefix is used. Either the prefix REP (F3h) or REPN (F2H) is used.

Real Mode Exceptions

#GP(0)	if any part of the operand lies outside of the effective address space from 0 to 0FFFFH. If not aligned on 16-byte boundary, regardless of segment
#NM	If CR0.TS[bit 3] = 1.
#UD	If CR0.EM[bit 2] = 1. If CR4.OSFXSR[bit 9] = 0 If CPUID.01H: ECX.SSE4_1[bit 19] = 0. If LOCK prefix is used. Either the prefix REP (F3h) or REPN (F2H) is used.

Virtual 8086 Mode Exceptions

Same exceptions as in Real Address Mode.

#PF(fault-code)	For a page fault.
-----------------	-------------------

Compatibility Mode Exceptions

Same exceptions as in Protected Mode.

64-Bit Mode Exceptions

#GP(0)	If the memory address is in a non-canonical form. If not aligned on 16-byte boundary, regardless of segment
#SS(0)	If a memory address referencing the SS segment is in a non-canonical form.
#PF(fault-code)	For a page fault.
#NM	If TS in CR0 is set.

#UD

If EM in CR0 is set.

If OSFXSR in CR4 is 0.

If CPUID feature flag ECX.SSE4_1 is 0.

If LOCK prefix is used.

Either the prefix REP (F3h) or REPN (F2H) is used.

BLENDVPD — Variable Blend Packed Double Precision Floating-Point Values

Opcode	Instruction	64-bit Mode	Compat/ Leg Mode	Description
66 OF 38 15 /r	BLENDVPD <i>xmm1</i> , <i>xmm2/m128</i> , < <i>XMM0</i> >	Valid	Valid	Select packed DP FP values from <i>xmm1</i> and <i>xmm2</i> from mask specified in <i>XMM0</i> and store the values in <i>xmm1</i> .

Description

Packed double-precision floating-point values from the source operand (second argument) are conditionally copied to the destination operand (first argument) depending on the mask bits in the implicit third register argument, *XMM0*. The mask bits are the most significant bit in each qword element of *XMM0*. Each mask bit corresponds to a quadword element in a 128-bit operand.

If a mask bit is "1", then the corresponding quadword element in the source operand is copied to the destination, else the quadword element in the destination operand is left unchanged.

The register assignment of the third operand is defined to be the architectural register *XMM0*.

Operation

```
MASK ← XMM0;
IF (MASK[63] == 1)
    THEN DEST[63:0] ← SRC[63:0];
    ELSE DEST[63:0] ← DEST[63:0]; FI;
IF (MASK[127] == 1)
    THEN DEST[127:64] ← SRC[127:64];
    ELSE DEST[127:64] ← DEST[127:64]; FI;
```

Intel C/C++ Compiler Intrinsic Equivalent

```
BLENDVPD    __m128d _mm_blendv_pd(__m128d v1, __m128d v2, __m128d v3);
```

SIMD Floating-Point Exceptions

None

Protected Mode Exceptions

#GP(0)	For an illegal memory operand effective address in the CS, DS, ES, FS, or GS segments. If a memory operand is not aligned on a 16-byte boundary, regardless of segment.
#SS(0)	For an illegal address in the SS segment.
#PF(fault-code)	For a page fault.
#NM	If CR0.TS[bit 3] = 1.
#UD	If CR0.EM[bit 2] = 1. If CR4.OSFXSR[bit 9] = 0. If CPUID.01H:ECX.SSE4_1[bit 19] = 0. If LOCK prefix is used. Either the prefix REP (F3h) or REPN (F2H) is used.

Real Mode Exceptions

#GP(0)	if any part of the operand lies outside of the effective address space from 0 to 0FFFFH. If a memory operand is not aligned on a 16-byte boundary, regardless of segment.
#NM	If CR0.TS[bit 3] = 1.
#UD	If CR0.EM[bit 2] = 1. If CR4.OSFXSR[bit 9] = 0. If CPUID.01H:ECX.SSE4_1[bit 19] = 0. If LOCK prefix is used. Either the prefix REP (F3h) or REPN (F2H) is used.

Virtual 8086 Mode Exceptions

Same exceptions as in Real Address Mode.

#PF(fault-code)	For a page fault.
-----------------	-------------------

Compatibility Mode Exceptions

Same exceptions as in Protected Mode.

64-Bit Mode Exceptions

#GP(0)	If the memory address is in a non-canonical form. If a memory operand is not aligned on a 16-byte boundary, regardless of segment.
#SS(0)	If a memory address referencing the SS segment is in a non-canonical form.

INSTRUCTION SET REFERENCE, A-M

#PF(fault-code)	For a page fault.
#NM	If TS in CR0 is set.
#UD	If EM in CR0 is set. If OSFXSR in CR4 is 0. If CPUID feature flag ECX.SSE4_1 is 0. If LOCK prefix is used. Either the prefix REP (F3h) or REPN (F2H) is used.

BLENDVPS – Variable Blend Packed Single Precision Floating-Point Values

Opcode	Instruction	64-bit Mode	Compat/ Leg Mode	Description
66 OF 38 14 /r	BLENDVPS <i>xmm1</i> , <i>xmm2/m128</i> , <XMM0>	Valid	Valid	Select packed single precision floating-point values from <i>xmm1</i> and <i>xmm2/m128</i> from mask specified in XMM0 and store the values into <i>xmm1</i> .

Description

Packed single-precision floating-point values from the source operand (second argument) are conditionally written to the destination operand (first argument) depending on the mask bits in the third register argument. The mask bits are the most significant bit in each dword element of XMM0. Each mask bit corresponds to a dword element in a 128-bit operand.

If a mask bit is "1", then the corresponding dword element in the source operand is copied to the destination, else the dword element in the destination operand is left unchanged.

The register assignment of the third operand is defined to be the architectural register XMM0.

Operation

```
MASK ← XMM0;
IF (MASK[31] == 1)
    THEN DEST[31:0] ← SRC[31:0];
    ELSE DEST[31:0] ← DEST[31:0]; FI;
IF (MASK[63] == 1)
    THEN DEST[63:32] ← SRC[63:32];
    ELSE DEST[63:32] ← DEST[63:32]; FI;
IF (MASK[95] == 1)
    THEN DEST[95:64] ← SRC[95:64];
    ELSE DEST[95:64] ← DEST[95:64]; FI;
IF (MASK[127] == 1)
    THEN DEST[127:96] ← SRC[127:96];
    ELSE DEST[127:96] ← DEST[127:96]; FI;
```

Intel C/C++ Compiler Intrinsic Equivalent

BLENDVPS `__m128 _mm_blendv_ps(__m128 v1, __m128 v2, __m128 v3);`

SIMD Floating-Point Exceptions

None

Protected Mode Exceptions

#GP(0)	For an illegal memory operand effective address in the CS, DS, ES, FS, or GS segments. If a memory operand is not aligned on a 16-byte boundary, regardless of segment.
#SS(0)	For an illegal address in the SS segment.
#PF(fault-code)	For a page fault.
#NM	If CR0.TS[bit 3] = 1.
#UD	If CR0.EM[bit 2] = 1. If CR4.OSFXSR[bit 9] = 0. If CPUID.01H: ECX.SSE4_1[bit 19] = 0. If LOCK prefix is used. Either the prefix REP (F3h) or REPN (F2H) is used.

Real Mode Exceptions

#GP(0)	if any part of the operand lies outside of the effective address space from 0 to 0FFFFH. If a memory operand is not aligned on a 16-byte boundary, regardless of segment.
#NM	If CR0.TS[bit 3] = 1.
#UD	If CR0.EM[bit 2] = 1. If CR4.OSFXSR[bit 9] = 0. If CPUID.01H: ECX.SSE4_1[bit 19] = 0. If LOCK prefix is used. Either the prefix REP (F3h) or REPN (F2H) is used.

Virtual 8086 Mode Exceptions

Same exceptions as in Real Address Mode.

#PF(fault-code)	For a page fault.
-----------------	-------------------

Compatibility Mode Exceptions

Same exceptions as in Protected Mode.

64-Bit Mode Exceptions

#GP(0)	If the memory address is in a non-canonical form. If a memory operand is not aligned on a 16-byte boundary, regardless of segment.
#SS(0)	If a memory address referencing the SS segment is in a non-canonical form.
#PF(fault-code)	For a page fault.
#NM	If TS in CR0 is set.
#UD	If EM in CR0 is set. If OSFXSR in CR4 is 0. If CPUID feature flag ECX.SSE4_1 is 0. If LOCK prefix is used. Either the prefix REP (F3h) or REPN (F2H) is used.

BOUND—Check Array Index Against Bounds

Opcode	Instruction	64-Bit Mode	Compat/ Leg Mode	Description
62 /r	BOUND <i>r16, m16&16</i>	Invalid	Valid	Check if <i>r16</i> (array index) is within bounds specified by <i>m16&16</i> .
62 /r	BOUND <i>r32, m32&32</i>	Invalid	Valid	Check if <i>r32</i> (array index) is within bounds specified by <i>m16&16</i> .

Description

BOUND determines if the first operand (array index) is within the bounds of an array specified the second operand (bounds operand). The array index is a signed integer located in a register. The bounds operand is a memory location that contains a pair of signed doubleword-integers (when the operand-size attribute is 32) or a pair of signed word-integers (when the operand-size attribute is 16). The first doubleword (or word) is the lower bound of the array and the second doubleword (or word) is the upper bound of the array. The array index must be greater than or equal to the lower bound and less than or equal to the upper bound plus the operand size in bytes. If the index is not within bounds, a BOUND range exceeded exception (#BR) is signaled. When this exception is generated, the saved return instruction pointer points to the BOUND instruction.

The bounds limit data structure (two words or doublewords containing the lower and upper limits of the array) is usually placed just before the array itself, making the limits addressable via a constant offset from the beginning of the array. Because the address of the array already will be present in a register, this practice avoids extra bus cycles to obtain the effective address of the array bounds.

This instruction executes as described in compatibility mode and legacy mode. It is not valid in 64-bit mode.

Operation

```

IF 64bit Mode
  THEN
    #UD;
  ELSE
    IF (ArrayIndex < LowerBound OR ArrayIndex > UpperBound)
      (* Below lower bound or above upper bound *)
      THEN #BR; FI;
FI;

```

Flags Affected

None.

Protected Mode Exceptions

#BR	If the bounds test fails.
#UD	If second operand is not a memory location. If the LOCK prefix is used.
#GP(0)	If a memory operand effective address is outside the CS, DS, ES, FS, or GS segment limit. If the DS, ES, FS, or GS register contains a NULL segment selector.
#SS(0)	If a memory operand effective address is outside the SS segment limit.
#PF(fault-code)	If a page fault occurs.
#AC(0)	If alignment checking is enabled and an unaligned memory reference is made while the current privilege level is 3.

Real-Address Mode Exceptions

#BR	If the bounds test fails.
#UD	If second operand is not a memory location. If the LOCK prefix is used.
#GP	If a memory operand effective address is outside the CS, DS, ES, FS, or GS segment limit.
#SS	If a memory operand effective address is outside the SS segment limit.

Virtual-8086 Mode Exceptions

#BR	If the bounds test fails.
#UD	If second operand is not a memory location. If the LOCK prefix is used.
#GP(0)	If a memory operand effective address is outside the CS, DS, ES, FS, or GS segment limit.
#SS(0)	If a memory operand effective address is outside the SS segment limit.
#PF(fault-code)	If a page fault occurs.
#AC(0)	If alignment checking is enabled and an unaligned memory reference is made.

Compatibility Mode Exceptions

Same exceptions as in protected mode.

64-Bit Mode Exceptions

#UD If in 64-bit mode.

BSF—Bit Scan Forward

Opcode	Instruction	64-Bit Mode	Compat/ Leg Mode	Description
OF BC /r	BSF <i>r16, r/m16</i>	Valid	Valid	Bit scan forward on <i>r/m16</i> .
OF BC /r	BSF <i>r32, r/m32</i>	Valid	Valid	Bit scan forward on <i>r/m32</i> .
REX.W + OF BC	BSF <i>r64, r/m64</i>	Valid	N.E.	Bit scan forward on <i>r/m64</i> .

Description

Searches the source operand (second operand) for the least significant set bit (1 bit). If a least significant 1 bit is found, its bit index is stored in the destination operand (first operand). The source operand can be a register or a memory location; the destination operand is a register. The bit index is an unsigned offset from bit 0 of the source operand. If the content of the source operand is 0, the content of the destination operand is undefined.

In 64-bit mode, the instruction's default operation size is 32 bits. Using a REX prefix in the form of REX.R permits access to additional registers (R8-R15). Using a REX prefix in the form of REX.W promotes operation to 64 bits. See the summary chart at the beginning of this section for encoding data and limits.

Operation

```

IF SRC = 0
  THEN
    ZF ← 1;
    DEST is undefined;
  ELSE
    ZF ← 0;
    temp ← 0;
    WHILE Bit(SRC, temp) = 0
    DO
      temp ← temp + 1;
      DEST ← temp;
    OD;
FI;

```

Flags Affected

The ZF flag is set to 1 if all the source operand is 0; otherwise, the ZF flag is cleared. The CF, OF, SF, AF, and PF, flags are undefined.

Protected Mode Exceptions

#GP(0)	If a memory operand effective address is outside the CS, DS, ES, FS, or GS segment limit. If the DS, ES, FS, or GS register contains a NULL segment selector.
#SS(0)	If a memory operand effective address is outside the SS segment limit.
#PF(fault-code)	If a page fault occurs.
#AC(0)	If alignment checking is enabled and an unaligned memory reference is made while the current privilege level is 3.
#UD	If the LOCK prefix is used.

Real-Address Mode Exceptions

#GP	If a memory operand effective address is outside the CS, DS, ES, FS, or GS segment limit.
#SS	If a memory operand effective address is outside the SS segment limit.
#UD	If the LOCK prefix is used.

Virtual-8086 Mode Exceptions

#GP(0)	If a memory operand effective address is outside the CS, DS, ES, FS, or GS segment limit.
#SS(0)	If a memory operand effective address is outside the SS segment limit.
#PF(fault-code)	If a page fault occurs.
#AC(0)	If alignment checking is enabled and an unaligned memory reference is made.
#UD	If the LOCK prefix is used.

Compatibility Mode Exceptions

Same exceptions as in protected mode.

64-Bit Mode Exceptions

#SS(0)	If a memory address referencing the SS segment is in a non-canonical form.
#GP(0)	If the memory address is in a non-canonical form.
#PF(fault-code)	If a page fault occurs.
#AC(0)	If alignment checking is enabled and an unaligned memory reference is made while the current privilege level is 3.
#UD	If the LOCK prefix is used.

BSR—Bit Scan Reverse

Opcode	Instruction	64-Bit Mode	Compat/ Leg Mode	Description
OF BD /r	BSR <i>r16, r/m16</i>	Valid	Valid	Bit scan reverse on <i>r/m16</i> .
OF BD /r	BSR <i>r32, r/m32</i>	Valid	Valid	Bit scan reverse on <i>r/m32</i> .
REX.W + OF BD	BSR <i>r64, r/m64</i>	Valid	N.E.	Bit scan reverse on <i>r/m64</i> .

Description

Searches the source operand (second operand) for the most significant set bit (1 bit). If a most significant 1 bit is found, its bit index is stored in the destination operand (first operand). The source operand can be a register or a memory location; the destination operand is a register. The bit index is an unsigned offset from bit 0 of the source operand. If the content source operand is 0, the content of the destination operand is undefined.

In 64-bit mode, the instruction's default operation size is 32 bits. Using a REX prefix in the form of REX.R permits access to additional registers (R8-R15). Using a REX prefix in the form of REX.W promotes operation to 64 bits. See the summary chart at the beginning of this section for encoding data and limits.

Operation

```

IF SRC = 0
  THEN
    ZF ← 1;
    DEST is undefined;
  ELSE
    ZF ← 0;
    temp ← OperandSize - 1;
    WHILE Bit(SRC, temp) = 0
    DO
      temp ← temp - 1;
      DEST ← temp;
    OD;
FI;

```

Flags Affected

The ZF flag is set to 1 if all the source operand is 0; otherwise, the ZF flag is cleared. The CF, OF, SF, AF, and PF, flags are undefined.

Protected Mode Exceptions

#GP(0)	If a memory operand effective address is outside the CS, DS, ES, FS, or GS segment limit. If the DS, ES, FS, or GS register contains a NULL segment selector.
#SS(0)	If a memory operand effective address is outside the SS segment limit.
#PF(fault-code)	If a page fault occurs.
#AC(0)	If alignment checking is enabled and an unaligned memory reference is made while the current privilege level is 3.
#UD	If the LOCK prefix is used.

Real-Address Mode Exceptions

#GP	If a memory operand effective address is outside the CS, DS, ES, FS, or GS segment limit.
#SS	If a memory operand effective address is outside the SS segment limit.
#UD	If the LOCK prefix is used.

Virtual-8086 Mode Exceptions

#GP(0)	If a memory operand effective address is outside the CS, DS, ES, FS, or GS segment limit.
#SS(0)	If a memory operand effective address is outside the SS segment limit.
#PF(fault-code)	If a page fault occurs.
#AC(0)	If alignment checking is enabled and an unaligned memory reference is made.
#UD	If the LOCK prefix is used.

Compatibility Mode Exceptions

Same exceptions as in protected mode.

64-Bit Mode Exceptions

#SS(0)	If a memory address referencing the SS segment is in a non-canonical form.
#GP(0)	If the memory address is in a non-canonical form.
#PF(fault-code)	If a page fault occurs.
#AC(0)	If alignment checking is enabled and an unaligned memory reference is made while the current privilege level is 3.
#UD	If the LOCK prefix is used.

BSWAP—Byte Swap

Opcode	Instruction	64-Bit Mode	Compat/ Leg Mode	Description
OF C8+ <i>rd</i>	BSWAP <i>r32</i>	Valid*	Valid	Reverses the byte order of a 32-bit register.
REX.W + OF C8+ <i>rd</i>	BSWAP <i>r64</i>	Valid	N.E.	Reverses the byte order of a 64-bit register.

NOTES:

* See IA-32 Architecture Compatibility section below.

Description

Reverses the byte order of a 32-bit or 64-bit (destination) register. This instruction is provided for converting little-endian values to big-endian format and vice versa. To swap bytes in a word value (16-bit register), use the XCHG instruction. When the BSWAP instruction references a 16-bit register, the result is undefined.

In 64-bit mode, the instruction's default operation size is 32 bits. Using a REX prefix in the form of REX.R permits access to additional registers (R8-R15). Using a REX prefix in the form of REX.W promotes operation to 64 bits. See the summary chart at the beginning of this section for encoding data and limits.

IA-32 Architecture Legacy Compatibility

The BSWAP instruction is not supported on IA-32 processors earlier than the Intel486™ processor family. For compatibility with this instruction, software should include functionally equivalent code for execution on Intel processors earlier than the Intel486 processor family.

Operation

TEMP ← DEST

IF 64-bit mode AND OperandSize = 64

THEN

DEST[7:0] ← TEMP[63:56];
 DEST[15:8] ← TEMP[55:48];
 DEST[23:16] ← TEMP[47:40];
 DEST[31:24] ← TEMP[39:32];
 DEST[39:32] ← TEMP[31:24];
 DEST[47:40] ← TEMP[23:16];
 DEST[55:48] ← TEMP[15:8];
 DEST[63:56] ← TEMP[7:0];

ELSE

DEST[7:0] ← TEMP[31:24];

INSTRUCTION SET REFERENCE, A-M

DEST[15:8] ← TEMP[23:16];
DEST[23:16] ← TEMP[15:8];
DEST[31:24] ← TEMP[7:0];

FI;

Flags Affected

None.

Exceptions (All Operating Modes)

#UD If the LOCK prefix is used.

BT—Bit Test

Opcode	Instruction	64-Bit Mode	Compat/Leg Mode	Description
OF A3	BT <i>r/m16, r16</i>	Valid	Valid	Store selected bit in CF flag.
OF A3	BT <i>r/m32, r32</i>	Valid	Valid	Store selected bit in CF flag.
REX.W + OF A3	BT <i>r/m64, r64</i>	Valid	N.E.	Store selected bit in CF flag.
OF BA /4 <i>ib</i>	BT <i>r/m16, imm8</i>	Valid	Valid	Store selected bit in CF flag.
OF BA /4 <i>ib</i>	BT <i>r/m32, imm8</i>	Valid	Valid	Store selected bit in CF flag.
REX.W + OF BA /4 <i>ib</i>	BT <i>r/m64, imm8</i>	Valid	N.E.	Store selected bit in CF flag.

Description

Selects the bit in a bit string (specified with the first operand, called the bit base) at the bit-position designated by the bit offset (specified by the second operand) and stores the value of the bit in the CF flag. The bit base operand can be a register or a memory location; the bit offset operand can be a register or an immediate value:

- If the bit base operand specifies a register, the instruction takes the modulo 16, 32, or 64 of the bit offset operand (modulo size depends on the mode and register size; 64-bit operands are available only in 64-bit mode).
- If the bit base operand specifies a memory location, the operand represents the address of the byte in memory that contains the bit base (bit 0 of the specified byte) of the bit string. The range of the bit position that can be referenced by the offset operand depends on the operand size.

See also: **Bit(BitBase, BitOffset)** on page 3-10.

Some assemblers support immediate bit offsets larger than 31 by using the immediate bit offset field in combination with the displacement field of the memory operand. In this case, the low-order 3 or 5 bits (3 for 16-bit operands, 5 for 32-bit operands) of the immediate bit offset are stored in the immediate bit offset field, and the high-order bits are shifted and combined with the byte displacement in the addressing mode by the assembler. The processor will ignore the high order bits if they are not zero.

When accessing a bit in memory, the processor may access 4 bytes starting from the memory address for a 32-bit operand size, using by the following relationship:

$$\text{Effective Address} + (4 * (\text{BitOffset DIV } 32))$$

Or, it may access 2 bytes starting from the memory address for a 16-bit operand, using this relationship:

$$\text{Effective Address} + (2 * (\text{BitOffset} \text{ DIV } 16))$$

It may do so even when only a single byte needs to be accessed to reach the given bit. When using this bit addressing mechanism, software should avoid referencing areas of memory close to address space holes. In particular, it should avoid references to memory-mapped I/O registers. Instead, software should use the MOV instructions to load from or store to these addresses, and use the register form of these instructions to manipulate the data.

In 64-bit mode, the instruction's default operation size is 32 bits. Using a REX prefix in the form of REX.R permits access to additional registers (R8-R15). Using a REX prefix in the form of REX.W promotes operation to 64 bit operands. See the summary chart at the beginning of this section for encoding data and limits.

Operation

CF ← Bit(BitBase, BitOffset);

Flags Affected

The CF flag contains the value of the selected bit. The OF, SF, ZF, AF, and PF flags are undefined.

Protected Mode Exceptions

#GP(0)	If a memory operand effective address is outside the CS, DS, ES, FS, or GS segment limit. If the DS, ES, FS, or GS register contains a NULL segment selector.
#SS(0)	If a memory operand effective address is outside the SS segment limit.
#PF(fault-code)	If a page fault occurs.
#AC(0)	If alignment checking is enabled and an unaligned memory reference is made while the current privilege level is 3.
#UD	If the LOCK prefix is used.

Real-Address Mode Exceptions

#GP	If a memory operand effective address is outside the CS, DS, ES, FS, or GS segment limit.
#SS	If a memory operand effective address is outside the SS segment limit.
#UD	If the LOCK prefix is used.

Virtual-8086 Mode Exceptions

#GP(0)	If a memory operand effective address is outside the CS, DS, ES, FS, or GS segment limit.
#SS(0)	If a memory operand effective address is outside the SS segment limit.
#PF(fault-code)	If a page fault occurs.
#AC(0)	If alignment checking is enabled and an unaligned memory reference is made.
#UD	If the LOCK prefix is used.

Compatibility Mode Exceptions

Same exceptions as in protected mode.

64-Bit Mode Exceptions

#SS(0)	If a memory address referencing the SS segment is in a non-canonical form.
#GP(0)	If the memory address is in a non-canonical form.
#PF(fault-code)	If a page fault occurs.
#AC(0)	If alignment checking is enabled and an unaligned memory reference is made while the current privilege level is 3.
#UD	If the LOCK prefix is used.

BTC—Bit Test and Complement

Opcode	Instruction	64-Bit Mode	Compat/Leg Mode	Description
OF BB	BTC <i>r/m16, r16</i>	Valid	Valid	Store selected bit in CF flag and complement.
OF BB	BTC <i>r/m32, r32</i>	Valid	Valid	Store selected bit in CF flag and complement.
REX.W + OF BB	BTC <i>r/m64, r64</i>	Valid	N.E.	Store selected bit in CF flag and complement.
OF BA /7 <i>ib</i>	BTC <i>r/m16, imm8</i>	Valid	Valid	Store selected bit in CF flag and complement.
OF BA /7 <i>ib</i>	BTC <i>r/m32, imm8</i>	Valid	Valid	Store selected bit in CF flag and complement.
REX.W + OF BA /7 <i>ib</i>	BTC <i>r/m64, imm8</i>	Valid	N.E.	Store selected bit in CF flag and complement.

Description

Selects the bit in a bit string (specified with the first operand, called the bit base) at the bit-position designated by the bit offset operand (second operand), stores the value of the bit in the CF flag, and complements the selected bit in the bit string. The bit base operand can be a register or a memory location; the bit offset operand can be a register or an immediate value:

- If the bit base operand specifies a register, the instruction takes the modulo 16, 32, or 64 of the bit offset operand (modulo size depends on the mode and register size; 64-bit operands are available only in 64-bit mode). This allows any bit position to be selected.
- If the bit base operand specifies a memory location, the operand represents the address of the byte in memory that contains the bit base (bit 0 of the specified byte) of the bit string. The range of the bit position that can be referenced by the offset operand depends on the operand size.

See also: **Bit(BitBase, BitOffset)** on page 3-10.

Some assemblers support immediate bit offsets larger than 31 by using the immediate bit offset field in combination with the displacement field of the memory operand. See “BT—Bit Test” in this chapter for more information on this addressing mechanism.

This instruction can be used with a LOCK prefix to allow the instruction to be executed atomically.

In 64-bit mode, the instruction’s default operation size is 32 bits. Using a REX prefix in the form of REX.R permits access to additional registers (R8-R15). Using a REX

prefix in the form of REX.W promotes operation to 64 bits. See the summary chart at the beginning of this section for encoding data and limits.

Operation

CF ← Bit(BitBase, BitOffset);

Bit(BitBase, BitOffset) ← NOT Bit(BitBase, BitOffset);

Flags Affected

The CF flag contains the value of the selected bit before it is complemented. The OF, SF, ZF, AF, and PF flags are undefined.

Protected Mode Exceptions

#GP(0)	If the destination operand points to a non-writable segment. If a memory operand effective address is outside the CS, DS, ES, FS, or GS segment limit. If the DS, ES, FS, or GS register contains a NULL segment selector.
#SS(0)	If a memory operand effective address is outside the SS segment limit.
#PF(fault-code)	If a page fault occurs.
#AC(0)	If alignment checking is enabled and an unaligned memory reference is made while the current privilege level is 3.
#UD	If the LOCK prefix is used but the destination is not a memory operand.

Real-Address Mode Exceptions

#GP	If a memory operand effective address is outside the CS, DS, ES, FS, or GS segment limit.
#SS	If a memory operand effective address is outside the SS segment limit.
#UD	If the LOCK prefix is used but the destination is not a memory operand.

Virtual-8086 Mode Exceptions

#GP(0)	If a memory operand effective address is outside the CS, DS, ES, FS, or GS segment limit.
#SS(0)	If a memory operand effective address is outside the SS segment limit.
#PF(fault-code)	If a page fault occurs.

#AC(0)	If alignment checking is enabled and an unaligned memory reference is made.
#UD	If the LOCK prefix is used but the destination is not a memory operand.

Compatibility Mode Exceptions

Same exceptions as in protected mode.

64-Bit Mode Exceptions

#SS(0)	If a memory address referencing the SS segment is in a non-canonical form.
#GP(0)	If the memory address is in a non-canonical form.
#PF(fault-code)	If a page fault occurs.
#AC(0)	If alignment checking is enabled and an unaligned memory reference is made while the current privilege level is 3.
#UD	If the LOCK prefix is used but the destination is not a memory operand.

BTR—Bit Test and Reset

Opcode	Instruction	64-Bit Mode	Compat/Leg Mode	Description
OF B3	BTR <i>r/m16, r16</i>	Valid	Valid	Store selected bit in CF flag and clear.
OF B3	BTR <i>r/m32, r32</i>	Valid	Valid	Store selected bit in CF flag and clear.
REX.W + OF B3	BTR <i>r/m64, r64</i>	Valid	N.E.	Store selected bit in CF flag and clear.
OF BA /6 <i>ib</i>	BTR <i>r/m16, imm8</i>	Valid	Valid	Store selected bit in CF flag and clear.
OF BA /6 <i>ib</i>	BTR <i>r/m32, imm8</i>	Valid	Valid	Store selected bit in CF flag and clear.
REX.W + OF BA /6 <i>ib</i>	BTR <i>r/m64, imm8</i>	Valid	N.E.	Store selected bit in CF flag and clear.

DESCRIPTION

Selects the bit in a bit string (specified with the first operand, called the bit base) at the bit-position designated by the bit offset operand (second operand), stores the value of the bit in the CF flag, and clears the selected bit in the bit string to 0. The bit base operand can be a register or a memory location; the bit offset operand can be a register or an immediate value:

- If the bit base operand specifies a register, the instruction takes the modulo 16, 32, or 64 of the bit offset operand (modulo size depends on the mode and register size; 64-bit operands are available only in 64-bit mode). This allows any bit position to be selected.
- If the bit base operand specifies a memory location, the operand represents the address of the byte in memory that contains the bit base (bit 0 of the specified byte) of the bit string. The range of the bit position that can be referenced by the offset operand depends on the operand size.

See also: **Bit(BitBase, BitOffset)** on page 3-10.

Some assemblers support immediate bit offsets larger than 31 by using the immediate bit offset field in combination with the displacement field of the memory operand. See “BT—Bit Test” in this chapter for more information on this addressing mechanism.

This instruction can be used with a LOCK prefix to allow the instruction to be executed atomically.

In 64-bit mode, the instruction’s default operation size is 32 bits. Using a REX prefix in the form of REX.R permits access to additional registers (R8-R15). Using a REX

prefix in the form of REX.W promotes operation to 64 bits. See the summary chart at the beginning of this section for encoding data and limits.

Operation

CF ← Bit(BitBase, BitOffset);
Bit(BitBase, BitOffset) ← 0;

Flags Affected

The CF flag contains the value of the selected bit before it is cleared. The OF, SF, ZF, AF, and PF flags are undefined.

Protected Mode Exceptions

#GP(0)	If the destination operand points to a non-writable segment. If a memory operand effective address is outside the CS, DS, ES, FS, or GS segment limit. If the DS, ES, FS, or GS register contains a NULL segment selector.
#SS(0)	If a memory operand effective address is outside the SS segment limit.
#PF(fault-code)	If a page fault occurs.
#AC(0)	If alignment checking is enabled and an unaligned memory reference is made while the current privilege level is 3.
#UD	If the LOCK prefix is used but the destination is not a memory operand.

Real-Address Mode Exceptions

#GP	If a memory operand effective address is outside the CS, DS, ES, FS, or GS segment limit.
#SS	If a memory operand effective address is outside the SS segment limit.
#UD	If the LOCK prefix is used but the destination is not a memory operand.

Virtual-8086 Mode Exceptions

#GP(0)	If a memory operand effective address is outside the CS, DS, ES, FS, or GS segment limit.
#SS(0)	If a memory operand effective address is outside the SS segment limit.
#PF(fault-code)	If a page fault occurs.

#AC(0)	If alignment checking is enabled and an unaligned memory reference is made.
#UD	If the LOCK prefix is used but the destination is not a memory operand.

Compatibility Mode Exceptions

Same exceptions as in protected mode.

64-Bit Mode Exceptions

#SS(0)	If a memory address referencing the SS segment is in a non-canonical form.
#GP(0)	If the memory address is in a non-canonical form.
#PF(fault-code)	If a page fault occurs.
#AC(0)	If alignment checking is enabled and an unaligned memory reference is made while the current privilege level is 3.
#UD	If the LOCK prefix is used but the destination is not a memory operand.

BTS—Bit Test and Set

Opcode	Instruction	64-Bit Mode	Compat/Leg Mode	Description
OF AB	BTS <i>r/m16, r16</i>	Valid	Valid	Store selected bit in CF flag and set.
OF AB	BTS <i>r/m32, r32</i>	Valid	Valid	Store selected bit in CF flag and set.
REX.W + OF AB	BTS <i>r/m64, r64</i>	Valid	N.E.	Store selected bit in CF flag and set.
OF BA /5 <i>ib</i>	BTS <i>r/m16, imm8</i>	Valid	Valid	Store selected bit in CF flag and set.
OF BA /5 <i>ib</i>	BTS <i>r/m32, imm8</i>	Valid	Valid	Store selected bit in CF flag and set.
REX.W + OF BA /5 <i>ib</i>	BTS <i>r/m64, imm8</i>	Valid	N.E.	Store selected bit in CF flag and set.

Description

Selects the bit in a bit string (specified with the first operand, called the bit base) at the bit-position designated by the bit offset operand (second operand), stores the value of the bit in the CF flag, and sets the selected bit in the bit string to 1. The bit base operand can be a register or a memory location; the bit offset operand can be a register or an immediate value:

- If the bit base operand specifies a register, the instruction takes the modulo 16, 32, or 64 of the bit offset operand (modulo size depends on the mode and register size; 64-bit operands are available only in 64-bit mode). This allows any bit position to be selected.
- If the bit base operand specifies a memory location, the operand represents the address of the byte in memory that contains the bit base (bit 0 of the specified byte) of the bit string. The range of the bit position that can be referenced by the offset operand depends on the operand size.

See also: **Bit(BitBase, BitOffset)** on page 3-10.

Some assemblers support immediate bit offsets larger than 31 by using the immediate bit offset field in combination with the displacement field of the memory operand. See “BT—Bit Test” in this chapter for more information on this addressing mechanism.

This instruction can be used with a LOCK prefix to allow the instruction to be executed atomically.

In 64-bit mode, the instruction’s default operation size is 32 bits. Using a REX prefix in the form of REX.R permits access to additional registers (R8-R15). Using a REX

prefix in the form of REX.W promotes operation to 64 bits. See the summary chart at the beginning of this section for encoding data and limits.

Operation

CF ← Bit(BitBase, BitOffset);
Bit(BitBase, BitOffset) ← 1;

Flags Affected

The CF flag contains the value of the selected bit before it is set. The OF, SF, ZF, AF, and PF flags are undefined.

Protected Mode Exceptions

#GP(0)	If the destination operand points to a non-writable segment. If a memory operand effective address is outside the CS, DS, ES, FS, or GS segment limit. If the DS, ES, FS, or GS register contains a NULL segment selector.
#SS(0)	If a memory operand effective address is outside the SS segment limit.
#PF(fault-code)	If a page fault occurs.
#AC(0)	If alignment checking is enabled and an unaligned memory reference is made while the current privilege level is 3.
#UD	If the LOCK prefix is used but the destination is not a memory operand.

Real-Address Mode Exceptions

#GP	If a memory operand effective address is outside the CS, DS, ES, FS, or GS segment limit.
#SS	If a memory operand effective address is outside the SS segment limit.
#UD	If the LOCK prefix is used but the destination is not a memory operand.

Virtual-8086 Mode Exceptions

#GP	If a memory operand effective address is outside the CS, DS, ES, FS, or GS segment limit.
#SS	If a memory operand effective address is outside the SS segment limit.
#PF(fault-code)	If a page fault occurs.

INSTRUCTION SET REFERENCE, A-M

#AC(0)	If alignment checking is enabled and an unaligned memory reference is made.
#UD	If the LOCK prefix is used but the destination is not a memory operand.

Compatibility Mode Exceptions

Same exceptions as in protected mode.

64-Bit Mode Exceptions

#SS(0)	If a memory address referencing the SS segment is in a non-canonical form.
#GP(0)	If the memory address is in a non-canonical form.
#PF(fault-code)	If a page fault occurs.
#AC(0)	If alignment checking is enabled and an unaligned memory reference is made while the current privilege level is 3.
#UD	If the LOCK prefix is used but the destination is not a memory operand.

CALL—Call Procedure

Opcode	Instruction	64-Bit Mode	Compat/ Leg Mode	Description
E8 <i>cw</i>	CALL <i>rel16</i>	N.S.	Valid	Call near, relative, displacement relative to next instruction.
E8 <i>cd</i>	CALL <i>rel32</i>	Valid	Valid	Call near, relative, displacement relative to next instruction. 32-bit displacement sign extended to 64-bits in 64-bit mode.
FF /2	CALL <i>r/m16</i>	N.E.	Valid	Call near, absolute indirect, address given in <i>r/m16</i> .
FF /2	CALL <i>r/m32</i>	N.E.	Valid	Call near, absolute indirect, address given in <i>r/m32</i> .
FF /2	CALL <i>r/m64</i>	Valid	N.E.	Call near, absolute indirect, address given in <i>r/m64</i> .
9A <i>cd</i>	CALL <i>ptr16:16</i>	Invalid	Valid	Call far, absolute, address given in operand.
9A <i>cp</i>	CALL <i>ptr16:32</i>	Invalid	Valid	Call far, absolute, address given in operand.
FF /3	CALL <i>m16:16</i>	Valid	Valid	Call far, absolute indirect address given in <i>m16:16</i> . In 32-bit mode: if selector points to a gate, then RIP = 32-bit zero extended displacement taken from gate; else RIP = zero extended 16-bit offset from far pointer referenced in the instruction.
FF /3	CALL <i>m16:32</i>	Valid	Valid	In 64-bit mode: If selector points to a gate, then RIP = 64-bit displacement taken from gate; else RIP = zero extended 32-bit offset from far pointer referenced in the instruction.
REX.W + FF /3	CALL <i>m16:64</i>	Valid	N.E.	In 64-bit mode: If selector points to a gate, then RIP = 64-bit displacement taken from gate; else RIP = 64-bit offset from far pointer referenced in the instruction.

Description

Saves procedure linking information on the stack and branches to the called procedure specified using the target operand. The target operand specifies the address of

the first instruction in the called procedure. The operand can be an immediate value, a general-purpose register, or a memory location.

This instruction can be used to execute four types of calls:

- **Near Call** — A call to a procedure in the current code segment (the segment currently pointed to by the CS register), sometimes referred to as an intra-segment call.
- **Far Call** — A call to a procedure located in a different segment than the current code segment, sometimes referred to as an inter-segment call.
- **Inter-privilege-level far call** — A far call to a procedure in a segment at a different privilege level than that of the currently executing program or procedure.
- **Task switch** — A call to a procedure located in a different task.

The latter two call types (inter-privilege-level call and task switch) can only be executed in protected mode. See “Calling Procedures Using Call and RET” in Chapter 6 of the *Intel® 64 and IA-32 Architectures Software Developer’s Manual, Volume 1*, for additional information on near, far, and inter-privilege-level calls. See Chapter 7, “Task Management,” in the *Intel® 64 and IA-32 Architectures Software Developer’s Manual, Volume 3A*, for information on performing task switches with the CALL instruction.

Near Call. When executing a near call, the processor pushes the value of the EIP register (which contains the offset of the instruction following the CALL instruction) on the stack (for use later as a return-instruction pointer). The processor then branches to the address in the current code segment specified by the target operand. The target operand specifies either an absolute offset in the code segment (an offset from the base of the code segment) or a relative offset (a signed displacement relative to the current value of the instruction pointer in the EIP register; this value points to the instruction following the CALL instruction). The CS register is not changed on near calls.

For a near call absolute, an absolute offset is specified indirectly in a general-purpose register or a memory location (*r/m16*, *r/m32*, or *r/m64*). The operand-size attribute determines the size of the target operand (16, 32 or 64 bits). When in 64-bit mode, the operand size for near call (and all near branches) is forced to 64-bits. Absolute offsets are loaded directly into the EIP(RIP) register. If the operand size attribute is 16, the upper two bytes of the EIP register are cleared, resulting in a maximum instruction pointer size of 16 bits. When accessing an absolute offset indirectly using the stack pointer [ESP] as the base register, the base value used is the value of the ESP before the instruction executes.

A relative offset (*rel16* or *rel32*) is generally specified as a label in assembly code. But at the machine code level, it is encoded as a signed, 16- or 32-bit immediate value. This value is added to the value in the EIP(RIP) register. In 64-bit mode the relative offset is always a 32-bit immediate value which is sign extended to 64-bits before it is added to the value in the RIP register for the target calculation. As with absolute offsets, the operand-size attribute determines the size of the target operand (16, 32,

or 64 bits). In 64-bit mode the target operand will always be 64-bits because the operand size is forced to 64-bits for near branches.

Far Calls in Real-Address or Virtual-8086 Mode. When executing a far call in real-address or virtual-8086 mode, the processor pushes the current value of both the CS and EIP registers on the stack for use as a return-instruction pointer. The processor then performs a “far branch” to the code segment and offset specified with the target operand for the called procedure. The target operand specifies an absolute far address either directly with a pointer (*ptr16:16* or *ptr16:32*) or indirectly with a memory location (*m16:16* or *m16:32*). With the pointer method, the segment and offset of the called procedure is encoded in the instruction using a 4-byte (16-bit operand size) or 6-byte (32-bit operand size) far address immediate. With the indirect method, the target operand specifies a memory location that contains a 4-byte (16-bit operand size) or 6-byte (32-bit operand size) far address. The operand-size attribute determines the size of the offset (16 or 32 bits) in the far address. The far address is loaded directly into the CS and EIP registers. If the operand-size attribute is 16, the upper two bytes of the EIP register are cleared.

Far Calls in Protected Mode. When the processor is operating in protected mode, the CALL instruction can be used to perform the following types of far calls:

- Far call to the same privilege level
- Far call to a different privilege level (inter-privilege level call)
- Task switch (far call to another task)

In protected mode, the processor always uses the segment selector part of the far address to access the corresponding descriptor in the GDT or LDT. The descriptor type (code segment, call gate, task gate, or TSS) and access rights determine the type of call operation to be performed.

If the selected descriptor is for a code segment, a far call to a code segment at the same privilege level is performed. (If the selected code segment is at a different privilege level and the code segment is non-conforming, a general-protection exception is generated.) A far call to the same privilege level in protected mode is very similar to one carried out in real-address or virtual-8086 mode. The target operand specifies an absolute far address either directly with a pointer (*ptr16:16* or *ptr16:32*) or indirectly with a memory location (*m16:16* or *m16:32*). The operand-size attribute determines the size of the offset (16 or 32 bits) in the far address. The new code segment selector and its descriptor are loaded into CS register; the offset from the instruction is loaded into the EIP register.

A call gate (described in the next paragraph) can also be used to perform a far call to a code segment at the same privilege level. Using this mechanism provides an extra level of indirection and is the preferred method of making calls between 16-bit and 32-bit code segments.

When executing an inter-privilege-level far call, the code segment for the procedure being called must be accessed through a call gate. The segment selector specified by the target operand identifies the call gate. The target operand can specify the call gate segment selector either directly with a pointer (*ptr16:16* or *ptr16:32*) or indirectly with a memory location (*m16:16* or *m16:32*). The processor obtains the

segment selector for the new code segment and the new instruction pointer (offset) from the call gate descriptor. (The offset from the target operand is ignored when a call gate is used.)

On inter-privilege-level calls, the processor switches to the stack for the privilege level of the called procedure. The segment selector for the new stack segment is specified in the TSS for the currently running task. The branch to the new code segment occurs after the stack switch. (Note that when using a call gate to perform a far call to a segment at the same privilege level, no stack switch occurs.) On the new stack, the processor pushes the segment selector and stack pointer for the calling procedure's stack, an optional set of parameters from the calling procedure's stack, and the segment selector and instruction pointer for the calling procedure's code segment. (A value in the call gate descriptor determines how many parameters to copy to the new stack.) Finally, the processor branches to the address of the procedure being called within the new code segment.

Executing a task switch with the CALL instruction is similar to executing a call through a call gate. The target operand specifies the segment selector of the task gate for the new task activated by the switch (the offset in the target operand is ignored). The task gate in turn points to the TSS for the new task, which contains the segment selectors for the task's code and stack segments. Note that the TSS also contains the EIP value for the next instruction that was to be executed before the calling task was suspended. This instruction pointer value is loaded into the EIP register to re-start the calling task.

The CALL instruction can also specify the segment selector of the TSS directly, which eliminates the indirection of the task gate. See Chapter 7, "Task Management," in the *Intel® 64 and IA-32 Architectures Software Developer's Manual, Volume 3A*, for information on the mechanics of a task switch.

When you execute a task switch with a CALL instruction, the nested task flag (NT) is set in the EFLAGS register and the new TSS's previous task link field is loaded with the old task's TSS selector. Code is expected to suspend this nested task by executing an IRET instruction which, because the NT flag is set, automatically uses the previous task link to return to the calling task. (See "Task Linking" in Chapter 7 of the *Intel® 64 and IA-32 Architectures Software Developer's Manual, Volume 3A*, for information on nested tasks.) Switching tasks with the CALL instruction differs in this regard from JMP instruction. JMP does not set the NT flag and therefore does not expect an IRET instruction to suspend the task.

Mixing 16-Bit and 32-Bit Calls. When making far calls between 16-bit and 32-bit code segments, use a call gate. If the far call is from a 32-bit code segment to a 16-bit code segment, the call should be made from the first 64 KBytes of the 32-bit code segment. This is because the operand-size attribute of the instruction is set to 16, so only a 16-bit return address offset can be saved. Also, the call should be made using a 16-bit call gate so that 16-bit values can be pushed on the stack. See Chapter 17, "Mixing 16-Bit and 32-Bit Code," in the *Intel® 64 and IA-32 Architectures Software Developer's Manual, Volume 3A*, for more information.

Far Calls in Compatibility Mode. When the processor is operating in compatibility mode, the CALL instruction can be used to perform the following types of far calls:

- Far call to the same privilege level, remaining in compatibility mode
- Far call to the same privilege level, transitioning to 64-bit mode
- Far call to a different privilege level (inter-privilege level call), transitioning to 64-bit mode

Note that a CALL instruction can not be used to cause a task switch in compatibility mode since task switches are not supported in IA-32e mode.

In compatibility mode, the processor always uses the segment selector part of the far address to access the corresponding descriptor in the GDT or LDT. The descriptor type (code segment, call gate) and access rights determine the type of call operation to be performed.

If the selected descriptor is for a code segment, a far call to a code segment at the same privilege level is performed. (If the selected code segment is at a different privilege level and the code segment is non-conforming, a general-protection exception is generated.) A far call to the same privilege level in compatibility mode is very similar to one carried out in protected mode. The target operand specifies an absolute far address either directly with a pointer (*ptr16:16* or *ptr16:32*) or indirectly with a memory location (*m16:16* or *m16:32*). The operand-size attribute determines the size of the offset (16 or 32 bits) in the far address. The new code segment selector and its descriptor are loaded into CS register and the offset from the instruction is loaded into the EIP register. The difference is that 64-bit mode may be entered. This is specified by the L bit in the new code segment descriptor.

Note that a 64-bit call gate (described in the next paragraph) can also be used to perform a far call to a code segment at the same privilege level. However, using this mechanism requires that the target code segment descriptor have the L bit set, causing an entry to 64-bit mode.

When executing an inter-privilege-level far call, the code segment for the procedure being called must be accessed through a 64-bit call gate. The segment selector specified by the target operand identifies the call gate. The target operand can specify the call gate segment selector either directly with a pointer (*ptr16:16* or *ptr16:32*) or indirectly with a memory location (*m16:16* or *m16:32*). The processor obtains the segment selector for the new code segment and the new instruction pointer (offset) from the 16-byte call gate descriptor. (The offset from the target operand is ignored when a call gate is used.)

On inter-privilege-level calls, the processor switches to the stack for the privilege level of the called procedure. The segment selector for the new stack segment is set to NULL. The new stack pointer is specified in the TSS for the currently running task. The branch to the new code segment occurs after the stack switch. (Note that when using a call gate to perform a far call to a segment at the same privilege level, an implicit stack switch occurs as a result of entering 64-bit mode. The SS selector is unchanged, but stack segment accesses use a segment base of 0x0, the limit is ignored, and the default stack size is 64-bits. The full value of RSP is used for the offset, of which the upper 32-bits are undefined.) On the new stack, the processor

pushes the segment selector and stack pointer for the calling procedure's stack and the segment selector and instruction pointer for the calling procedure's code segment. (Parameter copy is not supported in IA-32e mode.) Finally, the processor branches to the address of the procedure being called within the new code segment.

Near/(Far) Calls in 64-bit Mode. When the processor is operating in 64-bit mode, the CALL instruction can be used to perform the following types of far calls:

- Far call to the same privilege level, transitioning to compatibility mode
- Far call to the same privilege level, remaining in 64-bit mode
- Far call to a different privilege level (inter-privilege level call), remaining in 64-bit mode

Note that in this mode the CALL instruction can not be used to cause a task switch in 64-bit mode since task switches are not supported in IA-32e mode.

In 64-bit mode, the processor always uses the segment selector part of the far address to access the corresponding descriptor in the GDT or LDT. The descriptor type (code segment, call gate) and access rights determine the type of call operation to be performed.

If the selected descriptor is for a code segment, a far call to a code segment at the same privilege level is performed. (If the selected code segment is at a different privilege level and the code segment is non-conforming, a general-protection exception is generated.) A far call to the same privilege level in 64-bit mode is very similar to one carried out in compatibility mode. The target operand specifies an absolute far address indirectly with a memory location (*m16:16*, *m16:32* or *m16:64*). The form of CALL with a direct specification of absolute far address is not defined in 64-bit mode. The operand-size attribute determines the size of the offset (16, 32, or 64 bits) in the far address. The new code segment selector and its descriptor are loaded into the CS register; the offset from the instruction is loaded into the EIP register. The new code segment may specify entry either into compatibility or 64-bit mode, based on the L bit value.

A 64-bit call gate (described in the next paragraph) can also be used to perform a far call to a code segment at the same privilege level. However, using this mechanism requires that the target code segment descriptor have the L bit set.

When executing an inter-privilege-level far call, the code segment for the procedure being called must be accessed through a 64-bit call gate. The segment selector specified by the target operand identifies the call gate. The target operand can only specify the call gate segment selector indirectly with a memory location (*m16:16*, *m16:32* or *m16:64*). The processor obtains the segment selector for the new code segment and the new instruction pointer (offset) from the 16-byte call gate descriptor. (The offset from the target operand is ignored when a call gate is used.)

On inter-privilege-level calls, the processor switches to the stack for the privilege level of the called procedure. The segment selector for the new stack segment is set to NULL. The new stack pointer is specified in the TSS for the currently running task. The branch to the new code segment occurs after the stack switch.

Note that when using a call gate to perform a far call to a segment at the same privilege level, an implicit stack switch occurs as a result of entering 64-bit mode. The SS selector is unchanged, but stack segment accesses use a segment base of 0x0, the limit is ignored, and the default stack size is 64-bits. (The full value of RSP is used for the offset.) On the new stack, the processor pushes the segment selector and stack pointer for the calling procedure's stack and the segment selector and instruction pointer for the calling procedure's code segment. (Parameter copy is not supported in IA-32e mode.) Finally, the processor branches to the address of the procedure being called within the new code segment.

Operation

```

IF near call
  THEN IF near relative call
    THEN
      IF OperandSize = 64
        THEN
          tempDEST ← SignExtend(DEST); (* DEST is rel32 *)
          tempRIP ← RIP + tempDEST;
          IF stack not large enough for a 8-byte return address
            THEN #SS(0); FI;
          Push(RIP);
          RIP ← tempRIP;
        FI;
      IF OperandSize = 32
        THEN
          tempEIP ← EIP + DEST; (* DEST is rel32 *)
          IF tempEIP is not within code segment limit THEN #GP(0); FI;
          IF stack not large enough for a 4-byte return address
            THEN #SS(0); FI;
          Push(EIP);
          EIP ← tempEIP;
        FI;
      IF OperandSize = 16
        THEN
          tempEIP ← (EIP + DEST) AND 0000FFFFH; (* DEST is rel16 *)
          IF tempEIP is not within code segment limit THEN #GP(0); FI;
          IF stack not large enough for a 2-byte return address
            THEN #SS(0); FI;
          Push(IP);
          EIP ← tempEIP;
        FI;
      ELSE (* Near absolute call *)
        IF OperandSize = 64

```

```

    THEN
        tempRIP ← DEST; (* DEST is r/m64 *)
        IF stack not large enough for a 8-byte return address
            THEN #SS(0); FI;
        Push(RIP);
        RIP ← tempRIP;
FI;
IF OperandSize = 32
    THEN
        tempEIP ← DEST; (* DEST is r/m32 *)
        IF tempEIP is not within code segment limit THEN #GP(0); FI;
        IF stack not large enough for a 4-byte return address
            THEN #SS(0); FI;
        Push(EIP);
        EIP ← tempEIP;
FI;
IF OperandSize = 16
    THEN
        tempEIP ← DEST AND 0000FFFFH; (* DEST is r/m16 *)
        IF tempEIP is not within code segment limit THEN #GP(0); FI;
        IF stack not large enough for a 2-byte return address
            THEN #SS(0); FI;
        Push(IP);
        EIP ← tempEIP;
FI;
FI;rel/abs
FI; near

IF far call and (PE = 0 or (PE = 1 and VM = 1)) (* Real-address or virtual-8086 mode *)
    THEN
        IF OperandSize = 32
            THEN
                IF stack not large enough for a 6-byte return address
                    THEN #SS(0); FI;
                IF DEST[31:16] is not zero THEN #GP(0); FI;
                Push(CS); (* Padded with 16 high-order bits *)
                Push(EIP);
                CS ← DEST[47:32]; (* DEST is ptr16:32 or [m16:32] *)
                EIP ← DEST[31:0]; (* DEST is ptr16:32 or [m16:32] *)
            ELSE (* OperandSize = 16 *)
                IF stack not large enough for a 4-byte return address
                    THEN #SS(0); FI;
                Push(CS);

```



```

        Push(IP);
        CS ← DEST[31:16]; (* DEST is ptr16:16 or [m16:16] *)
        EIP ← DEST[15:0]; (* DEST is ptr16:16 or [m16:16]; clear upper 16 bits *)
    FI;
FI;

IF far call and (PE = 1 and VM = 0) (* Protected mode or IA-32e Mode, not virtual-8086 mode*)
    THEN
        IF segment selector in target operand NULL
            THEN #GP(0); FI;
        IF segment selector index not within descriptor table limits
            THEN #GP(new code segment selector); FI;
        Read type and access rights of selected segment descriptor;
        IF IA32_EFER.LMA = 0
            THEN
                IF segment type is not a conforming or nonconforming code segment, call
                gate, task gate, or TSS
                    THEN #GP(segment selector); FI;
            ELSE
                IF segment type is not a conforming or nonconforming code segment or
                64-bit call gate,
                    THEN #GP(segment selector); FI;
        FI;
        Depending on type and access rights:
            GO TO CONFORMING-CODE-SEGMENT;
            GO TO NONCONFORMING-CODE-SEGMENT;
            GO TO CALL-GATE;
            GO TO TASK-GATE;
            GO TO TASK-STATE-SEGMENT;
    FI;

CONFORMING-CODE-SEGMENT:
    IF L-Bit = 1 and D-BIT = 1 and IA32_EFER.LMA = 1
        THEN GP(new code segment selector); FI;
    IF DPL > CPL
        THEN #GP(new code segment selector); FI;
    IF segment not present
        THEN #NP(new code segment selector); FI;
    IF stack not large enough for return address
        THEN #SS(0); FI;
    tempEIP ← DEST(Offset);
    IF OperandSize = 16
        THEN

```

```

        tempEIP ← tempEIP AND 0000FFFFH; FI; (* Clear upper 16 bits *)
IF (EFER.LMA = 0 or target mode = Compatibility mode) and (tempEIP outside new code
segment limit)
    THEN #GP(0); FI;
IF tempEIP is non-canonical
    THEN #GP(0); FI;
IF OperandSize = 32
    THEN
        Push(CS); (* Padded with 16 high-order bits *)
        Push(EIP);
        CS ← DEST(CodeSegmentSelector);
        (* Segment descriptor information also loaded *)
        CS(RPL) ← CPL;
        EIP ← tempEIP;
    ELSE
        IF OperandSize = 16
            THEN
                Push(CS);
                Push(IP);
                CS ← DEST(CodeSegmentSelector);
                (* Segment descriptor information also loaded *)
                CS(RPL) ← CPL;
                EIP ← tempEIP;
            ELSE (* OperandSize = 64 *)
                Push(CS); (* Padded with 48 high-order bits *)
                Push(RIP);
                CS ← DEST(CodeSegmentSelector);
                (* Segment descriptor information also loaded *)
                CS(RPL) ← CPL;
                RIP ← tempEIP;
            FI;
        FI;
END;

```

NONCONFORMING-CODE-SEGMENT:

```

IF L-Bit = 1 and D-BIT = 1 and IA32_EFER.LMA = 1
    THEN #GP(new code segment selector); FI;
IF (RPL > CPL) or (DPL ≠ CPL)
    THEN #GP(new code segment selector); FI;
IF segment not present
    THEN #NP(new code segment selector); FI;
IF stack not large enough for return address
    THEN #SS(0); FI;

```

```

tempEIP ← DEST(Offset);
IF OperandSize = 16
    THEN tempEIP ← tempEIP AND 0000FFFFH; FI; (* Clear upper 16 bits *)
IF (EFER.LMA = 0 or target mode = Compatibility mode) and (tempEIP outside new code
segment limit)
    THEN #GP(0); FI;
IF tempEIP is non-canonical
    THEN #GP(0); FI;
IF OperandSize = 32
    THEN
        Push(CS); (* Padded with 16 high-order bits *)
        Push(EIP);
        CS ← DEST(CodeSegmentSelector);
        (* Segment descriptor information also loaded *)
        CS(RPL) ← CPL;
        EIP ← tempEIP;
    ELSE
        IF OperandSize = 16
            THEN
                Push(CS);
                Push(IP);
                CS ← DEST(CodeSegmentSelector);
                (* Segment descriptor information also loaded *)
                CS(RPL) ← CPL;
                EIP ← tempEIP;
            ELSE (* OperandSize = 64 *)
                Push(CS); (* Padded with 48 high-order bits *)
                Push(RIP);
                CS ← DEST(CodeSegmentSelector);
                (* Segment descriptor information also loaded *)
                CS(RPL) ← CPL;
                RIP ← tempEIP;
            FI;
        FI;
END;

CALL-GATE:
IF call gate (DPL < CPL) or (RPL > DPL)
    THEN #GP(call gate selector); FI;
IF call gate not present
    THEN #NP(call gate selector); FI;
IF call gate code-segment selector is NULL
    THEN #GP(0); FI;
IF call gate code-segment selector index is outside descriptor table limits

```

```

    THEN #GP(code segment selector); FI;
Read code segment descriptor;
IF code-segment segment descriptor does not indicate a code segment
or code-segment segment descriptor DPL > CPL
    THEN #GP(code segment selector); FI;
IF IA32_EFER.LMA = 1 AND (code-segment segment descriptor is
not a 64-bit code segment or code-segment descriptor has both L-Bit and D-bit set)
    THEN #GP(code segment selector); FI;
IF code segment not present
    THEN #NP(new code segment selector); FI;
IF code segment is non-conforming and DPL < CPL
    THEN go to MORE-PRIVILEGE;
    ELSE go to SAME-PRIVILEGE;
FI;
END;

MORE-PRIVILEGE:
IF current TSS is 32-bit TSS
    THEN
        TSSstackAddress ← new code segment (DPL * 8) + 4;
        IF (TSSstackAddress + 7) > TSS limit
            THEN #TS(current TSS selector); FI;
        newSS ← TSSstackAddress + 4;
        newESP ← stack address;
    ELSE
        IF current TSS is 16-bit TSS
            THEN
                TSSstackAddress ← new code segment (DPL * 4) + 2;
                IF (TSSstackAddress + 4) > TSS limit
                    THEN #TS(current TSS selector); FI;
                newESP ← TSSstackAddress;
                newSS ← TSSstackAddress + 2;
            ELSE (* TSS is 64-bit *)
                TSSstackAddress ← new code segment (DPL * 8) + 4;
                IF (TSSstackAddress + 8) > TSS limit
                    THEN #TS(current TSS selector); FI;
                newESP ← TSSstackAddress;
                newSS ← NULL;
        FI;
    FI;
IF IA32_EFER.LMA = 0 and stack segment selector = NULL
    THEN #TS(stack segment selector); FI;
Read code segment descriptor;
IF IA32_EFER.LMA = 0 and (stack segment selector's RPL ≠ DPL of code segment

```

or stack segment DPL \neq DPL of code segment or stack segment is not a writable data segment)

THEN #TS(SS selector); FI

IF IA32_EFER.LMA = 0 and stack segment not present

THEN #SS(SS selector); FI;

IF CallGateSize = 32

THEN

IF stack does not have room for parameters plus 16 bytes

THEN #SS(SS selector); FI;

IF CallGate(InstructionPointer) not within code segment limit

THEN #GP(0); FI;

SS \leftarrow newSS;

(* Segment descriptor information also loaded *)

ESP \leftarrow newESP;

CS:EIP \leftarrow CallGate(CS:InstructionPointer);

(* Segment descriptor information also loaded *)

Push(oldSS:oldESP); (* From calling procedure *)

temp \leftarrow parameter count from call gate, masked to 5 bits;

Push(parameters from calling procedure's stack, temp)

Push(oldCS:oldEIP); (* Return address to calling procedure *)

ELSE

IF CallGateSize = 16

THEN

IF stack does not have room for parameters plus 8 bytes

THEN #SS(SS selector); FI;

IF (CallGate(InstructionPointer) AND FFFFH) not in code segment limit

THEN #GP(0); FI;

SS \leftarrow newSS;

(* Segment descriptor information also loaded *)

ESP \leftarrow newESP;

CS:IP \leftarrow CallGate(CS:InstructionPointer);

(* Segment descriptor information also loaded *)

Push(oldSS:oldESP); (* From calling procedure *)

temp \leftarrow parameter count from call gate, masked to 5 bits;

Push(parameters from calling procedure's stack, temp)

Push(oldCS:oldEIP); (* Return address to calling procedure *)

ELSE (* CallGateSize = 64 *)

IF pushing 32 bytes on the stack touches non-canonical addresses

THEN #SS(SS selector); FI;

IF (CallGate(InstructionPointer) is non-canonical)

THEN #GP(0); FI;

SS \leftarrow newSS; (* New SS is NULL)

RSP \leftarrow newESP;

CS:IP \leftarrow CallGate(CS:InstructionPointer);

INSTRUCTION SET REFERENCE, A-M

```
(* Segment descriptor information also loaded *)
Push(oldSS:oldESP); (* From calling procedure *)
Push(oldCS:oldEIP); (* Return address to calling procedure *)

    FI;
FI;
CPL ← CodeSegment(DPL)
CS(RPL) ← CPL
END;

SAME-PRIVILEGE:
    IF CallGateSize = 32
        THEN
            IF stack does not have room for 8 bytes
                THEN #SS(0); FI;
            IF CallGate(InstructionPointer) not within code segment limit
                THEN #GP(0); FI;
            CS:EIP ← CallGate(CS:EIP) (* Segment descriptor information also loaded *)
            Push(oldCS:oldEIP); (* Return address to calling procedure *)
        ELSE
            IF CallGateSize = 16
                THEN
                    IF stack does not have room for 4 bytes
                        THEN #SS(0); FI;
                    IF CallGate(InstructionPointer) not within code segment limit
                        THEN #GP(0); FI;
                    CS:IP ← CallGate(CS:instruction pointer);
                    (* Segment descriptor information also loaded *)
                    Push(oldCS:oldIP); (* Return address to calling procedure *)
                ELSE (* CallGateSize = 64)
                    IF pushing 16 bytes on the stack touches non-canonical addresses
                        THEN #SS(0); FI;
                    IF RIP non-canonical
                        THEN #GP(0); FI;
                    CS:IP ← CallGate(CS:instruction pointer);
                    (* Segment descriptor information also loaded *)
                    Push(oldCS:oldIP); (* Return address to calling procedure *)

                FI;
            FI;
            CS(RPL) ← CPL
        END;

TASK-GATE:
    IF task gate DPL < CPL or RPL
```

```

        THEN #GP(task gate selector); FI;
IF task gate not present
    THEN #NP(task gate selector); FI;
Read the TSS segment selector in the task-gate descriptor;
IF TSS segment selector local/global bit is set to local
or index not within GDT limits
    THEN #GP(TSS selector); FI;
Access TSS descriptor in GDT;
IF TSS descriptor specifies that the TSS is busy (low-order 5 bits set to 00001)
    THEN #GP(TSS selector); FI;
IF TSS not present
    THEN #NP(TSS selector); FI;
SWITCH-TASKS (with nesting) to TSS;
IF EIP not within code segment limit
    THEN #GP(0); FI;
END;

```

```

TASK-STATE-SEGMENT:
    IF TSS DPL < CPL or RPL
    or TSS descriptor indicates TSS not available
        THEN #GP(TSS selector); FI;
    IF TSS is not present
        THEN #NP(TSS selector); FI;
    SWITCH-TASKS (with nesting) to TSS;
    IF EIP not within code segment limit
        THEN #GP(0); FI;
END;

```

Flags Affected

All flags are affected if a task switch occurs; no flags are affected if a task switch does not occur.

Protected Mode Exceptions

#GP(0)	<p>If the target offset in destination operand is beyond the new code segment limit.</p> <p>If the segment selector in the destination operand is NULL.</p> <p>If the code segment selector in the gate is NULL.</p> <p>If a memory operand effective address is outside the CS, DS, ES, FS, or GS segment limit.</p> <p>If the DS, ES, FS, or GS register is used to access memory and it contains a NULL segment selector.</p>
--------	----------------------------------------------------------------------------------------------------------------------------------------------------------------------------------------------------------------------------------------------------------------------------------------------------------------------------------------------------------------------------------------------------------------------------------

#GP(selector)	<p>If a code segment or gate or TSS selector index is outside descriptor table limits.</p> <p>If the segment descriptor pointed to by the segment selector in the destination operand is not for a conforming-code segment, nonconforming-code segment, call gate, task gate, or task state segment.</p> <p>If the DPL for a nonconforming-code segment is not equal to the CPL or the RPL for the segment's segment selector is greater than the CPL.</p> <p>If the DPL for a conforming-code segment is greater than the CPL.</p> <p>If the DPL from a call-gate, task-gate, or TSS segment descriptor is less than the CPL or than the RPL of the call-gate, task-gate, or TSS's segment selector.</p> <p>If the segment descriptor for a segment selector from a call gate does not indicate it is a code segment.</p> <p>If the segment selector from a call gate is beyond the descriptor table limits.</p> <p>If the DPL for a code-segment obtained from a call gate is greater than the CPL.</p> <p>If the segment selector for a TSS has its local/global bit set for local.</p> <p>If a TSS segment descriptor specifies that the TSS is busy or not available.</p>
#SS(0)	<p>If pushing the return address, parameters, or stack segment pointer onto the stack exceeds the bounds of the stack segment, when no stack switch occurs.</p> <p>If a memory operand effective address is outside the SS segment limit.</p>
#SS(selector)	<p>If pushing the return address, parameters, or stack segment pointer onto the stack exceeds the bounds of the stack segment, when a stack switch occurs.</p> <p>If the SS register is being loaded as part of a stack switch and the segment pointed to is marked not present.</p> <p>If stack segment does not have room for the return address, parameters, or stack segment pointer, when stack switch occurs.</p>
#NP(selector)	<p>If a code segment, data segment, stack segment, call gate, task gate, or TSS is not present.</p>
#TS(selector)	<p>If the new stack segment selector and ESP are beyond the end of the TSS.</p> <p>If the new stack segment selector is NULL.</p>

If the RPL of the new stack segment selector in the TSS is not equal to the DPL of the code segment being accessed.
 If DPL of the stack segment descriptor for the new stack segment is not equal to the DPL of the code segment descriptor.
 If the new stack segment is not a writable data segment.
 If segment-selector index for stack segment is outside descriptor table limits.

#PF(fault-code)	If a page fault occurs.
#AC(0)	If alignment checking is enabled and an unaligned memory reference is made while the current privilege level is 3.
#UD	If the LOCK prefix is used.

Real-Address Mode Exceptions

#GP	If a memory operand effective address is outside the CS, DS, ES, FS, or GS segment limit. If the target offset is beyond the code segment limit.
#UD	If the LOCK prefix is used.

Virtual-8086 Mode Exceptions

#GP(0)	If a memory operand effective address is outside the CS, DS, ES, FS, or GS segment limit. If the target offset is beyond the code segment limit.
#PF(fault-code)	If a page fault occurs.
#AC(0)	If alignment checking is enabled and an unaligned memory reference is made.
#UD	If the LOCK prefix is used.

Compatibility Mode Exceptions

Same exceptions as in protected mode.

#GP(selector)	If a memory address accessed by the selector is in non-canonical space.
#GP(0)	If the target offset in the destination operand is non-canonical.

64-Bit Mode Exceptions

#GP(0)	If a memory address is non-canonical. If target offset in destination operand is non-canonical. If the segment selector in the destination operand is NULL. If the code segment selector in the 64-bit gate is NULL.
#GP(selector)	If code segment or 64-bit call gate is outside descriptor table limits.

	If code segment or 64-bit call gate overlaps non-canonical space.
	If the segment descriptor pointed to by the segment selector in the destination operand is not for a conforming-code segment, nonconforming-code segment, or 64-bit call gate.
	If the segment descriptor pointed to by the segment selector in the destination operand is a code segment and has both the D-bit and the L-bit set.
	If the DPL for a nonconforming-code segment is not equal to the CPL, or the RPL for the segment's segment selector is greater than the CPL.
	If the DPL for a conforming-code segment is greater than the CPL.
	If the DPL from a 64-bit call-gate is less than the CPL or than the RPL of the 64-bit call-gate.
	If the upper type field of a 64-bit call gate is not 0x0.
	If the segment selector from a 64-bit call gate is beyond the descriptor table limits.
	If the DPL for a code-segment obtained from a 64-bit call gate is greater than the CPL.
	If the code segment descriptor pointed to by the selector in the 64-bit gate doesn't have the L-bit set and the D-bit clear.
	If the segment descriptor for a segment selector from the 64-bit call gate does not indicate it is a code segment.
#SS(0)	If pushing the return offset or CS selector onto the stack exceeds the bounds of the stack segment when no stack switch occurs.
	If a memory operand effective address is outside the SS segment limit.
	If the stack address is in a non-canonical form.
#SS(selector)	If pushing the old values of SS selector, stack pointer, EFLAGS, CS selector, offset, or error code onto the stack violates the canonical boundary when a stack switch occurs.
#NP(selector)	If a code segment or 64-bit call gate is not present.
#TS(selector)	If the load of the new RSP exceeds the limit of the TSS.
#UD	(64-bit mode only) If a far call is direct to an absolute address in memory.
	If the LOCK prefix is used.
#PF(fault-code)	If a page fault occurs.
#AC(0)	If alignment checking is enabled and an unaligned memory reference is made while the current privilege level is 3.

CBW/CWDE/CDQE—Convert Byte to Word/Convert Word to Doubleword/Convert Doubleword to Quadword

Opcode	Instruction	64-Bit Mode	Compat/Leg Mode	Description
98	CBW	Valid	Valid	AX ← sign-extend of AL.
98	CWDE	Valid	Valid	EAX ← sign-extend of AX.
REX.W + 98	CDQE	Valid	N.E.	RAX ← sign-extend of EAX.

Description

Double the size of the source operand by means of sign extension. The CBW (convert byte to word) instruction copies the sign (bit 7) in the source operand into every bit in the AH register. The CWDE (convert word to doubleword) instruction copies the sign (bit 15) of the word in the AX register into the high 16 bits of the EAX register.

CBW and CWDE reference the same opcode. The CBW instruction is intended for use when the operand-size attribute is 16; CWDE is intended for use when the operand-size attribute is 32. Some assemblers may force the operand size. Others may treat these two mnemonics as synonyms (CBW/CWDE) and use the setting of the operand-size attribute to determine the size of values to be converted.

In 64-bit mode, the default operation size is the size of the destination register. Use of the REX.W prefix promotes this instruction (CDQE when promoted) to operate on 64-bit operands. In which case, CDQE copies the sign (bit 31) of the doubleword in the EAX register into the high 32 bits of RAX.

Operation

```
IF OperandSize = 16 (* Instruction = CBW *)
  THEN
    AX ← SignExtend(AL);
  ELSE IF (OperandSize = 32, Instruction = CWDE)
    EAX ← SignExtend(AX); FI;
  ELSE (* 64-Bit Mode, OperandSize = 64, Instruction = CDQE*)
    RAX ← SignExtend(EAX);
  FI;
```

Flags Affected

None.

Exceptions (All Operating Modes)

#UD If the LOCK prefix is used.

CLC—Clear Carry Flag

Opcode	Instruction	64-Bit Mode	Compat/ Leg Mode	Description
F8	CLC	Valid	Valid	Clear CF flag.

Description

Clears the CF flag in the EFLAGS register. Operation is the same in all non-64-bit modes and 64-bit mode.

Operation

CF ← 0;

Flags Affected

The CF flag is set to 0. The OF, ZF, SF, AF, and PF flags are unaffected.

Exceptions (All Operating Modes)

#UD If the LOCK prefix is used.

CLD—Clear Direction Flag

Opcode	Instruction	64-Bit Mode	Compat/Leg Mode	Description
FC	CLD	Valid	Valid	Clear DF flag.

Description

Clears the DF flag in the EFLAGS register. When the DF flag is set to 0, string operations increment the index registers (ESI and/or EDI). Operation is the same in all non-64-bit modes and 64-bit mode.

Operation

DF ← 0;

Flags Affected

The DF flag is set to 0. The CF, OF, ZF, SF, AF, and PF flags are unaffected.

Exceptions (All Operating Modes)

#UD If the LOCK prefix is used.

CLFLUSH—Flush Cache Line

Opcode	Instruction	64-Bit Mode	Compat/ Leg Mode	Description
0F AE /7	CLFLUSH <i>m8</i>	Valid	Valid	Flushes cache line containing <i>m8</i> .

Description

Invalidates the cache line that contains the linear address specified with the source operand from all levels of the processor cache hierarchy (data and instruction). The invalidation is broadcast throughout the cache coherence domain. If, at any level of the cache hierarchy, the line is inconsistent with memory (dirty) it is written to memory before invalidation. The source operand is a byte memory location.

The availability of CLFLUSH is indicated by the presence of the CPUID feature flag CLFSH (bit 19 of the EDX register, see “CPUID—CPU Identification” in this chapter). The aligned cache line size affected is also indicated with the CPUID instruction (bits 8 through 15 of the EBX register when the initial value in the EAX register is 1).

The memory attribute of the page containing the affected line has no effect on the behavior of this instruction. It should be noted that processors are free to speculatively fetch and cache data from system memory regions assigned a memory-type allowing for speculative reads (such as, the WB, WC, and WT memory types). PREFETCH h instructions can be used to provide the processor with hints for this speculative behavior. Because this speculative fetching can occur at any time and is not tied to instruction execution, the CLFLUSH instruction is not ordered with respect to PREFETCH h instructions or any of the speculative fetching mechanisms (that is, data can be speculatively loaded into a cache line just before, during, or after the execution of a CLFLUSH instruction that references the cache line).

CLFLUSH is only ordered by the MFENCE instruction. It is not guaranteed to be ordered by any other fencing or serializing instructions or by another CLFLUSH instruction. For example, software can use an MFENCE instruction to insure that previous stores are included in the write-back.

The CLFLUSH instruction can be used at all privilege levels and is subject to all permission checking and faults associated with a byte load (and in addition, a CLFLUSH instruction is allowed to flush a linear address in an execute-only segment). Like a load, the CLFLUSH instruction sets the A bit but not the D bit in the page tables.

The CLFLUSH instruction was introduced with the SSE2 extensions; however, because it has its own CPUID feature flag, it can be implemented in IA-32 processors that do not include the SSE2 extensions. Also, detecting the presence of the SSE2 extensions with the CPUID instruction does not guarantee that the CLFLUSH instruction is implemented in the processor.

CLFLUSH operation is the same in non-64-bit modes and 64-bit mode.

Operation

Flush_Cache_Line(SRC);

Intel C/C++ Compiler Intrinsic Equivalents

CLFLUSH void _mm_clflush(void const *p)

Protected Mode Exceptions

#GP(0)	For an illegal memory operand effective address in the CS, DS, ES, FS or GS segments.
#SS(0)	For an illegal address in the SS segment.
#PF(fault-code)	For a page fault.
#UD	If CPUID.01H: EDX.CLFSH[bit 19] = 0. If the LOCK prefix is used.

Real-Address Mode Exceptions

GP	If any part of the operand lies outside the effective address space from 0 to FFFFH.
#UD	If CPUID.01H: EDX.CLFSH[bit 19] = 0. If the LOCK prefix is used.

Virtual-8086 Mode Exceptions

Same exceptions as in real address mode.

#PF(fault-code)	For a page fault.
-----------------	-------------------

Compatibility Mode Exceptions

Same exceptions as in protected mode.

64-Bit Mode Exceptions

#SS(0)	If a memory address referencing the SS segment is in a non-canonical form.
#GP(0)	If the memory address is in a non-canonical form.
#PF(fault-code)	For a page fault.
#UD	If CPUID.01H: EDX.CLFSH[bit 19] = 0. If the LOCK prefix is used.

CLI – Clear Interrupt Flag

Opcode	Instruction	64-Bit Mode	Compat/Leg Mode	Description
FA	CLI	Valid	Valid	Clear interrupt flag; interrupts disabled when interrupt flag cleared.

Description

If protected-mode virtual interrupts are not enabled, CLI clears the IF flag in the EFLAGS register. No other flags are affected. Clearing the IF flag causes the processor to ignore maskable external interrupts. The IF flag and the CLI and STI instruction have no effect on the generation of exceptions and NMI interrupts.

When protected-mode virtual interrupts are enabled, CPL is 3, and IOPL is less than 3; CLI clears the VIF flag in the EFLAGS register, leaving IF unaffected. Table 3-14 indicates the action of the CLI instruction depending on the processor operating mode and the CPL/IOPL of the running program or procedure.

CLI operation is the same in non-64-bit modes and 64-bit mode.

Table 3-14. Decision Table for CLI Results

PE	VM	IOPL	CPL	PVI	VIP	VME	CLI Result
0	X	X	X	X	X	X	IF = 0
1	0	≥ CPL	X	X	X	X	IF = 0
1	0	< CPL	3	1	X	X	VIF = 0
1	0	< CPL	< 3	X	X	X	GP Fault
1	0	< CPL	X	0	X	X	GP Fault
1	1	3	X	X	X	X	IF = 0
1	1	< 3	X	X	X	1	VIF = 0
1	1	< 3	X	X	X	0	GP Fault

NOTES:

* X = This setting has no impact.

Operation

```

IF PE = 0
  THEN
    IF ← 0; (* Reset Interrupt Flag *)
  ELSE
    IF VM = 0;
      THEN

```



```

    IF IOPL ≥ CPL
        THEN
            IF ← 0; (* Reset Interrupt Flag *)
        ELSE
            IF ((IOPL < CPL) and (CPL = 3) and (PVI = 1))
                THEN
                    VIF ← 0; (* Reset Virtual Interrupt Flag *)
                ELSE
                    #GP(0);
            FI;
        FI;
    ELSE (* VM = 1 *)
        IF IOPL = 3
            THEN
                IF ← 0; (* Reset Interrupt Flag *)
            ELSE
                IF (IOPL < 3) AND (VME = 1)
                    THEN
                        VIF ← 0; (* Reset Virtual Interrupt Flag *)
                    ELSE
                        #GP(0);
                FI;
            FI;
        FI;
    FI;

```

Flags Affected

If protected-mode virtual interrupts are not enabled, IF is set to 0 if the CPL is equal to or less than the IOPL; otherwise, it is not affected. The other flags in the EFLAGS register are unaffected.

When protected-mode virtual interrupts are enabled, CPL is 3, and IOPL is less than 3; CLI clears the VIF flag in the EFLAGS register, leaving IF unaffected.

Protected Mode Exceptions

#GP(0)	If the CPL is greater (has less privilege) than the IOPL of the current program or procedure.
#UD	If the LOCK prefix is used.

Real-Address Mode Exceptions

#UD	If the LOCK prefix is used.
-----	-----------------------------

Virtual-8086 Mode Exceptions

- #GP(0) If the CPL is greater (has less privilege) than the IOPL of the current program or procedure.
- #UD If the LOCK prefix is used.

Compatibility Mode Exceptions

Same exceptions as in protected mode.

64-Bit Mode Exceptions

- #GP(0) If the CPL is greater (has less privilege) than the IOPL of the current program or procedure.
- #UD If the LOCK prefix is used.

CLTS—Clear Task-Switched Flag in CR0

Opcode	Instruction	64-Bit Mode	Compat/ Leg Mode	Description
0F 06	CLTS	Valid	Valid	Clears TS flag in CR0.

Description

Clears the task-switched (TS) flag in the CR0 register. This instruction is intended for use in operating-system procedures. It is a privileged instruction that can only be executed at a CPL of 0. It is allowed to be executed in real-address mode to allow initialization for protected mode.

The processor sets the TS flag every time a task switch occurs. The flag is used to synchronize the saving of FPU context in multitasking applications. See the description of the TS flag in the section titled “Control Registers” in Chapter 2 of the *Intel® 64 and IA-32 Architectures Software Developer’s Manual, Volume 3A*, for more information about this flag.

CLTS operation is the same in non-64-bit modes and 64-bit mode.

See Chapter 22, “VMX Non-Root Operation,” of the *Intel® 64 and IA-32 Architectures Software Developer’s Manual, Volume 3B*, for more information about the behavior of this instruction in VMX non-root operation.

Operation

CR0.TS[bit 3] ← 0;

Flags Affected

The TS flag in CR0 register is cleared.

Protected Mode Exceptions

#GP(0) If the current privilege level is not 0.
If the LOCK prefix is used.

Real-Address Mode Exceptions

#UD If the LOCK prefix is used.

Virtual-8086 Mode Exceptions

#GP(0) CLTS is not recognized in virtual-8086 mode.
#UD If the LOCK prefix is used.

Compatibility Mode Exceptions

Same exceptions as in protected mode.

64-Bit Mode Exceptions

#GP(0) If the CPL is greater than 0.

#UD If the LOCK prefix is used.

CMC—Complement Carry Flag

Opcode	Instruction	64-Bit Mode	Compat/ Leg Mode	Description
F5	CMC	Valid	Valid	Complement CF flag.

Description

Complements the CF flag in the EFLAGS register. CMC operation is the same in non-64-bit modes and 64-bit mode.

Operation

$EFLAGS.CF[\text{bit } 0] \leftarrow \text{NOT } EFLAGS.CF[\text{bit } 0];$

Flags Affected

The CF flag contains the complement of its original value. The OF, ZF, SF, AF, and PF flags are unaffected.

Exceptions (All Operating Modes)

#UD If the LOCK prefix is used.

CMOVcc—Conditional Move

Opcode	Instruction	64-Bit Mode	Compat/ Leg Mode	Description
OF 47 /r	CMOVA <i>r16, r/m16</i>	Valid	Valid	Move if above (CF=0 and ZF=0).
OF 47 /r	CMOVA <i>r32, r/m32</i>	Valid	Valid	Move if above (CF=0 and ZF=0).
REX.W + OF 47 /r	CMOVA <i>r64, r/m64</i>	Valid	N.E.	Move if above (CF=0 and ZF=0).
OF 43 /r	CMOVAE <i>r16, r/m16</i>	Valid	Valid	Move if above or equal (CF=0).
OF 43 /r	CMOVAE <i>r32, r/m32</i>	Valid	Valid	Move if above or equal (CF=0).
REX.W + OF 43 /r	CMOVAE <i>r64, r/m64</i>	Valid	N.E.	Move if above or equal (CF=0).
OF 42 /r	CMOVB <i>r16, r/m16</i>	Valid	Valid	Move if below (CF=1).
OF 42 /r	CMOVB <i>r32, r/m32</i>	Valid	Valid	Move if below (CF=1).
REX.W + OF 42 /r	CMOVB <i>r64, r/m64</i>	Valid	N.E.	Move if below (CF=1).
OF 46 /r	CMOVBE <i>r16, r/m16</i>	Valid	Valid	Move if below or equal (CF=1 or ZF=1).
OF 46 /r	CMOVBE <i>r32, r/m32</i>	Valid	Valid	Move if below or equal (CF=1 or ZF=1).
REX.W + OF 46 /r	CMOVBE <i>r64, r/m64</i>	Valid	N.E.	Move if below or equal (CF=1 or ZF=1).
OF 42 /r	CMOVC <i>r16, r/m16</i>	Valid	Valid	Move if carry (CF=1).
OF 42 /r	CMOVC <i>r32, r/m32</i>	Valid	Valid	Move if carry (CF=1).
REX.W + OF 42 /r	CMOVC <i>r64, r/m64</i>	Valid	N.E.	Move if carry (CF=1).
OF 44 /r	CMOVE <i>r16, r/m16</i>	Valid	Valid	Move if equal (ZF=1).
OF 44 /r	CMOVE <i>r32, r/m32</i>	Valid	Valid	Move if equal (ZF=1).
REX.W + OF 44 /r	CMOVE <i>r64, r/m64</i>	Valid	N.E.	Move if equal (ZF=1).
OF 4F /r	CMOVG <i>r16, r/m16</i>	Valid	Valid	Move if greater (ZF=0 and SF=OF).
OF 4F /r	CMOVG <i>r32, r/m32</i>	Valid	Valid	Move if greater (ZF=0 and SF=OF).
REX.W + OF 4F /r	CMOVG <i>r64, r/m64</i>	Valid	N.E.	Move if greater (ZF=0 and SF=OF).
OF 4D /r	CMOVGE <i>r16, r/m16</i>	Valid	Valid	Move if greater or equal (SF=OF).

Opcode	Instruction	64-Bit Mode	Compat/ Leg Mode	Description
OF 4D /r	CMOVGE r32, r/m32	Valid	Valid	Move if greater or equal (SF=OF).
REX.W + OF 4D /r	CMOVGE r64, r/m64	Valid	N.E.	Move if greater or equal (SF=OF).
OF 4C /r	CMOVL r16, r/m16	Valid	Valid	Move if less (SF≠ OF).
OF 4C /r	CMOVL r32, r/m32	Valid	Valid	Move if less (SF≠ OF).
REX.W + OF 4C /r	CMOVL r64, r/m64	Valid	N.E.	Move if less (SF≠ OF).
OF 4E /r	CMOVLE r16, r/m16	Valid	Valid	Move if less or equal (ZF=1 or SF≠ OF).
OF 4E /r	CMOVLE r32, r/m32	Valid	Valid	Move if less or equal (ZF=1 or SF≠ OF).
REX.W + OF 4E /r	CMOVLE r64, r/m64	Valid	N.E.	Move if less or equal (ZF=1 or SF≠ OF).
OF 46 /r	CMOVNA r16, r/m16	Valid	Valid	Move if not above (CF=1 or ZF=1).
OF 46 /r	CMOVNA r32, r/m32	Valid	Valid	Move if not above (CF=1 or ZF=1).
REX.W + OF 46 /r	CMOVNA r64, r/m64	Valid	N.E.	Move if not above (CF=1 or ZF=1).
OF 42 /r	CMOVNAE r16, r/m16	Valid	Valid	Move if not above or equal (CF=1).
OF 42 /r	CMOVNAE r32, r/m32	Valid	Valid	Move if not above or equal (CF=1).
REX.W + OF 42 /r	CMOVNAE r64, r/m64	Valid	N.E.	Move if not above or equal (CF=1).
OF 43 /r	CMOVNB r16, r/m16	Valid	Valid	Move if not below (CF=0).
OF 43 /r	CMOVNB r32, r/m32	Valid	Valid	Move if not below (CF=0).
REX.W + OF 43 /r	CMOVNB r64, r/m64	Valid	N.E.	Move if not below (CF=0).
OF 47 /r	CMOVNBE r16, r/m16	Valid	Valid	Move if not below or equal (CF=0 and ZF=0).
OF 47 /r	CMOVNBE r32, r/m32	Valid	Valid	Move if not below or equal (CF=0 and ZF=0).
REX.W + OF 47 /r	CMOVNBE r64, r/m64	Valid	N.E.	Move if not below or equal (CF=0 and ZF=0).

Opcode	Instruction	64-Bit Mode	Compat/Leg Mode	Description
OF 43 /r	CMOVNC <i>r16, r/m16</i>	Valid	Valid	Move if not carry (CF=0).
OF 43 /r	CMOVNC <i>r32, r/m32</i>	Valid	Valid	Move if not carry (CF=0).
REX.W + OF 43 /r	CMOVNC <i>r64, r/m64</i>	Valid	N.E.	Move if not carry (CF=0).
OF 45 /r	CMOVNE <i>r16, r/m16</i>	Valid	Valid	Move if not equal (ZF=0).
OF 45 /r	CMOVNE <i>r32, r/m32</i>	Valid	Valid	Move if not equal (ZF=0).
REX.W + OF 45 /r	CMOVNE <i>r64, r/m64</i>	Valid	N.E.	Move if not equal (ZF=0).
OF 4E /r	CMOVNG <i>r16, r/m16</i>	Valid	Valid	Move if not greater (ZF=1 or SF≠OF).
OF 4E /r	CMOVNG <i>r32, r/m32</i>	Valid	Valid	Move if not greater (ZF=1 or SF≠OF).
REX.W + OF 4E /r	CMOVNG <i>r64, r/m64</i>	Valid	N.E.	Move if not greater (ZF=1 or SF≠OF).
OF 4C /r	CMOVNGE <i>r16, r/m16</i>	Valid	Valid	Move if not greater or equal (SF≠OF).
OF 4C /r	CMOVNGE <i>r32, r/m32</i>	Valid	Valid	Move if not greater or equal (SF≠OF).
REX.W + OF 4C /r	CMOVNGE <i>r64, r/m64</i>	Valid	N.E.	Move if not greater or equal (SF≠OF).
OF 4D /r	CMOVNL <i>r16, r/m16</i>	Valid	Valid	Move if not less (SF=OF).
OF 4D /r	CMOVNL <i>r32, r/m32</i>	Valid	Valid	Move if not less (SF=OF).
REX.W + OF 4D /r	CMOVNL <i>r64, r/m64</i>	Valid	N.E.	Move if not less (SF=OF).
OF 4F /r	CMOVNLE <i>r16, r/m16</i>	Valid	Valid	Move if not less or equal (ZF=0 and SF=OF).
OF 4F /r	CMOVNLE <i>r32, r/m32</i>	Valid	Valid	Move if not less or equal (ZF=0 and SF=OF).
REX.W + OF 4F /r	CMOVNLE <i>r64, r/m64</i>	Valid	N.E.	Move if not less or equal (ZF=0 and SF=OF).
OF 41 /r	CMOVNO <i>r16, r/m16</i>	Valid	Valid	Move if not overflow (OF=0).
OF 41 /r	CMOVNO <i>r32, r/m32</i>	Valid	Valid	Move if not overflow (OF=0).
REX.W + OF 41 /r	CMOVNO <i>r64, r/m64</i>	Valid	N.E.	Move if not overflow (OF=0).
OF 4B /r	CMOVNP <i>r16, r/m16</i>	Valid	Valid	Move if not parity (PF=0).
OF 4B /r	CMOVNP <i>r32, r/m32</i>	Valid	Valid	Move if not parity (PF=0).

Opcode	Instruction	64-Bit Mode	Compat/ Leg Mode	Description
REX.W + OF 4B /r	CMOVNP <i>r64, r/m64</i>	Valid	N.E.	Move if not parity (PF=0).
OF 49 /r	CMOVNS <i>r16, r/m16</i>	Valid	Valid	Move if not sign (SF=0).
OF 49 /r	CMOVNS <i>r32, r/m32</i>	Valid	Valid	Move if not sign (SF=0).
REX.W + OF 49 /r	CMOVNS <i>r64, r/m64</i>	Valid	N.E.	Move if not sign (SF=0).
OF 45 /r	CMOVNZ <i>r16, r/m16</i>	Valid	Valid	Move if not zero (ZF=0).
OF 45 /r	CMOVNZ <i>r32, r/m32</i>	Valid	Valid	Move if not zero (ZF=0).
REX.W + OF 45 /r	CMOVNZ <i>r64, r/m64</i>	Valid	N.E.	Move if not zero (ZF=0).
OF 40 /r	CMOVO <i>r16, r/m16</i>	Valid	Valid	Move if overflow (OF=0).
OF 40 /r	CMOVO <i>r32, r/m32</i>	Valid	Valid	Move if overflow (OF=0).
REX.W + OF 40 /r	CMOVO <i>r64, r/m64</i>	Valid	N.E.	Move if overflow (OF=0).
OF 4A /r	CMOV P <i>r16, r/m16</i>	Valid	Valid	Move if parity (PF=1).
OF 4A /r	CMOV P <i>r32, r/m32</i>	Valid	Valid	Move if parity (PF=1).
REX.W + OF 4A /r	CMOV P <i>r64, r/m64</i>	Valid	N.E.	Move if parity (PF=1).
OF 4A /r	CMOVPE <i>r16, r/m16</i>	Valid	Valid	Move if parity even (PF=1).
OF 4A /r	CMOVPE <i>r32, r/m32</i>	Valid	Valid	Move if parity even (PF=1).
REX.W + OF 4A /r	CMOVPE <i>r64, r/m64</i>	Valid	N.E.	Move if parity even (PF=1).
OF 4B /r	CMOVPO <i>r16, r/m16</i>	Valid	Valid	Move if parity odd (PF=0).
OF 4B /r	CMOVPO <i>r32, r/m32</i>	Valid	Valid	Move if parity odd (PF=0).
REX.W + OF 4B /r	CMOVPO <i>r64, r/m64</i>	Valid	N.E.	Move if parity odd (PF=0).
OF 48 /r	CMOV S <i>r16, r/m16</i>	Valid	Valid	Move if sign (SF=1).
OF 48 /r	CMOV S <i>r32, r/m32</i>	Valid	Valid	Move if sign (SF=1).
REX.W + OF 48 /r	CMOV S <i>r64, r/m64</i>	Valid	N.E.	Move if sign (SF=1).
OF 44 /r	CMOVZ <i>r16, r/m16</i>	Valid	Valid	Move if zero (ZF=1).
OF 44 /r	CMOVZ <i>r32, r/m32</i>	Valid	Valid	Move if zero (ZF=1).
REX.W + OF 44 /r	CMOVZ <i>r64, r/m64</i>	Valid	N.E.	Move if zero (ZF=1).

Description

The *CMOVcc* instructions check the state of one or more of the status flags in the EFLAGS register (CF, OF, PF, SF, and ZF) and perform a move operation if the flags are in a specified state (or condition). A condition code (*cc*) is associated with each instruction to indicate the condition being tested for. If the condition is not satisfied, a move is not performed and execution continues with the instruction following the *CMOVcc* instruction.

These instructions can move 16-bit, 32-bit or 64-bit values from memory to a general-purpose register or from one general-purpose register to another. Conditional moves of 8-bit register operands are not supported.

The condition for each *CMOVcc* mnemonic is given in the description column of the above table. The terms “less” and “greater” are used for comparisons of signed integers and the terms “above” and “below” are used for unsigned integers.

Because a particular state of the status flags can sometimes be interpreted in two ways, two mnemonics are defined for some opcodes. For example, the *CMOVA* (conditional move if above) instruction and the *CMOVNBE* (conditional move if not below or equal) instruction are alternate mnemonics for the opcode 0F 47H.

The *CMOVcc* instructions were introduced in P6 family processors; however, these instructions may not be supported by all IA-32 processors. Software can determine if the *CMOVcc* instructions are supported by checking the processor’s feature information with the *CPUID* instruction (see “*CPUID—CPU Identification*” in this chapter).

In 64-bit mode, the instruction’s default operation size is 32 bits. Use of the *REX.R* prefix permits access to additional registers (R8-R15). Use of the *REX.W* prefix promotes operation to 64 bits. See the summary chart at the beginning of this section for encoding data and limits.

Operation

temp ← SRC

IF (64-Bit Mode)

 THEN

 IF condition TRUE

 THEN

 IF (OperandSize = 64)

 THEN

 DEST ← temp;

 ELSE

 DEST ← temp AND 0x00000000_FFFFFFFF;

 FI;

 FI;

ELSE

 IF condition TRUE

 THEN

DEST ← temp;

FI;

FI;

Flags Affected

None.

Protected Mode Exceptions

#GP(0)	If a memory operand effective address is outside the CS, DS, ES, FS, or GS segment limit. If the DS, ES, FS, or GS register contains a NULL segment selector.
#SS(0)	If a memory operand effective address is outside the SS segment limit.
#PF(fault-code)	If a page fault occurs.
#AC(0)	If alignment checking is enabled and an unaligned memory reference is made while the current privilege level is 3.
#UD	If the LOCK prefix is used.

Real-Address Mode Exceptions

#GP	If a memory operand effective address is outside the CS, DS, ES, FS, or GS segment limit.
#SS	If a memory operand effective address is outside the SS segment limit.
#UD	If the LOCK prefix is used.

Virtual-8086 Mode Exceptions

#GP(0)	If a memory operand effective address is outside the CS, DS, ES, FS, or GS segment limit.
#SS(0)	If a memory operand effective address is outside the SS segment limit.
#PF(fault-code)	If a page fault occurs.
#AC(0)	If alignment checking is enabled and an unaligned memory reference is made.
#UD	If the LOCK prefix is used.

Compatibility Mode Exceptions

Same exceptions as in protected mode.

64-Bit Mode Exceptions

#SS(0)	If a memory address referencing the SS segment is in a non-canonical form.
#GP(0)	If the memory address is in a non-canonical form.
#PF(fault-code)	If a page fault occurs.
#AC(0)	If alignment checking is enabled and an unaligned memory reference is made while the current privilege level is 3.
#UD	If the LOCK prefix is used.

CMP—Compare Two Operands

Opcode	Instruction	64-Bit Mode	Compat/Leg Mode	Description
3C <i>ib</i>	CMP AL, <i>imm8</i>	Valid	Valid	Compare <i>imm8</i> with AL.
3D <i>iw</i>	CMP AX, <i>imm16</i>	Valid	Valid	Compare <i>imm16</i> with AX.
3D <i>id</i>	CMP EAX, <i>imm32</i>	Valid	Valid	Compare <i>imm32</i> with EAX.
REX.W + 3D <i>id</i>	CMP RAX, <i>imm32</i>	Valid	N.E.	Compare <i>imm32</i> sign-extended to 64-bits with RAX.
80 <i>/7 ib</i>	CMP <i>r/m8</i> , <i>imm8</i>	Valid	Valid	Compare <i>imm8</i> with <i>r/m8</i> .
REX + 80 <i>/7 ib</i>	CMP <i>r/m8</i> [*] , <i>imm8</i>	Valid	N.E.	Compare <i>imm8</i> with <i>r/m8</i> .
81 <i>/7 iw</i>	CMP <i>r/m16</i> , <i>imm16</i>	Valid	Valid	Compare <i>imm16</i> with <i>r/m16</i> .
81 <i>/7 id</i>	CMP <i>r/m32</i> , <i>imm32</i>	Valid	Valid	Compare <i>imm32</i> with <i>r/m32</i> .
REX.W + 81 <i>/7 id</i>	CMP <i>r/m64</i> , <i>imm32</i>	Valid	N.E.	Compare <i>imm32</i> sign-extended to 64-bits with <i>r/m64</i> .
83 <i>/7 ib</i>	CMP <i>r/m16</i> , <i>imm8</i>	Valid	Valid	Compare <i>imm8</i> with <i>r/m16</i> .
83 <i>/7 id</i>	CMP <i>r/m32</i> , <i>imm8</i>	Valid	Valid	Compare <i>imm8</i> with <i>r/m32</i> .
REX.W + 83 <i>/7 ib</i>	CMP <i>r/m64</i> , <i>imm8</i>	Valid	N.E.	Compare <i>imm8</i> with <i>r/m64</i> .
38 <i>/r</i>	CMP <i>r/m8</i> , <i>r8</i>	Valid	Valid	Compare <i>r8</i> with <i>r/m8</i> .
REX + 38 <i>/r</i>	CMP <i>r/m8</i> [*] , <i>r8</i> [*]	Valid	N.E.	Compare <i>r8</i> with <i>r/m8</i> .
39 <i>/r</i>	CMP <i>r/m16</i> , <i>r16</i>	Valid	Valid	Compare <i>r16</i> with <i>r/m16</i> .
39 <i>/r</i>	CMP <i>r/m32</i> , <i>r32</i>	Valid	Valid	Compare <i>r32</i> with <i>r/m32</i> .
REX.W + 39 <i>/r</i>	CMP <i>r/m64</i> , <i>r64</i>	Valid	N.E.	Compare <i>r64</i> with <i>r/m64</i> .
3A <i>/r</i>	CMP <i>r8</i> , <i>r/m8</i>	Valid	Valid	Compare <i>r/m8</i> with <i>r8</i> .
REX + 3A <i>/r</i>	CMP <i>r8</i> [*] , <i>r/m8</i> [*]	Valid	N.E.	Compare <i>r/m8</i> with <i>r8</i> .
3B <i>/r</i>	CMP <i>r16</i> , <i>r/m16</i>	Valid	Valid	Compare <i>r/m16</i> with <i>r16</i> .
3B <i>/r</i>	CMP <i>r32</i> , <i>r/m32</i>	Valid	Valid	Compare <i>r/m32</i> with <i>r32</i> .
REX.W + 3B <i>/r</i>	CMP <i>r64</i> , <i>r/m64</i>	Valid	N.E.	Compare <i>r/m64</i> with <i>r64</i> .

NOTES:

- * In 64-bit mode, *r/m8* can not be encoded to access the following byte registers if a REX prefix is used: AH, BH, CH, DH.

Description

Compares the first source operand with the second source operand and sets the status flags in the EFLAGS register according to the results. The comparison is performed by subtracting the second operand from the first operand and then setting the status flags in the same manner as the SUB instruction. When an immediate value is used as an operand, it is sign-extended to the length of the first operand.

The condition codes used by the *Jcc*, *CMOVcc*, and *SETcc* instructions are based on the results of a CMP instruction. Appendix B, “EFLAGS Condition Codes,” in the *Intel® 64 and IA-32 Architectures Software Developer’s Manual, Volume 1*, shows the relationship of the status flags and the condition codes.

In 64-bit mode, the instruction’s default operation size is 32 bits. Use of the REX.R prefix permits access to additional registers (R8-R15). Use of the REX.W prefix promotes operation to 64 bits. See the summary chart at the beginning of this section for encoding data and limits.

Operation

temp ← SRC1 – SignExtend(SRC2);

ModifyStatusFlags; (* Modify status flags in the same manner as the SUB instruction*)

Flags Affected

The CF, OF, SF, ZF, AF, and PF flags are set according to the result.

Protected Mode Exceptions

#GP(0)	If a memory operand effective address is outside the CS, DS, ES, FS, or GS segment limit. If the DS, ES, FS, or GS register contains a NULL segment selector.
#SS(0)	If a memory operand effective address is outside the SS segment limit.
#PF(fault-code)	If a page fault occurs.
#AC(0)	If alignment checking is enabled and an unaligned memory reference is made while the current privilege level is 3.
#UD	If the LOCK prefix is used.

Real-Address Mode Exceptions

#GP	If a memory operand effective address is outside the CS, DS, ES, FS, or GS segment limit.
#SS	If a memory operand effective address is outside the SS segment limit.

Virtual-8086 Mode Exceptions

#GP(0)	If a memory operand effective address is outside the CS, DS, ES, FS, or GS segment limit.
#SS(0)	If a memory operand effective address is outside the SS segment limit.
#PF(fault-code)	If a page fault occurs.
#AC(0)	If alignment checking is enabled and an unaligned memory reference is made.
#UD	If the LOCK prefix is used.

Compatibility Mode Exceptions

Same exceptions as in protected mode.

64-Bit Mode Exceptions

#SS(0)	If a memory address referencing the SS segment is in a non-canonical form.
#GP(0)	If the memory address is in a non-canonical form.
#PF(fault-code)	If a page fault occurs.
#AC(0)	If alignment checking is enabled and an unaligned memory reference is made while the current privilege level is 3.
#UD	If the LOCK prefix is used.

CMPPD—Compare Packed Double-Precision Floating-Point Values

Opcode	Instruction	64-Bit Mode	Compat/Leg Mode	Description
66 0F C2 /r ib	CMPPD <i>xmm1</i> , <i>xmm2/m128</i> , <i>imm8</i>	Valid	Valid	Compare packed double-precision floating-point values in <i>xmm2/m128</i> and <i>xmm1</i> using <i>imm8</i> as comparison predicate.

Description

Performs a SIMD compare of the two packed double-precision floating-point values in the source operand (second operand) and the destination operand (first operand) and returns the results of the comparison to the destination operand. The comparison predicate operand (third operand) specifies the type of comparison performed on each of the pairs of packed values. The result of each comparison is a quadword mask of all 1s (comparison true) or all 0s (comparison false).

The source operand can be an XMM register or a 128-bit memory location. The destination operand is an XMM register. The comparison predicate operand is an 8-bit immediate, the first 3 bits of which define the type of comparison to be made (see Table 3-15). Bits 3 through 7 of the immediate are reserved.

Table 3-15. Comparison Predicate for CMPPD and CMPPS Instructions

Predicate	imm8 Encoding	Description	Relation where: A Is 1st Operand B Is 2nd Operand	Emulation	Result if NaN Operand	QNaN Operand Signals Invalid
EQ	000B	Equal	$A = B$		False	No
LT	001B	Less-than	$A < B$		False	Yes
LE	010B	Less-than-or-equal	$A \leq B$		False	Yes
		Greater than	$A > B$	Swap Operands, Use LT	False	Yes
		Greater-than-or-equal	$A \geq B$	Swap Operands, Use LE	False	Yes
UNORD	011B	Unordered	$A, B = \text{Unordered}$		True	No
NEQ	100B	Not-equal	$A \neq B$		True	No
NLT	101B	Not-less-than	$\text{NOT}(A < B)$		True	Yes

Table 3-15. Comparison Predicate for CMPPD and CMPPS Instructions (Contd.)

Predicate	imm8 Encoding	Description	Relation where: A Is 1st Operand B Is 2nd Operand	Emulation	Result if NaN Operand	QNaN Operand Signals Invalid
NLE	110B	Not-less-than-or-equal	NOT($A \leq B$)		True	Yes
		Not-greater-than	NOT($A > B$)	Swap Operands, Use NLT	True	Yes
		Not-greater-than-or-equal	NOT($A \geq B$)	Swap Operands, Use NLE	True	Yes
ORD	111B	Ordered	$A, B = \text{Ordered}$		False	No

The unordered relationship is true when at least one of the two source operands being compared is a NaN; the ordered relationship is true when neither source operand is a NaN.

A subsequent computational instruction that uses the mask result in the destination operand as an input operand will not generate an exception, because a mask of all 0s corresponds to a floating-point value of +0.0 and a mask of all 1s corresponds to a QNaN.

Note that the processor does not implement the greater-than, greater-than-or-equal, not-greater-than, and not-greater-than-or-equal relations. These comparisons can be made either by using the inverse relationship (that is, use the “not-less-than-or-equal” to make a “greater-than” comparison) or by using software emulation. When using software emulation, the program must swap the operands (copying registers when necessary to protect the data that will now be in the destination), and then perform the compare using a different predicate. The predicate to be used for these emulations is listed in Table 3-15 under the heading Emulation.

Compilers and assemblers may implement the following two-operand pseudo-ops in addition to the three-operand CMPPD instruction. See Table 3-8.

Table 3-16. Pseudo-Op and CMPPD Implementation

Pseudo-Op	CMPPD Implementation
CMPEQPD <i>xmm1, xmm2</i>	CMPPD <i>xmm1, xmm2, 0</i>
CMPLTPD <i>xmm1, xmm2</i>	CMPPD <i>xmm1, xmm2, 1</i>
CMPLTPD <i>xmm1, xmm2</i>	CMPPD <i>xmm1, xmm2, 2</i>
CMPLTPD <i>xmm1, xmm2</i>	CMPPD <i>xmm1, xmm2, 3</i>
CMPLTPD <i>xmm1, xmm2</i>	CMPPD <i>xmm1, xmm2, 4</i>
CMPLTPD <i>xmm1, xmm2</i>	CMPPD <i>xmm1, xmm2, 5</i>

Table 3-16. Pseudo-Op and CMPPD Implementation

Pseudo-Op	CMPPD Implementation
CMPNLEPD <i>xmm1</i> , <i>xmm2</i>	CMPPD <i>xmm1</i> , <i>xmm2</i> , 6
CMPORDPD <i>xmm1</i> , <i>xmm2</i>	CMPPD <i>xmm1</i> , <i>xmm2</i> , 7

The greater-than relations that the processor does not implement require more than one instruction to emulate in software and therefore should not be implemented as pseudo-ops. (For these, the programmer should reverse the operands of the corresponding less than relations and use move instructions to ensure that the mask is moved to the correct destination register and that the source operand is left intact.)

In 64-bit mode, use of the REX.R prefix permits this instruction to access additional registers (XMM8-XMM15).

Operation

CASE (COMPARISON PREDICATE) OF

0: OP ← EQ;

1: OP ← LT;

2: OP ← LE;

3: OP ← UNORD;

4: OP ← NEQ;

5: OP ← NLT;

6: OP ← NLE;

7: OP ← ORD;

DEFAULT: Reserved;

CMPO ← DEST[63:0] OP SRC[63:0];

CMP1 ← DEST[127:64] OP SRC[127:64];

IF CMPO = TRUE

THEN DEST[63:0] ← FFFFFFFFFFFFFFFFH;

ELSE DEST[63:0] ← 0000000000000000H; FI;

IF CMP1 = TRUE

THEN DEST[127:64] ← FFFFFFFFFFFFFFFFH;

ELSE DEST[127:64] ← 0000000000000000H; FI;

Intel C/C++ Compiler Intrinsic Equivalents

CMPPD for equality `__m128d_mm_cmpeq_pd(__m128d a, __m128d b)`

CMPPD for less-than `__m128d_mm_cmplt_pd(__m128d a, __m128d b)`

CMPPD for less-than-or-equal `__m128d_mm_cmple_pd(__m128d a, __m128d b)`

CMPPD for greater-than `__m128d_mm_cmpgt_pd(__m128d a, __m128d b)`

CMPPD for greater-than-or-equal `__m128d_mm_cmpge_pd(__m128d a, __m128d b)`

CMPPD for inequality	<code>__m128d_mm_cmpneq_pd(__m128d a, __m128d b)</code>
CMPPD for not-less-than	<code>__m128d_mm_cmpnlt_pd(__m128d a, __m128d b)</code>
CMPPD for not-greater-than	<code>__m128d_mm_cmpngt_pd(__m128d a, __m128d b)</code>
CMPPD for not-greater-than-or-equal	<code>__m128d_mm_cmpnge_pd(__m128d a, __m128d b)</code>
CMPPD for ordered	<code>__m128d_mm_cmpord_pd(__m128d a, __m128d b)</code>
CMPPD for unordered	<code>__m128d_mm_cmpunord_pd(__m128d a, __m128d b)</code>
CMPPD for not-less-than-or-equal	<code>__m128d_mm_cmpnle_pd(__m128d a, __m128d b)</code>

SIMD Floating-Point Exceptions

Invalid if SNaN operand and invalid if QNaN and predicate as listed in above table, Denormal.

Protected Mode Exceptions

#GP(0)	For an illegal memory operand effective address in the CS, DS, ES, FS or GS segments. If a memory operand is not aligned on a 16-byte boundary, regardless of segment.
#SS(0)	For an illegal address in the SS segment.
#PF(fault-code)	For a page fault.
#NM	If CR0.TS[bit 3] = 1.
#XM	If an unmasked SIMD floating-point exception and CR4.OSXMMEXCPT[bit 10] = 1.
#UD	If an unmasked SIMD floating-point exception and CR4.OSXMMEXCPT[bit 10] = 0. If CR0.EM[bit 2] = 1. If CR4.OSFXSR[bit 9] = 0. If CPUID.01H:EDX.SSE2[bit 26] = 0. If the LOCK prefix is used.

Real-Address Mode Exceptions

#GP	If a memory operand is not aligned on a 16-byte boundary, regardless of segment. If any part of the operand lies outside the effective address space from 0 to FFFFH.
#NM	If CR0.TS[bit 3] = 1.
#XM	If an unmasked SIMD floating-point exception and CR4.OSXMMEXCPT[bit 10] = 1.

#UD	<p>If an unmasked SIMD floating-point exception and CR4.OSXMMEXCPT[bit 10] = 0.</p> <p>If CR0.EM[bit 2] = 1.</p> <p>If CR4.OSFXSR[bit 9] = 0.</p> <p>If CPUID.01H:EDX.SSE2[bit 26] = 0.</p> <p>If the LOCK prefix is used.</p>
-----	--------------------------------------------------------------------------------------------------------------------------------------------------------------------------------------------------------------------------------

Virtual-8086 Mode Exceptions

Same exceptions as in real address mode.

#PF(fault-code) For a page fault.

Compatibility Mode Exceptions

Same exceptions as in protected mode.

64-Bit Mode Exceptions

#SS(0)	If a memory address referencing the SS segment is in a non-canonical form.
#GP(0)	<p>If the memory address is in a non-canonical form.</p> <p>If memory operand is not aligned on a 16-byte boundary, regardless of segment.</p>
#PF(fault-code)	For a page fault.
#NM	If CR0.TS[bit 3] = 1.
#XM	If an unmasked SIMD floating-point exception and CR4.OSXMMEXCPT[bit 10] = 1.
#UD	<p>If an unmasked SIMD floating-point exception and CR4.OSXMMEXCPT[bit 10] = 0.</p> <p>If CR0.EM[bit 2] = 1.</p> <p>If CR4.OSFXSR[bit 9] = 0.</p> <p>If CPUID.01H:EDX.SSE2[bit 26] = 0.</p> <p>If the LOCK prefix is used.</p>

CMPPS—Compare Packed Single-Precision Floating-Point Values

Opcode	Instruction	64-Bit Mode	Compat/ Leg Mode	Description
OF C2 /rib	CMPPS <i>xmm1</i> , <i>xmm2/m128</i> , <i>imm8</i>	Valid	Valid	Compare packed single-precision floating-point values in <i>xmm2/mem</i> and <i>xmm1</i> using <i>imm8</i> as comparison predicate.

Description

Performs a SIMD compare of the four packed single-precision floating-point values in the source operand (second operand) and the destination operand (first operand) and returns the results of the comparison to the destination operand. The comparison predicate operand (third operand) specifies the type of comparison performed on each of the pairs of packed values. The result of each comparison is a doubleword mask of all 1s (comparison true) or all 0s (comparison false).

The source operand can be an XMM register or a 128-bit memory location. The destination operand is an XMM register. The comparison predicate operand is an 8-bit immediate, the first 3 bits of which define the type of comparison to be made (see Table 3-15). Bits 3 through 7 of the immediate are reserved.

The unordered relationship is true when at least one of the two source operands being compared is a NaN; the ordered relationship is true when neither source operand is a NaN.

A subsequent computational instruction that uses the mask result in the destination operand as an input operand will not generate a fault, because a mask of all 0s corresponds to a floating-point value of +0.0 and a mask of all 1s corresponds to a QNaN.

Some of the comparisons listed in Table 3-15 (such as the greater-than, greater-than-or-equal, not-greater-than, and not-greater-than-or-equal relations) can be made only through software emulation. For these comparisons the program must swap the operands (copying registers when necessary to protect the data that will now be in the destination), and then perform the compare using a different predicate. The predicate to be used for these emulations is listed in Table 3-15 under the heading Emulation.

Compilers and assemblers may implement the following two-operand pseudo-ops in addition to the three-operand CMPPS instruction. See Table 3-17.

In 64-bit mode, use of the REX.R prefix permits this instruction to access additional registers (XMM8-XMM15).

Table 3-17. Pseudo-Ops and CMPPS

Pseudo-Op	Implementation
CMPEQPS <i>xmm1, xmm2</i>	CMPPS <i>xmm1, xmm2, 0</i>
CMPLTPS <i>xmm1, xmm2</i>	CMPPS <i>xmm1, xmm2, 1</i>
CMPLTPS <i>xmm1, xmm2</i>	CMPPS <i>xmm1, xmm2, 2</i>
CMPUNORDPS <i>xmm1, xmm2</i>	CMPPS <i>xmm1, xmm2, 3</i>
CMPNEQPS <i>xmm1, xmm2</i>	CMPPS <i>xmm1, xmm2, 4</i>
CMPNLTPS <i>xmm1, xmm2</i>	CMPPS <i>xmm1, xmm2, 5</i>
CMPNLEPS <i>xmm1, xmm2</i>	CMPPS <i>xmm1, xmm2, 6</i>
CMPORDPS <i>xmm1, xmm2</i>	CMPPS <i>xmm1, xmm2, 7</i>

The greater-than relations not implemented by the processor require more than one instruction to emulate in software and therefore should not be implemented as pseudo-ops. (For these, the programmer should reverse the operands of the corresponding less than relations and use move instructions to ensure that the mask is moved to the correct destination register and that the source operand is left intact.)

Operation

CASE (COMPARISON PREDICATE) OF

- 0: OP ← EQ;
- 1: OP ← LT;
- 2: OP ← LE;
- 3: OP ← UNORD;
- 4: OP ← NE;
- 5: OP ← NLT;
- 6: OP ← NLE;
- 7: OP ← ORD;

EASC;

CMPO ← DEST[31:0] OP SRC[31:0];
 CMP1 ← DEST[63:32] OP SRC[63:32];
 CMP2 ← DEST [95:64] OP SRC[95:64];
 CMP3 ← DEST[127:96] OP SRC[127:96];

IF CMPO = TRUE

THEN DEST[31:0] ← FFFFFFFFH;
 ELSE DEST[31:0] ← 00000000H; FI;

IF CMP1 = TRUE

THEN DEST[63:32] ← FFFFFFFFH;
 ELSE DEST[63:32] ← 00000000H; FI;

IF CMP2 = TRUE

```

THEN DEST95:64] ← FFFFFFFFH;
ELSE DEST[95:64] ← 00000000H; FI;
IF CMP3 = TRUE
  THEN DEST[127:96] ← FFFFFFFFH;
  ELSE DEST[127:96] ← 00000000H; FI;

```

Intel C/C++ Compiler Intrinsic Equivalents

CMPPS for equality	<code>__m128 _mm_cmpeq_ps(__m128 a, __m128 b)</code>
CMPPS for less-than	<code>__m128 _mm_cmlt_ps(__m128 a, __m128 b)</code>
CMPPS for less-than-or-equal	<code>__m128 _mm_cmple_ps(__m128 a, __m128 b)</code>
CMPPS for greater-than	<code>__m128 _mm_cmpgt_ps(__m128 a, __m128 b)</code>
CMPPS for greater-than-or-equal	<code>__m128 _mm_cmpge_ps(__m128 a, __m128 b)</code>
CMPPS for inequality	<code>__m128 _mm_cmpneq_ps(__m128 a, __m128 b)</code>
CMPPS for not-less-than	<code>__m128 _mm_cmpnlt_ps(__m128 a, __m128 b)</code>
CMPPS for not-greater-than	<code>__m128 _mm_cmpngt_ps(__m128 a, __m128 b)</code>
CMPPS for not-greater-than-or-equal	<code>__m128 _mm_cmpnge_ps(__m128 a, __m128 b)</code>
CMPPS for ordered	<code>__m128 _mm_cmpord_ps(__m128 a, __m128 b)</code>
CMPPS for unordered	<code>__m128 _mm_cmpunord_ps(__m128 a, __m128 b)</code>
CMPPS for not-less-than-or-equal	<code>__m128 _mm_cmpnle_ps(__m128 a, __m128 b)</code>

SIMD Floating-Point Exceptions

Invalid if SNaN operand and invalid if QNaN and predicate as listed in above table, Denormal.

Protected Mode Exceptions

#GP(0)	For an illegal memory operand effective address in the CS, DS, ES, FS or GS segments. If a memory operand is not aligned on a 16-byte boundary, regardless of segment.
#SS(0)	For an illegal address in the SS segment.
#PF(fault-code)	For a page fault.
#NM	If CR0.TS[bit 3] = 1.
#XM	If an unmasked SIMD floating-point exception and CR4.OSXMMEXCPT[bit 10] = 1.
#UD	If an unmasked SIMD floating-point exception and CR4.OSXMMEXCPT[bit 10] = 0. If CR0.EM[bit 2] = 1. If CR4.OSFXSR[bit 9] = 0.

If CPUID.01H: EDX.SSE[bit 25] = 0.
If the LOCK prefix is used.

Real-Address Mode Exceptions

#GP	If a memory operand is not aligned on a 16-byte boundary, regardless of segment. If any part of the operand lies outside the effective address space from 0 to FFFFH.
#NM	If CR0.TS[bit 3] = 1.
#XM	If an unmasked SIMD floating-point exception and CR4.OSXMMEXCPT[bit 10] = 1.
#UD	If an unmasked SIMD floating-point exception and CR4.OSXMMEXCPT[bit 10] = 0. If CR0.EM[bit 2] = 1. If CR4.OSFXSR[bit 9] = 0. If CPUID.01H: EDX.SSE[bit 25] = 0. If the LOCK prefix is used.

Virtual-8086 Mode Exceptions

Same exceptions as in real address mode.

#PF(fault-code) For a page fault.

Compatibility Mode Exceptions

Same exceptions as in protected mode.

64-Bit Mode Exceptions

#SS(0)	If a memory address referencing the SS segment is in a non-canonical form.
#GP(0)	If the memory address is in a non-canonical form. If memory operand is not aligned on a 16-byte boundary, regardless of segment.
#PF(fault-code)	For a page fault.
#NM	If CR0.TS[bit 3] = 1.
#XM	If an unmasked SIMD floating-point exception and CR4.OSXMMEXCPT[bit 10] = 1.

#UD

If an unmasked SIMD floating-point exception and CR4.OSXMMEXCPT[bit 10] = 0.

If CR0.EM[bit 2] = 1.

If CR4.OSFXSR[bit 9] = 0.

If CPUID.01H:EDX.SSE[bit 25] = 0.

If the LOCK prefix is used.

CMPS/CMPSB/CMPSW/CMPSD/CMPSQ—Compare String Operands

Opcode	Instruction	64-Bit Mode	Compat/ Leg Mode	Description
A6	CMPS <i>m8, m8</i>	Valid	Valid	For legacy mode, compare byte at address DS:(E)SI with byte at address ES:(E)DI; For 64-bit mode compare byte at address (R)ESI to byte at address (R)EDI. The status flags are set accordingly.
A7	CMPS <i>m16, m16</i>	Valid	Valid	For legacy mode, compare word at address DS:(E)SI with word at address ES:(E)DI; For 64-bit mode compare word at address (R)ESI with word at address (R)EDI. The status flags are set accordingly.
A7	CMPS <i>m32, m32</i>	Valid	Valid	For legacy mode, compare dword at address DS:(E)SI at dword at address ES:(E)DI; For 64-bit mode compare dword at address (R)ESI at dword at address (R)EDI. The status flags are set accordingly.
REX.W + A7	CMPS <i>m64, m64</i>	Valid	N.E.	Compares quadword at address (R)ESI with quadword at address (R)EDI and sets the status flags accordingly.
A6	CMPSB	Valid	Valid	For legacy mode, compare byte at address DS:(E)SI with byte at address ES:(E)DI; For 64-bit mode compare byte at address (R)ESI with byte at address (R)EDI. The status flags are set accordingly.

Opcode	Instruction	64-Bit Mode	Compat/Leg Mode	Description
A7	CMPSW	Valid	Valid	For legacy mode, compare word at address DS:(E)SI with word at address ES:(E)DI; For 64-bit mode compare word at address (R)ESI with word at address (R)EDI. The status flags are set accordingly.
A7	CMPSD	Valid	Valid	For legacy mode, compare dword at address DS:(E)SI with dword at address ES:(E)DI; For 64-bit mode compare dword at address (R)ESI with dword at address (R)EDI. The status flags are set accordingly.
REX.W + A7	CMPSQ	Valid	N.E.	Compares quadword at address (R)ESI with quadword at address (R)EDI and sets the status flags accordingly.

Description

Compares the byte, word, doubleword, or quadword specified with the first source operand with the byte, word, doubleword, or quadword specified with the second source operand and sets the status flags in the EFLAGS register according to the results.

Both source operands are located in memory. The address of the first source operand is read from DS:SI, DS:ESI or RSI (depending on the address-size attribute of the instruction is 16, 32, or 64, respectively). The address of the second source operand is read from ES:DI, ES:EDI or RDI (again depending on the address-size attribute of the instruction is 16, 32, or 64). The DS segment may be overridden with a segment override prefix, but the ES segment cannot be overridden.

At the assembly-code level, two forms of this instruction are allowed: the “explicit-operands” form and the “no-operands” form. The explicit-operands form (specified with the CMPS mnemonic) allows the two source operands to be specified explicitly. Here, the source operands should be symbols that indicate the size and location of the source values. This explicit-operand form is provided to allow documentation. However, note that the documentation provided by this form can be misleading. That is, the source operand symbols must specify the correct type (size) of the operands (bytes, words, or doublewords, quadwords), but they do not have to specify the correct location. Locations of the source operands are always specified by the DS:(E)SI (or RSI) and ES:(E)DI (or RDI) registers, which must be loaded correctly before the compare string instruction is executed.

The no-operands form provides “short forms” of the byte, word, and doubleword versions of the CMPS instructions. Here also the DS:(E)SI (or RSI) and ES:(E)DI (or

RDI) registers are assumed by the processor to specify the location of the source operands. The size of the source operands is selected with the mnemonic: CMPSB (byte comparison), CMPSW (word comparison), CMPSD (doubleword comparison), or CMPSQ (quadword comparison using REX.W).

After the comparison, the (E/R)SI and (E/R)DI registers increment or decrement automatically according to the setting of the DF flag in the EFLAGS register. (If the DF flag is 0, the (E/R)SI and (E/R)DI register increment; if the DF flag is 1, the registers decrement.) The registers increment or decrement by 1 for byte operations, by 2 for word operations, 4 for doubleword operations. If operand size is 64, RSI and RDI registers increment by 8 for quadword operations.

The CMPS, CMPSB, CMPSW, CMPSD, and CMPSQ instructions can be preceded by the REP prefix for block comparisons. More often, however, these instructions will be used in a LOOP construct that takes some action based on the setting of the status flags before the next comparison is made. See “RDTSCP—Read Time-Stamp Counter and Processor ID” in Chapter 4, in the *Intel® 64 and IA-32 Architectures Software Developer’s Manual, Volume 2B*, for a description of the REP prefix.

In 64-bit mode, the instruction’s default address size is 64 bits, 32 bit address size is supported using the prefix 67H. Use of the REX.W prefix promotes doubleword operation to 64 bits (see CMPSQ). See the summary chart at the beginning of this section for encoding data and limits.

Operation

```
temp SRC1 - SRC2;
setStatusFlags(temp);
```

```
IF (64-Bit Mode)
  THEN
    IF (Byte comparison)
      THEN IF DF = 0
        THEN
          (R|E)SI ← (R|E)SI + 1;
          (R|E)DI ← (R|E)DI + 1;
        ELSE
          (R|E)SI ← (R|E)SI - 1;
          (R|E)DI ← (R|E)DI - 1;
        FI;
      ELSE IF (Word comparison)
        THEN IF DF = 0
          THEN
            (R|E)SI ← (R|E)SI + 2;
            (R|E)DI ← (R|E)DI + 2;
          ELSE
            (R|E)SI ← (R|E)SI - 2;
```

```

        (R|E)DI ← (R|E)DI - 2;
    FI;
ELSE IF (Doubleword comparison)
    THEN IF DF = 0
        THEN
            (R|E)SI ← (R|E)SI + 4;
            (R|E)DI ← (R|E)DI + 4;
        ELSE
            (R|E)SI ← (R|E)SI - 4;
            (R|E)DI ← (R|E)DI - 4;
        FI;
ELSE (* Quadword comparison *)
    THEN IF DF = 0
        (R|E)SI ← (R|E)SI + 8;
        (R|E)DI ← (R|E)DI + 8;
    ELSE
        (R|E)SI ← (R|E)SI - 8;
        (R|E)DI ← (R|E)DI - 8;
    FI;
FI;
ELSE (* Non-64-bit Mode *)
    IF (byte comparison)
        THEN IF DF = 0
            THEN
                (E)SI ← (E)SI + 1;
                (E)DI ← (E)DI + 1;
            ELSE
                (E)SI ← (E)SI - 1;
                (E)DI ← (E)DI - 1;
            FI;
        ELSE IF (Word comparison)
            THEN IF DF = 0
                (E)SI ← (E)SI + 2;
                (E)DI ← (E)DI + 2;
            ELSE
                (E)SI ← (E)SI - 2;
                (E)DI ← (E)DI - 2;
            FI;
        ELSE (* Doubleword comparison *)
            THEN IF DF = 0
                (E)SI ← (E)SI + 4;
                (E)DI ← (E)DI + 4;
            ELSE

```

$$(E)SI \leftarrow (E)SI - 4;$$

$$(E)DI \leftarrow (E)DI - 4;$$

FI;

FI;

FI;

Flags Affected

The CF, OF, SF, ZF, AF, and PF flags are set according to the temporary result of the comparison.

Protected Mode Exceptions

#GP(0)	If a memory operand effective address is outside the CS, DS, ES, FS, or GS segment limit. If the DS, ES, FS, or GS register contains a NULL segment selector.
#SS(0)	If a memory operand effective address is outside the SS segment limit.
#PF(fault-code)	If a page fault occurs.
#AC(0)	If alignment checking is enabled and an unaligned memory reference is made while the current privilege level is 3.
#UD	If the LOCK prefix is used.

Real-Address Mode Exceptions

#GP	If a memory operand effective address is outside the CS, DS, ES, FS, or GS segment limit.
#SS	If a memory operand effective address is outside the SS segment limit.
#UD	If the LOCK prefix is used.

Virtual-8086 Mode Exceptions

#GP(0)	If a memory operand effective address is outside the CS, DS, ES, FS, or GS segment limit.
#SS(0)	If a memory operand effective address is outside the SS segment limit.
#PF(fault-code)	If a page fault occurs.
#AC(0)	If alignment checking is enabled and an unaligned memory reference is made.
#UD	If the LOCK prefix is used.

Compatibility Mode Exceptions

Same exceptions as in protected mode.

64-Bit Mode Exceptions

#SS(0)	If a memory address referencing the SS segment is in a non-canonical form.
#GP(0)	If the memory address is in a non-canonical form.
#PF(fault-code)	If a page fault occurs.
#AC(0)	If alignment checking is enabled and an unaligned memory reference is made while the current privilege level is 3.
#UD	If the LOCK prefix is used.

CMPSD—Compare Scalar Double-Precision Floating-Point Values

Opcode	Instruction	64-Bit Mode	Compat/ Leg Mode	Description
F2 0F C2 /r ib	CMPSD <i>xmm1</i> , <i>xmm2/m64</i> , <i>imm8</i>	Valid	Valid	Compare low double-precision floating-point value in <i>xmm2/m64</i> and <i>xmm1</i> using <i>imm8</i> as comparison predicate.

Description

Compares the low double-precision floating-point values in the source operand (second operand) and the destination operand (first operand) and returns the results of the comparison to the destination operand. The comparison predicate operand (third operand) specifies the type of comparison performed. The comparison result is a quadword mask of all 1s (comparison true) or all 0s (comparison false).

The source operand can be an XMM register or a 64-bit memory location. The destination operand is an XMM register. The result is stored in the low quadword of the destination operand; the high quadword remains unchanged. The comparison predicate operand is an 8-bit immediate, the first 3 bits of which define the type of comparison to be made (see Table 3-15). Bits 3 through 7 of the immediate are reserved.

The unordered relationship is true when at least one of the two source operands being compared is a NaN; the ordered relationship is true when neither source operand is a NaN.

A subsequent computational instruction that uses the mask result in the destination operand as an input operand will not generate a fault, because a mask of all 0s corresponds to a floating-point value of +0.0 and a mask of all 1s corresponds to a QNaN.

Some of the comparisons listed in Table 3-15 can be achieved only through software emulation. For these comparisons the program must swap the operands (copying registers when necessary to protect the data that will now be in the destination operand), and then perform the compare using a different predicate. The predicate to be used for these emulations is listed in Table 3-15 under the heading Emulation.

Compilers and assemblers may implement the following two-operand pseudo-ops in addition to the three-operand CMPSD instruction. See Table 3-18.

Table 3-18. Pseudo-Ops and CMPSD

Pseudo-Op	Implementation
CMPEQSD <i>xmm1</i> , <i>xmm2</i>	CMPSD <i>xmm1</i> , <i>xmm2</i> , 0
CMPLTSD <i>xmm1</i> , <i>xmm2</i>	CMPSD <i>xmm1</i> , <i>xmm2</i> , 1
CMPLESD <i>xmm1</i> , <i>xmm2</i>	CMPSD <i>xmm1</i> , <i>xmm2</i> , 2

Table 3-18. Pseudo-Ops and CMPSD (Contd.)

Pseudo-Op	Implementation
CMPUNORDSD <i>xmm1, xmm2</i>	CMPSD <i>xmm1,xmm2, 3</i>
CMPNEQSD <i>xmm1, xmm2</i>	CMPSD <i>xmm1,xmm2, 4</i>
CMPNLTSD <i>xmm1, xmm2</i>	CMPSD <i>xmm1,xmm2, 5</i>
CMPNLESD <i>xmm1, xmm2</i>	CMPSD <i>xmm1,xmm2, 6</i>
CMPORDSD <i>xmm1, xmm2</i>	CMPSD <i>xmm1,xmm2, 7</i>

The greater-than relations not implemented in the processor require more than one instruction to emulate in software and therefore should not be implemented as pseudo-ops. (For these, the programmer should reverse the operands of the corresponding less than relations and use move instructions to ensure that the mask is moved to the correct destination register and that the source operand is left intact.)

In 64-bit mode, use of the REX.R prefix permits this instruction to access additional registers (XMM8-XMM15).

Operation

CASE (COMPARISON PREDICATE) OF

- 0: OP ← EQ;
 - 1: OP ← LT;
 - 2: OP ← LE;
 - 3: OP ← UNORD;
 - 4: OP ← NEQ;
 - 5: OP ← NLT;
 - 6: OP ← NLE;
 - 7: OP ← ORD;
- DEFAULT: Reserved;

CMPO ← DEST[63:0] OP SRC[63:0];

IF CMPO = TRUE

- THEN DEST[63:0] ← FFFFFFFFFFFFFFFFH;
- ELSE DEST[63:0] ← 0000000000000000H; FI;

(* DEST[127:64] unchanged *)

Intel C/C++ Compiler Intrinsic Equivalents

CMPSD for equality `__m128d _mm_cmpeq_sd(__m128d a, __m128d b)`

CMPSD for less-than `__m128d _mm_cmlt_sd(__m128d a, __m128d b)`

CMPSD for less-than-or-equal `__m128d _mm_cmple_sd(__m128d a, __m128d b)`

CMPSD for greater-than `__m128d _mm_cmpgt_sd(__m128d a, __m128d b)`

CMPSD for greater-than-or-equal	<code>__m128d_mm_cmpge_sd(__m128d a, __m128d b)</code>
CMPSD for inequality	<code>__m128d_mm_cmpneq_sd(__m128d a, __m128d b)</code>
CMPSD for not-less-than	<code>__m128d_mm_cmpnlt_sd(__m128d a, __m128d b)</code>
CMPSD for not-greater-than	<code>__m128d_mm_cmpngt_sd(__m128d a, __m128d b)</code>
CMPSD for not-greater-than-or-equal	<code>__m128d_mm_cmpnge_sd(__m128d a, __m128d b)</code>
CMPSD for ordered	<code>__m128d_mm_cmpord_sd(__m128d a, __m128d b)</code>
CMPSD for unordered	<code>__m128d_mm_cmpunord_sd(__m128d a, __m128d b)</code>
CMPSD for not-less-than-or-equal	<code>__m128d_mm_cmpnle_sd(__m128d a, __m128d b)</code>

SIMD Floating-Point Exceptions

Invalid if SNaN operand, Invalid if QNaN and predicate as listed in above table, Denormal.

Protected Mode Exceptions

#GP(0)	For an illegal memory operand effective address in the CS, DS, ES, FS or GS segments.
#SS(0)	For an illegal address in the SS segment.
#PF(fault-code)	For a page fault.
#NM	If CR0.TS[bit 3] = 1.
#XM	If an unmasked SIMD floating-point exception and CR4.OSXMMEXCPT[bit 10] = 1.
#UD	If an unmasked SIMD floating-point exception and CR4.OSXMMEXCPT[bit 10] = 0. If CR0.EM[bit 2] = 1. If CR4.OSFXSR[bit 9] = 0. If CPUID.01H:EDX.SSE2[bit 26] = 0.
#UD	If the LOCK prefix is used.
#AC(0)	If alignment checking is enabled and an unaligned memory reference is made while the current privilege level is 3.

Real-Address Mode Exceptions

#GP	If any part of the operand lies outside the effective address space from 0 to FFFFH.
#NM	If CR0.TS[bit 3] = 1.
#XM	If an unmasked SIMD floating-point exception and CR4.OSXMMEXCPT[bit 10] = 1.
#UD	If an unmasked SIMD floating-point exception and CR4.OSXMMEXCPT[bit 10] = 0. If CR0.EM[bit 2] = 1.

If CR4.OSFXSR[bit 9] = 0.
 If CPUID.01H:EDX.SSE2[bit 26] = 0.
 If the LOCK prefix is used.

Virtual-8086 Mode Exceptions

Same exceptions as in real address mode.

#PF(fault-code) For a page fault.
 #AC(0) If alignment checking is enabled and an unaligned memory reference is made.

Compatibility Mode Exceptions

Same exceptions as in protected mode.

64-Bit Mode Exceptions

#SS(0) If a memory address referencing the SS segment is in a non-canonical form.
 #GP(0) If the memory address is in a non-canonical form.
 #PF(fault-code) For a page fault.
 #NM If CR0.TS[bit 3] = 1.
 #XM If an unmasked SIMD floating-point exception and CR4.OSXMMEXCPT[bit 10] = 1.
 #UD If an unmasked SIMD floating-point exception and CR4.OSXMMEXCPT[bit 10] = 0.
 If CR0.EM[bit 2] = 1.
 If CR4.OSFXSR[bit 9] = 0.
 If CPUID.01H:EDX.SSE2[bit 26] = 0.
 If the LOCK prefix is used.
 #AC(0) If alignment checking is enabled and an unaligned memory reference is made while the current privilege level is 3.

CMPSS—Compare Scalar Single-Precision Floating-Point Values

Opcode	Instruction	64-Bit Mode	Compat/ Leg Mode	Description
F3 0F C2 /r ib	CMPSS <i>xmm1</i> , <i>xmm2/m32</i> , <i>imm8</i>	Valid	Valid	Compare low single-precision floating-point value in <i>xmm2/m32</i> and <i>xmm1</i> using <i>imm8</i> as comparison predicate.

Description

Compares the low single-precision floating-point values in the source operand (second operand) and the destination operand (first operand) and returns the results of the comparison to the destination operand. The comparison predicate operand (third operand) specifies the type of comparison performed. The comparison result is a doubleword mask of all 1s (comparison true) or all 0s (comparison false).

The source operand can be an XMM register or a 32-bit memory location. The destination operand is an XMM register. The result is stored in the low doubleword of the destination operand; the 3 high-order doublewords remain unchanged. The comparison predicate operand is an 8-bit immediate, the first 3 bits of which define the type of comparison to be made (see Table 3-15). Bits 3 through 7 of the immediate are reserved.

The unordered relationship is true when at least one of the two source operands being compared is a NaN; the ordered relationship is true when neither source operand is a NaN.

A subsequent computational instruction that uses the mask result in the destination operand as an input operand will not generate a fault, since a mask of all 0s corresponds to a floating-point value of +0.0 and a mask of all 1s corresponds to a QNaN.

Some of the comparisons listed in Table 3-15 can be achieved only through software emulation. For these comparisons the program must swap the operands (copying registers when necessary to protect the data that will now be in the destination operand), and then perform the compare using a different predicate. The predicate to be used for these emulations is listed in Table 3-15 under the heading Emulation.

Compilers and assemblers may implement the following two-operand pseudo-ops in addition to the three-operand CMPSS instruction. See Table 3-19.

Table 3-19. Pseudo-Ops and CMPSS

Pseudo-Op	CMPSS Implementation
CMPEQSS <i>xmm1, xmm2</i>	CMPSS <i>xmm1, xmm2, 0</i>
CMPLTSS <i>xmm1, xmm2</i>	CMPSS <i>xmm1, xmm2, 1</i>
CMPLESS <i>xmm1, xmm2</i>	CMPSS <i>xmm1, xmm2, 2</i>
CMPUNORDSS <i>xmm1, xmm2</i>	CMPSS <i>xmm1, xmm2, 3</i>
CMPNEQSS <i>xmm1, xmm2</i>	CMPSS <i>xmm1, xmm2, 4</i>
CMPNLTSS <i>xmm1, xmm2</i>	CMPSS <i>xmm1, xmm2, 5</i>
CMPNLESS <i>xmm1, xmm2</i>	CMPSS <i>xmm1, xmm2, 6</i>
CMPORDSS <i>xmm1, xmm2</i>	CMPSS <i>xmm1, xmm2, 7</i>

The greater-than relations not implemented in the processor require more than one instruction to emulate in software and therefore should not be implemented as pseudo-ops. (For these, the programmer should reverse the operands of the corresponding less than relations and use move instructions to ensure that the mask is moved to the correct destination register and that the source operand is left intact.)

In 64-bit mode, use of the REX.R prefix permits this instruction to access additional registers (XMM8-XMM15).

Operation

CASE (COMPARISON PREDICATE) OF

- 0: OP ← EQ;
 - 1: OP ← LT;
 - 2: OP ← LE;
 - 3: OP ← UNORD;
 - 4: OP ← NEQ;
 - 5: OP ← NLT;
 - 6: OP ← NLE;
 - 7: OP ← ORD;
- DEFAULT: Reserved;

CMPO ← DEST[31:0] OP SRC[31:0];

IF CMPO = TRUE

THEN DEST[31:0] ← FFFFFFFFH;
 ELSE DEST[31:0] ← 00000000H; FI;

(* DEST[127:32] unchanged *)

Intel C/C++ Compiler Intrinsic Equivalents

CMPSS for equality `__m128 _mm_cmpeq_ss(__m128 a, __m128 b)`

CMPSS for less-than	<code>__m128_mm_cmplt_ss(__m128 a, __m128 b)</code>
CMPSS for less-than-or-equal	<code>__m128_mm_cmple_ss(__m128 a, __m128 b)</code>
CMPSS for greater-than	<code>__m128_mm_cmpgt_ss(__m128 a, __m128 b)</code>
CMPSS for greater-than-or-equal	<code>__m128_mm_cmpge_ss(__m128 a, __m128 b)</code>
CMPSS for inequality	<code>__m128_mm_cmpneq_ss(__m128 a, __m128 b)</code>
CMPSS for not-less-than	<code>__m128_mm_cmpnlt_ss(__m128 a, __m128 b)</code>
CMPSS for not-greater-than	<code>__m128_mm_cmpngt_ss(__m128 a, __m128 b)</code>
CMPSS for not-greater-than-or-equal	<code>__m128_mm_cmpnge_ss(__m128 a, __m128 b)</code>
CMPSS for ordered	<code>__m128_mm_cmpord_ss(__m128 a, __m128 b)</code>
CMPSS for unordered	<code>__m128_mm_cmpunord_ss(__m128 a, __m128 b)</code>
CMPSS for not-less-than-or-equal	<code>__m128_mm_cmpnle_ss(__m128 a, __m128 b)</code>

SIMD Floating-Point Exceptions

Invalid if SNaN operand, Invalid if QNaN and predicate as listed in above table, Denormal.

Protected Mode Exceptions

#GP(0)	For an illegal memory operand effective address in the CS, DS, ES, FS or GS segments.
#SS(0)	For an illegal address in the SS segment.
#PF(fault-code)	For a page fault.
#NM	If <code>CRO.TS[bit 3] = 1</code> .
#XM	If an unmasked SIMD floating-point exception and <code>CR4.OSXMMEXCPT[bit 10] = 1</code> .
#UD	If an unmasked SIMD floating-point exception and <code>CR4.OSXMMEXCPT[bit 10] = 0</code> . If <code>CRO.EM[bit 2] = 1</code> . If <code>CR4.OSFXSR[bit 9] = 0</code> . If <code>CPUID.01H:EDX.SSE[bit 25] = 0</code> .
#UD	If the LOCK prefix is used.
#AC(0)	If alignment checking is enabled and an unaligned memory reference is made while the current privilege level is 3.

Real-Address Mode Exceptions

#GP	If any part of the operand lies outside the effective address space from 0 to FFFFH.
#NM	If <code>CRO.TS[bit 3] = 1</code> .
#XM	If an unmasked SIMD floating-point exception and <code>CR4.OSXMMEXCPT[bit 10] = 1</code> .

#UD	<p>If an unmasked SIMD floating-point exception and CR4.OSXMMEXCPT[bit 10] = 0.</p> <p>If CR0.EM[bit 2] = 1.</p> <p>If CR4.OSFXSR[bit 9] = 0.</p> <p>If CPUID.01H:EDX.SSE[bit 25] = 0.</p> <p>If the LOCK prefix is used.</p>
-----	-------------------------------------------------------------------------------------------------------------------------------------------------------------------------------------------------------------------------------

Virtual-8086 Mode Exceptions

Same exceptions as in real address mode.

#PF(fault-code)	For a page fault.
#AC(0)	If alignment checking is enabled and an unaligned memory reference is made.

64-Bit Mode Exceptions

#SS(0)	If a memory address referencing the SS segment is in a non-canonical form.
#GP(0)	If the memory address is in a non-canonical form.
#PF(fault-code)	For a page fault.
#NM	If CR0.TS[bit 3] = 1.
#XM	If an unmasked SIMD floating-point exception and CR4.OSXMMEXCPT[bit 10] = 1.
#UD	<p>If an unmasked SIMD floating-point exception and CR4.OSXMMEXCPT[bit 10] = 0.</p> <p>If CR0.EM[bit 2] = 1.</p> <p>If CR4.OSFXSR[bit 9] = 0.</p> <p>If CPUID.01H:EDX.SSE[bit 25] = 0.</p> <p>If the LOCK prefix is used.</p>
#AC(0)	If alignment checking is enabled and an unaligned memory reference is made while the current privilege level is 3.

CMPXCHG—Compare and Exchange

Opcode	Instruction	64-Bit Mode	Compat/Leg Mode	Description
OF B0/ <i>r</i>	CMPXCHG <i>r/m8, r8</i>	Valid	Valid*	Compare AL with <i>r/m8</i> . If equal, ZF is set and <i>r8</i> is loaded into <i>r/m8</i> . Else, clear ZF and load <i>r/m8</i> into AL.
REX + OF B0/ <i>r</i>	CMPXCHG <i>r/m8**, r8</i>	Valid	N.E.	Compare AL with <i>r/m8</i> . If equal, ZF is set and <i>r8</i> is loaded into <i>r/m8</i> . Else, clear ZF and load <i>r/m8</i> into AL.
OF B1/ <i>r</i>	CMPXCHG <i>r/m16, r16</i>	Valid	Valid*	Compare AX with <i>r/m16</i> . If equal, ZF is set and <i>r16</i> is loaded into <i>r/m16</i> . Else, clear ZF and load <i>r/m16</i> into AX.
OF B1/ <i>r</i>	CMPXCHG <i>r/m32, r32</i>	Valid	Valid*	Compare EAX with <i>r/m32</i> . If equal, ZF is set and <i>r32</i> is loaded into <i>r/m32</i> . Else, clear ZF and load <i>r/m32</i> into EAX.
REX.W + OF B1/ <i>r</i>	CMPXCHG <i>r/m64, r64</i>	Valid	N.E.	Compare RAX with <i>r/m64</i> . If equal, ZF is set and <i>r64</i> is loaded into <i>r/m64</i> . Else, clear ZF and load <i>r/m64</i> into RAX.

NOTES:

* See the IA-32 Architecture Compatibility section below.

** In 64-bit mode, *r/m8* can not be encoded to access the following byte registers if a REX prefix is used: AH, BH, CH, DH.

Description

Compares the value in the AL, AX, EAX, or RAX register with the first operand (destination operand). If the two values are equal, the second operand (source operand) is loaded into the destination operand. Otherwise, the destination operand is loaded into the AL, AX, EAX or RAX register. RAX register is available only in 64-bit mode.

This instruction can be used with a LOCK prefix to allow the instruction to be executed atomically. To simplify the interface to the processor's bus, the destination operand receives a write cycle without regard to the result of the comparison. The destination operand is written back if the comparison fails; otherwise, the source operand is written into the destination. (The processor never produces a locked read without also producing a locked write.)

In 64-bit mode, the instruction's default operation size is 32 bits. Use of the REX.R prefix permits access to additional registers (R8-R15). Use of the REX.W prefix promotes operation to 64 bits. See the summary chart at the beginning of this section for encoding data and limits.

IA-32 Architecture Compatibility

This instruction is not supported on Intel processors earlier than the Intel486 processors.

Operation

(* Accumulator = AL, AX, EAX, or RAX depending on whether a byte, word, doubleword, or quadword comparison is being performed *)

```
IF accumulator = DEST
    THEN
        ZF ← 1;
        DEST ← SRC;
    ELSE
        ZF ← 0;
        accumulator ← DEST;
FI;
```

Flags Affected

The ZF flag is set if the values in the destination operand and register AL, AX, or EAX are equal; otherwise it is cleared. The CF, PF, AF, SF, and OF flags are set according to the results of the comparison operation.

Protected Mode Exceptions

#GP(0)	If the destination is located in a non-writable segment. If a memory operand effective address is outside the CS, DS, ES, FS, or GS segment limit. If the DS, ES, FS, or GS register contains a NULL segment selector.
#SS(0)	If a memory operand effective address is outside the SS segment limit.
#PF(fault-code)	If a page fault occurs.
#AC(0)	If alignment checking is enabled and an unaligned memory reference is made while the current privilege level is 3.
#UD	If the LOCK prefix is used but the destination is not a memory operand.

Real-Address Mode Exceptions

#GP	If a memory operand effective address is outside the CS, DS, ES, FS, or GS segment limit.
#SS	If a memory operand effective address is outside the SS segment limit.
#UD	If the LOCK prefix is used but the destination is not a memory operand.

Virtual-8086 Mode Exceptions

#GP(0)	If a memory operand effective address is outside the CS, DS, ES, FS, or GS segment limit.
#SS(0)	If a memory operand effective address is outside the SS segment limit.
#PF(fault-code)	If a page fault occurs.
#AC(0)	If alignment checking is enabled and an unaligned memory reference is made.
#UD	If the LOCK prefix is used but the destination is not a memory operand.

Compatibility Mode Exceptions

Same exceptions as in protected mode.

64-Bit Mode Exceptions

#SS(0)	If a memory address referencing the SS segment is in a non-canonical form.
#GP(0)	If the memory address is in a non-canonical form.
#PF(fault-code)	If a page fault occurs.
#AC(0)	If alignment checking is enabled and an unaligned memory reference is made while the current privilege level is 3.
#UD	If the LOCK prefix is used but the destination is not a memory operand.

CMPXCHG8B/CMPXCHG16B—Compare and Exchange Bytes

Opcode*	Instruction	64-Bit Mode	Compat/Leg Mode	Description
OF C7 /1 <i>m64</i>	CMPXCHG8B <i>m64</i>	Valid	Valid*	Compare EDX:EAX with <i>m64</i> . If equal, set ZF and load ECX:EBX into <i>m64</i> . Else, clear ZF and load <i>m64</i> into EDX:EAX.
REX.W + OF C7 /1 <i>m128</i>	CMPXCHG16B <i>m128</i>	Valid	N.E.	Compare RDX:RAX with <i>m128</i> . If equal, set ZF and load RCX:RBX into <i>m128</i> . Else, clear ZF and load <i>m128</i> into RDX:RAX.

NOTES:

* See IA-32 Architecture Compatibility section below.

Description

Compares the 64-bit value in EDX:EAX (or 128-bit value in RDX:RAX if operand size is 128 bits) with the operand (destination operand). If the values are equal, the 64-bit value in ECX:EBX (or 128-bit value in RCX:RBX) is stored in the destination operand. Otherwise, the value in the destination operand is loaded into EDX:EAX (or RDX:RAX). The destination operand is an 8-byte memory location (or 16-byte memory location if operand size is 128 bits). For the EDX:EAX and ECX:EBX register pairs, EDX and ECX contain the high-order 32 bits and EAX and EBX contain the low-order 32 bits of a 64-bit value. For the RDX:RAX and RCX:RBX register pairs, RDX and RCX contain the high-order 64 bits and RAX and RBX contain the low-order 64 bits of a 128-bit value.

This instruction can be used with a LOCK prefix to allow the instruction to be executed atomically. To simplify the interface to the processor's bus, the destination operand receives a write cycle without regard to the result of the comparison. The destination operand is written back if the comparison fails; otherwise, the source operand is written into the destination. (The processor never produces a locked read without also producing a locked write.)

In 64-bit mode, default operation size is 64 bits. Use of the REX.W prefix promotes operation to 128 bits. Note that CMPXCHG16B requires that the destination (memory) operand be 16-byte aligned. See the summary chart at the beginning of this section for encoding data and limits. For information on the CPUID flag that indicates CMPXCHG16B, see page 3-193.

IA-32 Architecture Compatibility

This instruction encoding is not supported on Intel processors earlier than the Pentium processors.

Operation

```

IF (64-Bit Mode and OperandSize = 64)
  THEN
    IF (RDX:RAX = DEST)
      ZF ← 1;
      DEST ← RCX:RBX;
    ELSE
      ZF ← 0;
      RDX:RAX ← DEST;
    FI
  ELSE
    IF (EDX:EAX = DEST)
      ZF ← 1;
      DEST ← ECX:EBX;
    ELSE
      ZF ← 0;
      EDX:EAX ← DEST;
    FI;
  FI;

```

Flags Affected

The ZF flag is set if the destination operand and EDX:EAX are equal; otherwise it is cleared. The CF, PF, AF, SF, and OF flags are unaffected.

Protected Mode Exceptions

#UD	If the destination is not a memory operand.
#GP(0)	If the destination is located in a non-writable segment. If a memory operand effective address is outside the CS, DS, ES, FS, or GS segment limit. If the DS, ES, FS, or GS register contains a NULL segment selector.
#SS(0)	If a memory operand effective address is outside the SS segment limit.
#PF(fault-code)	If a page fault occurs.
#AC(0)	If alignment checking is enabled and an unaligned memory reference is made while the current privilege level is 3.

Real-Address Mode Exceptions

#UD	If the destination operand is not a memory location.
#GP	If a memory operand effective address is outside the CS, DS, ES, FS, or GS segment limit.

#SS If a memory operand effective address is outside the SS segment limit.

Virtual-8086 Mode Exceptions

#UD If the destination operand is not a memory location.

#GP(0) If a memory operand effective address is outside the CS, DS, ES, FS, or GS segment limit.

#SS(0) If a memory operand effective address is outside the SS segment limit.

#PF(fault-code) If a page fault occurs.

#AC(0) If alignment checking is enabled and an unaligned memory reference is made.

Compatibility Mode Exceptions

Same exceptions as in protected mode.

64-Bit Mode Exceptions

#SS(0) If a memory address referencing the SS segment is in a non-canonical form.

#GP(0) If the memory address is in a non-canonical form.
If memory operand for CMPXCHG16B is not aligned on a 16-byte boundary.
If `CPUID.01H:ECX.CMPXCHG16B[bit 13] = 0`.

#UD If the destination operand is not a memory location.

#PF(fault-code) If a page fault occurs.

#AC(0) If alignment checking is enabled and an unaligned memory reference is made while the current privilege level is 3.

COMISD—Compare Scalar Ordered Double-Precision Floating-Point Values and Set EFLAGS

Opcode	Instruction	64-Bit Mode	Compat/ Leg Mode	Description
66 0F 2F /r	COMISD <i>xmm1</i> , <i>xmm2/mem64</i>	Valid	Valid	Compare low double-precision floating-point values in <i>xmm1</i> and <i>xmm2/mem64</i> and set the EFLAGS flags accordingly.

Description

Compares the double-precision floating-point values in the low quadwords of operand 1 (first operand) and operand 2 (second operand), and sets the ZF, PF, and CF flags in the EFLAGS register according to the result (unordered, greater than, less than, or equal). The OF, SF and AF flags in the EFLAGS register are set to 0. The unordered result is returned if either source operand is a NaN (QNaN or SNaN).

Operand 1 is an XMM register; operand 2 can be an XMM register or a 64 bit memory location.

The COMISD instruction differs from the UCOMISD instruction in that it signals a SIMD floating-point invalid operation exception (#1) when a source operand is either a QNaN or SNaN. The UCOMISD instruction signals an invalid numeric exception only if a source operand is an SNaN.

The EFLAGS register is not updated if an unmasked SIMD floating-point exception is generated.

In 64-bit mode, use of the REX.R prefix permits this instruction to access additional registers (XMM8-XMM15).

Operation

```
RESULT ← OrderedCompare(DEST[63:0] <> SRC[63:0]) {
(* Set EFLAGS *) CASE (RESULT) OF
  UNORDERED:      ZF,PF,CF ← 111;
  GREATER_THAN:   ZF,PF,CF ← 000;
  LESS_THAN:      ZF,PF,CF ← 001;
  EQUAL:          ZF,PF,CF ← 100;
ESAC;
OF, AF, SF ← 0; }
```

Intel C/C++ Compiler Intrinsic Equivalents

```
int _mm_comieq_sd (__m128d a, __m128d b)
```

```
int _mm_comilt_sd (__m128d a, __m128d b)
int _mm_comile_sd (__m128d a, __m128d b)
int _mm_comigt_sd (__m128d a, __m128d b)
int _mm_comige_sd (__m128d a, __m128d b)
int _mm_comineq_sd (__m128d a, __m128d b)
```

SIMD Floating-Point Exceptions

Invalid (if SNaN or QNaN operands), Denormal.

Protected Mode Exceptions

#GP(0)	For an illegal memory operand effective address in the CS, DS, ES, FS or GS segments.
#SS(0)	For an illegal address in the SS segment.
#PF(fault-code)	For a page fault.
#NM	If CR0.TS[bit 3] = 1.
#XM	If an unmasked SIMD floating-point exception and CR4.OSXMMEXCPT[bit 10] = 1.
#UD	If an unmasked SIMD floating-point exception and CR4.OSXMMEXCPT[bit 10] = 0. If CR0.EM[bit 2] = 1. If CR4.OSFXSR[bit 9] = 0. If CPUID.01H:EDX.SSE2[bit 26] = 0. If the LOCK prefix is used.
#AC(0)	If alignment checking is enabled and an unaligned memory reference is made while the current privilege level is 3.

Real-Address Mode Exceptions

GP	If any part of the operand lies outside the effective address space from 0 to FFFFH.
#NM	If CR0.TS[bit 3] = 1.
#XM	If an unmasked SIMD floating-point exception and CR4.OSXMMEXCPT[bit 10] = 1.
#UD	If an unmasked SIMD floating-point exception and CR4.OSXMMEXCPT[bit 10] = 0. If CR0.EM[bit 2] = 1. If CR4.OSFXSR[bit 9] = 0. If CPUID.01H:EDX.SSE2[bit 26] = 0. If the LOCK prefix is used.

Virtual-8086 Mode Exceptions

Same exceptions as in real address mode.

#PF(fault-code)	For a page fault.
#AC(0)	If alignment checking is enabled and an unaligned memory reference is made.
#UD	If the LOCK prefix is used.

Compatibility Mode Exceptions

Same exceptions as in protected mode.

64-Bit Mode Exceptions

#SS(0)	If a memory address referencing the SS segment is in a non-canonical form.
#GP(0)	If the memory address is in a non-canonical form.
#PF(fault-code)	For a page fault.
#NM	If $CR0.TS[\text{bit } 3] = 1$.
#XM	If an unmasked SIMD floating-point exception and $CR4.OSXMMEXCPT[\text{bit } 10] = 1$.
#UD	If an unmasked SIMD floating-point exception and $CR4.OSXMMEXCPT[\text{bit } 10] = 0$. If $CR0.EM[\text{bit } 2] = 1$. If $CR4.OSFXSR[\text{bit } 9] = 0$. If $CPUID.01H:EDX.SSE2[\text{bit } 26] = 0$. If the LOCK prefix is used.
#AC(0)	If alignment checking is enabled and an unaligned memory reference is made while the current privilege level is 3.

COMISS—Compare Scalar Ordered Single-Precision Floating-Point Values and Set EFLAGS

Opcode	Instruction	64-Bit Mode	Compat/Leg Mode	Description
OF 2F /r	COMISS <i>xmm1</i> , <i>xmm2/mem32</i>	Valid	Valid	Compare low single-precision floating-point values in <i>xmm1</i> and <i>xmm2/mem32</i> and set the EFLAGS flags accordingly.

Description

Compares the single-precision floating-point values in the low doublewords of operand 1 (first operand) and operand 2 (second operand), and sets the ZF, PF, and CF flags in the EFLAGS register according to the result (unordered, greater than, less than, or equal). The OF, SF, and AF flags in the EFLAGS register are set to 0. The unordered result is returned if either source operand is a NaN (QNaN or SNaN).

Operand 1 is an XMM register; Operand 2 can be an XMM register or a 32 bit memory location.

The COMISS instruction differs from the UCOMISS instruction in that it signals a SIMD floating-point invalid operation exception (#1) when a source operand is either a QNaN or SNaN. The UCOMISS instruction signals an invalid numeric exception only if a source operand is an SNaN.

The EFLAGS register is not updated if an unmasked SIMD floating-point exception is generated.

In 64-bit mode, use of the REX.R prefix permits this instruction to access additional registers (XMM8-XMM15).

Operation

```
RESULT ← OrderedCompare(SRC1[31:0] <> SRC2[31:0]) {
(* Set EFLAGS *) CASE (RESULT) OF
  UNORDERED:      ZF,PF,CF ← 111;
  GREATER_THAN:   ZF,PF,CF ← 000;
  LESS_THAN:      ZF,PF,CF ← 001;
  EQUAL:          ZF,PF,CF ← 100;
ESAC;
OF,AF,SF ← 0; }
```

Intel C/C++ Compiler Intrinsic Equivalents

```
int _mm_comieq_ss (__m128 a, __m128 b)
```

```
int _mm_comilt_ss (__m128 a, __m128 b)
```

```
int _mm_comile_ss (__m128 a, __m128 b)
int _mm_comigt_ss (__m128 a, __m128 b)
int _mm_comige_ss (__m128 a, __m128 b)
int _mm_comineq_ss (__m128 a, __m128 b)
```

SIMD Floating-Point Exceptions

Invalid (if SNaN or QNaN operands), Denormal.

Protected Mode Exceptions

#GP(0)	For an illegal memory operand effective address in the CS, DS, ES, FS or GS segments.
#SS(0)	For an illegal address in the SS segment.
#PF(fault-code)	For a page fault.
#NM	If CR0.TS[bit 3] = 1.
#XM	If an unmasked SIMD floating-point exception and CR4.OSXMMEXCPT[bit 10] = 1.
#UD	If an unmasked SIMD floating-point exception and CR4.OSXMMEXCPT[bit 10] = 0. If CR0.EM[bit 2] = 1. If CR4.OSFXSR[bit 9] = 0. If CPUID.01H: EDX.SSE[bit 25] = 0. If the LOCK prefix is used.
#AC(0)	If alignment checking is enabled and an unaligned memory reference is made while the current privilege level is 3.

Real-Address Mode Exceptions

GP	If any part of the operand lies outside the effective address space from 0 to FFFFH.
#NM	If CR0.TS[bit 3] = 1.
#XM	If an unmasked SIMD floating-point exception and CR4.OSXMMEXCPT[bit 10] = 1.
#UD	If an unmasked SIMD floating-point exception and CR4.OSXMMEXCPT[bit 10] = 0. If CR0.EM[bit 2] = 1. If CR4.OSFXSR[bit 9] = 0. If CPUID.01H: EDX.SSE[bit 25] = 0. If the LOCK prefix is used.

Virtual-8086 Mode Exceptions

Same exceptions as in real address mode.

- #PF(fault-code) For a page fault.
- #AC(0) If alignment checking is enabled and an unaligned memory reference is made.

Compatibility Mode Exceptions

Same exceptions as in protected mode.

64-Bit Mode Exceptions

- #SS(0) If a memory address referencing the SS segment is in a non-canonical form.
- #GP(0) If the memory address is in a non-canonical form.
- #PF(fault-code) For a page fault.
- #NM If $\text{CR0.TS}[\text{bit } 3] = 1$.
- #XM If an unmasked SIMD floating-point exception and $\text{CR4.OSXMMEXCPT}[\text{bit } 10] = 1$.
- #UD If an unmasked SIMD floating-point exception and $\text{CR4.OSXMMEXCPT}[\text{bit } 10] = 0$.
If $\text{CR0.EM}[\text{bit } 2] = 1$.
If $\text{CR4.OSFXSR}[\text{bit } 9] = 0$.
If $\text{CPUID.01H:EDX.SSE}[\text{bit } 25] = 0$.
- #AC(0) If the LOCK prefix is used.
If alignment checking is enabled and an unaligned memory reference is made while the current privilege level is 3.

CPUID—CPU Identification

Opcode	Instruction	64-Bit Mode	Compat/ Leg Mode	Description
0F A2	CPUID	Valid	Valid	Returns processor identification and feature information to the EAX, EBX, ECX, and EDX registers, as determined by input entered in EAX (in some cases, ECX as well).

Description

The ID flag (bit 21) in the EFLAGS register indicates support for the CPUID instruction. If a software procedure can set and clear this flag, the processor executing the procedure supports the CPUID instruction. This instruction operates the same in non-64-bit modes and 64-bit mode.

CPUID returns processor identification and feature information in the EAX, EBX, ECX, and EDX registers.¹ The instruction's output is dependent on the contents of the EAX register upon execution (in some cases, ECX as well). For example, the following pseudocode loads EAX with 00H and causes CPUID to return a Maximum Return Value and the Vendor Identification String in the appropriate registers:

```
MOV EAX, 00H
CPUID
```

Table 3-20 shows information returned, depending on the initial value loaded into the EAX register. Table 3-21 shows the maximum CPUID input value recognized for each family of IA-32 processors on which CPUID is implemented.

Two types of information are returned: basic and extended function information. If a value entered for CPUID.EAX is invalid for a particular processor, the data for the highest basic information leaf is returned. For example, using the Intel Core i7 processor, the following is true:

```
CPUID.EAX = 05H (* Returns MONITOR/MWAIT leaf. *)
CPUID.EAX = 0AH (* Returns Architectural Performance Monitoring leaf. *)
CPUID.EAX = 0BH (* Returns Extended Topology Enumeration leaf. *)
CPUID.EAX = 0CH (* INVALID: Returns the same information as CPUID.EAX = 0BH. *)
CPUID.EAX = 80000008H (* Returns linear/physical address size data. *)
CPUID.EAX = 8000000AH (* INVALID: Returns same information as CPUID.EAX = 0BH. *)
```

When CPUID returns the highest basic leaf information as a result of an invalid input EAX value, any dependence on input ECX value in the basic leaf is honored.

1. On Intel 64 processors, CPUID clears the high 32 bits of the RAX/RBX/RCX/RDX registers in all modes.

CPUID can be executed at any privilege level to serialize instruction execution. Serializing instruction execution guarantees that any modifications to flags, registers, and memory for previous instructions are completed before the next instruction is fetched and executed.

See also:

“Serializing Instructions” in Chapter 8, “Multiple-Processor Management,” in the *Intel® 64 and IA-32 Architectures Software Developer’s Manual, Volume 3A*

TLBs, Paging-Structure Caches, and Their Invalidation (Order Number 241618)

Table 3-20. Information Returned by CPUID Instruction

Initial EAX Value	Information Provided about the Processor	
0H	<i>Basic CPUID Information</i>	
	EAX	Maximum Input Value for Basic CPUID Information (see Table 3-21)
	EBX	“Genu”
	ECX	“ntel”
01H	EDX	“intel”
	EAX	Version Information: Type, Family, Model, and Stepping ID (see Figure 3-6)
	EBX	Bits 7-0: Brand Index Bits 15-8: CLFLUSH line size (Value * 8 = cache line size in bytes) Bits 23-16: Maximum number of addressable IDs for logical processors in this physical package*. Bits 31-24: Initial APIC ID
	ECX	Feature Information (see Figure 3-7 and Table 3-23)
	EDX	Feature Information (see Figure 3-8 and Table 3-24)
	NOTES:	
	* The nearest power-of-2 integer that is not smaller than EBX[23:16] is the number of unique initial APIC IDs reserved for addressing different logical processors in a physical package.	
02H	EAX	Cache and TLB Information (see Table 3-25)
	EBX	Cache and TLB Information
	ECX	Cache and TLB Information
	EDX	Cache and TLB Information

Table 3-20. Information Returned by CPUID Instruction (Contd.)

Initial EAX Value	Information Provided about the Processor	
03H	EAX	Reserved.
	EBX	Reserved.
	ECX	Bits 00-31 of 96 bit processor serial number. (Available in Pentium III processor only; otherwise, the value in this register is reserved.)
	EDX	Bits 32-63 of 96 bit processor serial number. (Available in Pentium III processor only; otherwise, the value in this register is reserved.)
	<p>NOTES:</p> <p>Processor serial number (PSN) is not supported in the Pentium 4 processor or later. On all models, use the PSN flag (returned using CPUID) to check for PSN support before accessing the feature.</p>	
	<p>See AP-485, <i>Intel Processor Identification and the CPUID Instruction</i> (Order Number 241618) for more information on PSN.</p>	
	<p>CPUID leaves > 3 < 80000000 are visible only when IA32_MISC_ENABLES.BOOT_NT4[bit 22] = 0 (default).</p>	
	<p><i>Deterministic Cache Parameters Leaf</i></p>	
04H	<p>NOTES:</p> <p>Leaf 04H output depends on the initial value in ECX. See also: "INPUT EAX = 4: Returns Deterministic Cache Parameters for each level on page 3-203.</p> <p>EAX</p> <p>Bits 4-0: Cache Type Field 0 = Null - No more caches 1 = Data Cache 2 = Instruction Cache 3 = Unified Cache 4-31 = Reserved</p> <p>Bits 7-5: Cache Level (starts at 1) Bits 8: Self Initializing cache level (does not need SW initialization) Bits 9: Fully Associative cache</p> <p>Bits 13-10: Reserved Bits 25-14: Maximum number of addressable IDs for logical processors sharing this cache*, ** Bits 31-26: Maximum number of addressable IDs for processor cores in the physical package*, ***, ****</p> <p>EBX</p> <p>Bits 11-00: L = System Coherency Line Size* Bits 21-12: P = Physical Line partitions* Bits 31-22: W = Ways of associativity*</p>	

Table 3-20. Information Returned by CPUID Instruction (Contd.)

Initial EAX Value	Information Provided about the Processor	
	ECX	Bits 31-00: S = Number of Sets*
	EDX	Bit 0: Write-Back Invalidate/Invalidate 0 = WBINVD/INVD from threads sharing this cache acts upon lower level caches for threads sharing this cache 1 = WBINVD/INVD is not guaranteed to act upon lower level caches of non-originating threads sharing this cache. Bit 1: Cache Inclusiveness 0 = Cache is not inclusive of lower cache levels. 1 = Cache is inclusive of lower cache levels. Bits 31-02: Reserved = 0
	NOTES: * Add one to the return value to get the result. ** The nearest power-of-2 integer that is not smaller than (1 + EAX[25:14]) is the number of unique initial APIC IDs reserved for addressing different logical processors sharing this cache *** The nearest power-of-2 integer that is not smaller than (1 + EAX[31:26]) is the number of unique Core_IDs reserved for addressing different processor cores in a physical package. Core ID is a subset of bits of the initial APIC ID. ****The returned value is constant for valid initial values in ECX. Valid ECX values start from 0.	
	<i>MONITOR/MWAIT Leaf</i>	
5H	EAX	Bits 15-00: Smallest monitor-line size in bytes (default is processor's monitor granularity) Bits 31-16: Reserved = 0
	EBX	Bits 15-00: Largest monitor-line size in bytes (default is processor's monitor granularity) Bits 31-16: Reserved = 0
	ECX	Bits 00: Enumeration of Monitor-Mwait extensions (beyond EAX and EBX registers) supported Bits 01: Supports treating interrupts as break-event for MWAIT, even when interrupts disabled Bits 31 - 02: Reserved

Table 3-20. Information Returned by CPUID Instruction (Contd.)

Initial EAX Value	Information Provided about the Processor
	EBX Bit 0: Core cycle event not available if 1 Bit 1: Instruction retired event not available if 1 Bit 2: Reference cycles event not available if 1 Bit 3: Last-level cache reference event not available if 1 Bit 4: Last-level cache misses event not available if 1 Bit 5: Branch instruction retired event not available if 1 Bit 6: Branch mispredict retired event not available if 1 Bits 31- 07: Reserved = 0 ECX Reserved = 0
	EDX Bits 04 - 00: Number of fixed-function performance counters (if Version ID > 1) Bits 12- 05: Bit width of fixed-function performance counters (if Version ID > 1) Reserved = 0
	<i>Extended Topology Enumeration Leaf</i>
0BH	NOTES: Most of Leaf 0BH output depends on the initial value in ECX. EDX output do not vary with initial value in ECX. ECX[7:0] output always reflect initial value in ECX. All other output value for an invalid initial value in ECX are 0. Leaf 0BH exists if EBX[15:0] is not zero. EAX Bits 4-0: Number of bits to shift right on x2APIC ID to get a unique topology ID of the next level type*. All logical processors with the same next level ID share current level. Bits 31-5: Reserved. EBX Bits 15 - 00: Number of logical processors at this level type. The number reflects configuration as shipped by Intel**. Bits 31- 16: Reserved. ECX Bits 07 - 00: Level number. Same value in ECX input Bits 15 - 08: Level type***. Bits 31 - 16: Reserved. EDX Bits 31- 0: x2APIC ID the current logical processor.
	NOTES: * Software should use this field (EAX[4:0]) to enumerate processor topology of the system.

Table 3-20. Information Returned by CPUID Instruction (Contd.)

Initial EAX Value	Information Provided about the Processor
	<p>** Software must not use EBX[15:0] to enumerate processor topology of the system. This value in this field (EBX[15:0]) is only intended for display/diagnostic purposes. The actual number of logical processors available to BIOS/OS/Applications may be different from the value of EBX[15:0], depending on software and platform hardware configurations.</p> <p>*** The value of the “level type” field is not related to level numbers in any way, higher “level type” values do not mean higher levels. Level type field has the following encoding: 0 : invalid 1 : SMT 2 : Core 3-255 : Reserved</p>
	<p><i>Processor Extended State Enumeration Main Leaf (EAX = 0DH, ECX = 0)</i></p>
0DH	<p>NOTES: Leaf 0DH main leaf (ECX = 0).</p> <p>EAX Bits 31-0: Reports the valid bit fields of the lower 32 bits of the XFEATURE_ENABLED_MASK register (XCRO). If a bit is 0, the corresponding bit field in XCRO is reserved.</p>
	<p>EBX Bits 31-0: Maximum size (bytes) required by enabled features in XFEATURE_ENABLED_MASK (XCRO). May be different than ECX when features at the end of the save area are not enabled.</p> <p>ECX Bit 31-0: Maximum size (bytes) of the XSAVE/XRSTOR save area required by all supported features in the processor, i.e all the valid bit fields in XFEATURE_ENABLED_MASK. This includes the size needed for the XSAVE.HEADER.</p> <p>EDX Bit 31-0: Reports the valid bit fields of the upper 32 bits of the XFEATURE_ENABLED_MASK register (XCRO). If a bit is 0, the corresponding bit field in XCRO is reserved</p>
	<p><i>Processor Extended State Enumeration Sub-leaf (EAX = 0DH, ECX = 1)</i></p>
	<p>EAX Reserved</p> <p>EBX Reserved</p> <p>ECX Reserved</p> <p>EDX Reserved</p>

Table 3-20. Information Returned by CPUID Instruction (Contd.)

Initial EAX Value	Information Provided about the Processor	
	<i>Processor Extended State Enumeration Sub-leaves (EAX = 0DH, ECX = n, n > 1)</i>	
0DH	<p>NOTES:</p> <p>Leaf 0DH output depends on the initial value in ECX. If ECX contains an invalid sub leaf index, EAX/EBX/ECX/EDX return 0.</p> <p>EAX Bits 31-0: The size in bytes of the save area for an extended state feature associated with a valid sub-leaf index, <i>n</i>. Each valid sub-leaf index maps to a valid bit in the XFEATURE_ENABLED_MASK register (XCRO) starting at bit position 2. This field reports 0 if the sub-leaf index, <i>n</i>, is invalid*.</p> <p>EBX Bits 31-0: The offset in bytes of the save area from the beginning of the XSAVE/XRSTOR area. This field reports 0 if the sub-leaf index, <i>n</i>, is invalid*.</p>	
	ECX	This field reports 0 if the sub-leaf index, <i>n</i> , is invalid*; otherwise it is reserved.
	EDX	This field reports 0 if the sub-leaf index, <i>n</i> , is invalid*; otherwise it is reserved.
<i>Unimplemented CPUID Leaf Functions</i>		
40000000H - 4FFFFFFFH H		Invalid. No existing or future CPU will return processor identification or feature information if the initial EAX value is in the range 40000000H to 4FFFFFFFH.
<i>Extended Function CPUID Information</i>		
80000000H	EAX	Maximum Input Value for Extended Function CPUID Information (see Table 3-21).
	EBX	Reserved
	ECX	Reserved
	EDX	Reserved
80000001H	EAX	Extended Processor Signature and Feature Bits.
	EBX	Reserved
	ECX	Bit 0: LAHF/SAHF available in 64-bit mode Bits 31-1 Reserved

Table 3-20. Information Returned by CPUID Instruction (Contd.)

Initial EAX Value	Information Provided about the Processor	
	EDX	Bits 10-0: Reserved Bit 11: SYSCALL/SYSRET available (when in 64-bit mode) Bits 19-12: Reserved = 0 Bit 20: Execute Disable Bit available Bits 26-21: Reserved = 0 Bit 27: RDTSCP and IA32_TSC_AUX are available if 1 Bits 28: Reserved = 0 Bit 29: Intel® 64 Architecture available if 1 Bits 31-30: Reserved = 0
80000002H	EAX EBX ECX EDX	Processor Brand String Processor Brand String Continued Processor Brand String Continued Processor Brand String Continued
80000003H	EAX EBX ECX EDX	Processor Brand String Continued Processor Brand String Continued Processor Brand String Continued Processor Brand String Continued
80000004H	EAX EBX ECX EDX	Processor Brand String Continued Processor Brand String Continued Processor Brand String Continued Processor Brand String Continued
80000005H	EAX EBX ECX EDX	Reserved = 0 Reserved = 0 Reserved = 0 Reserved = 0
80000006H	EAX EBX ECX EDX	Reserved = 0 Reserved = 0 Bits 7-0: Cache Line size in bytes Bits 15-12: L2 Associativity field * Bits 31-16: Cache size in 1K units Reserved = 0
		<p>NOTES:</p> <p>* L2 associativity field encodings: 00H - Disabled 01H - Direct mapped 02H - 2-way 04H - 4-way 06H - 8-way 08H - 16-way 0FH - Fully associative</p>

Table 3-20. Information Returned by CPUID Instruction (Contd.)

Initial EAX Value	Information Provided about the Processor	
80000007H	EAX EBX ECX EDX	Reserved = 0 Reserved = 0 Reserved = 0 Bits 7-0: Reserved = 0 Bit 8: Invariant TSC available if 1 Bits 31-9: Reserved = 0
80000008H	EAX	Linear/Physical Address size Bits 7-0: #Physical Address Bits* Bits 15-8: #Linear Address Bits Bits 31-16: Reserved = 0
	EBX ECX EDX	Reserved = 0 Reserved = 0 Reserved = 0 NOTES: * If CPUID.80000008H:EAX[7:0] is supported, the maximum physical address number supported should come from this field.

INPUT EAX = 0: Returns CPUID's Highest Value for Basic Processor Information and the Vendor Identification String

When CPUID executes with EAX set to 0, the processor returns the highest value the CPUID recognizes for returning basic processor information. The value is returned in the EAX register (see Table 3-21) and is processor specific.

A vendor identification string is also returned in EBX, EDX, and ECX. For Intel processors, the string is "GenuineIntel" and is expressed:

EBX ← 756e6547h (* "Genu", with G in the low four bits of BL *)

EDX ← 49656e69h (* "inel", with i in the low four bits of DL *)

ECX ← 6c65746eh (* "ntel", with n in the low four bits of CL *)

INPUT EAX = 80000000H: Returns CPUID's Highest Value for Extended Processor Information

When CPUID executes with EAX set to 0, the processor returns the highest value the processor recognizes for returning extended processor information. The value is returned in the EAX register (see Table 3-21) and is processor specific.

Table 3-21. Highest CPUID Source Operand for Intel 64 and IA-32 Processors

Intel 64 or IA-32 Processors	Highest Value in EAX	
	Basic Information	Extended Function Information
Earlier Intel486 Processors	CPUID Not Implemented	CPUID Not Implemented
Later Intel486 Processors and Pentium Processors	01H	Not Implemented
Pentium Pro and Pentium II Processors, Intel® Celeron® Processors	02H	Not Implemented
Pentium III Processors	03H	Not Implemented
Pentium 4 Processors	02H	80000004H
Intel Xeon Processors	02H	80000004H
Pentium M Processor	02H	80000004H
Pentium 4 Processor supporting Hyper-Threading Technology	05H	80000008H
Pentium D Processor (8xx)	05H	80000008H
Pentium D Processor (9xx)	06H	80000008H
Intel Core Duo Processor	0AH	80000008H
Intel Core 2 Duo Processor	0AH	80000008H
Intel Xeon Processor 3000, 5100, 5200, 5300, 5400 Series	0AH	80000008H
Intel Core 2 Duo Processor 8000 Series	0DH	80000008H
Intel Xeon Processor 5200, 5400 Series	0AH	80000008H
Intel Atom Processor	0AH	80000008H
Intel Core i7 Processor	0BH	80000008H

IA32_BIOS_SIGN_ID Returns Microcode Update Signature

For processors that support the microcode update facility, the IA32_BIOS_SIGN_ID MSR is loaded with the update signature whenever CPUID executes. The signature is returned in the upper DWORD. For details, see Chapter 9 in the *Intel® 64 and IA-32 Architectures Software Developer's Manual, Volume 3A*.

INPUT EAX = 1: Returns Model, Family, Stepping Information

When CPUID executes with EAX set to 1, version information is returned in EAX (see Figure 3-6). For example: model, family, and processor type for the Intel Xeon processor 5100 series is as follows:

- Model — 1111B
- Family — 0101B
- Processor Type — 00B

See Table 3-22 for available processor type values. Stepping IDs are provided as needed.

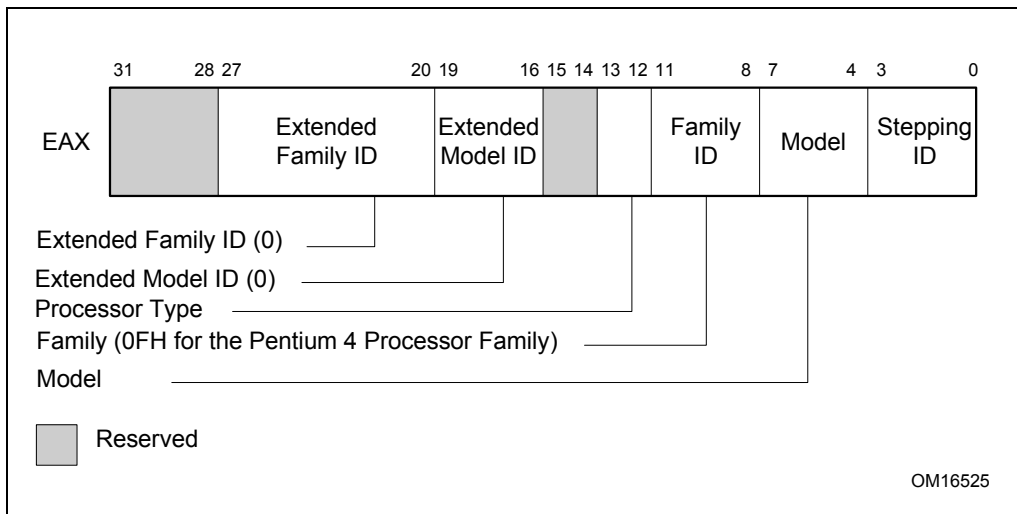

Figure 3-6. Version Information Returned by CPUID in EAX

Table 3-22. Processor Type Field

Type	Encoding
Original OEM Processor	00B
Intel OverDrive™ Processor	01B
Dual processor (not applicable to Intel486 processors)	10B
Intel reserved	11B

NOTE

See *TLBs, Paging-Structure Caches, and Their Invalidation* (Order Number 241618) and Chapter 14 in the *Intel® 64 and IA-32 Archi-*

lectures Software Developer's Manual, Volume 1, for information on identifying earlier IA-32 processors.

The Extended Family ID needs to be examined only when the Family ID is 0FH. Integrate the fields into a display using the following rule:

```
IF Family_ID ≠ 0FH
    THEN Displayed_Family = Family_ID;
    ELSE Displayed_Family = Extended_Family_ID + Family_ID;
    (* Right justify and zero-extend 4-bit field. *)
FI;
(* Show Display_Family as HEX field. *)
```

The Extended Model ID needs to be examined only when the Family ID is 06H or 0FH. Integrate the field into a display using the following rule:

```
IF (Family_ID = 06H or Family_ID = 0FH)
    THEN Displayed_Model = (Extended_Model_ID << 4) + Model_ID;
    (* Right justify and zero-extend 4-bit field; display Model_ID as HEX field.*)
    ELSE Displayed_Model = Model_ID;
FI;
(* Show Display_Model as HEX field. *)
```

INPUT EAX = 1: Returns Additional Information in EBX

When CPUID executes with EAX set to 1, additional information is returned to the EBX register:

- Brand index (low byte of EBX) — this number provides an entry into a brand string table that contains brand strings for IA-32 processors. More information about this field is provided later in this section.
- CLFLUSH instruction cache line size (second byte of EBX) — this number indicates the size of the cache line flushed with CLFLUSH instruction in 8-byte increments. This field was introduced in the Pentium 4 processor.
- Local APIC ID (high byte of EBX) — this number is the 8-bit ID that is assigned to the local APIC on the processor during power up. This field was introduced in the Pentium 4 processor.

INPUT EAX = 1: Returns Feature Information in ECX and EDX

When CPUID executes with EAX set to 1, feature information is returned in ECX and EDX.

- Figure 3-7 and Table 3-23 show encodings for ECX.
- Figure 3-8 and Table 3-24 show encodings for EDX.

For all feature flags, a 1 indicates that the feature is supported. Use Intel to properly interpret feature flags.

NOTE

Software must confirm that a processor feature is present using feature flags returned by CPUID prior to using the feature. Software should not depend on future offerings retaining all features.

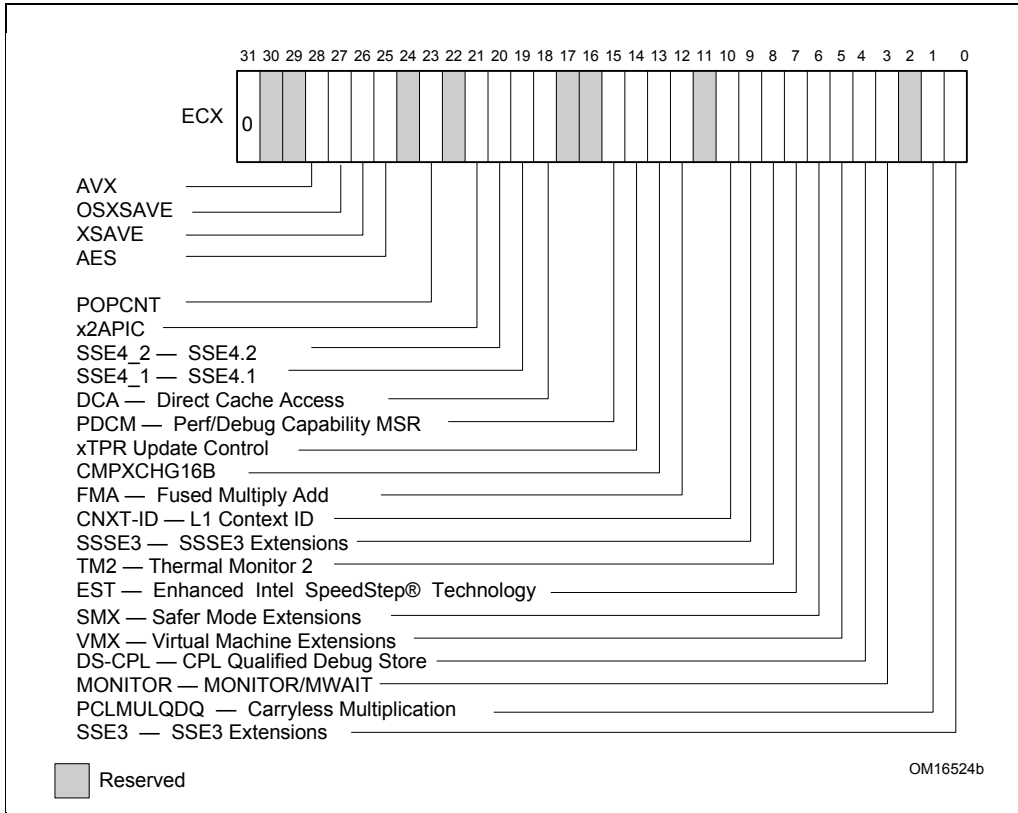

Figure 3-7. Feature Information Returned in the ECX Register

Table 3-23. Feature Information Returned in the ECX Register

Bit #	Mnemonic	Description
0	SSE3	Streaming SIMD Extensions 3 (SSE3). A value of 1 indicates the processor supports this technology.
1	PCLMULQDQ	PCLMULQDQ. A value of 1 indicates the processor supports the PCLMULQDQ instruction
2	DTES64	64-bit DS Area. A value of 1 indicates the processor supports DS area using 64-bit layout

Table 3-23. Feature Information Returned in the ECX Register (Contd.)

Bit #	Mnemonic	Description
3	MONITOR	MONITOR/MWAIT. A value of 1 indicates the processor supports this feature.
4	DS-CPL	CPL Qualified Debug Store. A value of 1 indicates the processor supports the extensions to the Debug Store feature to allow for branch message storage qualified by CPL.
5	VMX	Virtual Machine Extensions. A value of 1 indicates that the processor supports this technology
6	SMX	Safer Mode Extensions. A value of 1 indicates that the processor supports this technology. See Chapter 6, “Safer Mode Extensions Reference”.
7	EST	Enhanced Intel SpeedStep® technology. A value of 1 indicates that the processor supports this technology.
8	TM2	Thermal Monitor 2. A value of 1 indicates whether the processor supports this technology.
9	SSSE3	A value of 1 indicates the presence of the Supplemental Streaming SIMD Extensions 3 (SSSE3). A value of 0 indicates the instruction extensions are not present in the processor
10	CNXT-ID	L1 Context ID. A value of 1 indicates the L1 data cache mode can be set to either adaptive mode or shared mode. A value of 0 indicates this feature is not supported. See definition of the IA32_MISC_ENABLE MSR Bit 24 (L1 Data Cache Context Mode) for details.
11-12	Reserved	Reserved
13	CMPXCHG16B	CMPXCHG16B Available. A value of 1 indicates that the feature is available. See the “CMPXCHG8B/CMPXCHG16B—Compare and Exchange Bytes” section in this chapter for a description.
14	xTPR Update Control	xTPR Update Control. A value of 1 indicates that the processor supports changing IA32_MISC_ENABLES[bit 23].
15	PDCM	Perfmon and Debug Capability: A value of 1 indicates the processor supports the performance and debug feature indication MSR IA32_PERF_CAPABILITIES.
17 - 16	Reserved	Reserved
18	DCA	A value of 1 indicates the processor supports the ability to prefetch data from a memory mapped device.
19	SSE4.1	A value of 1 indicates that the processor supports SSE4.1.
20	SSE4.2	A value of 1 indicates that the processor supports SSE4.2.
21	x2APIC	A value of 1 indicates that the processor supports x2APIC feature.
22	MOVBE	A value of 1 indicates that the processor supports MOVBE instruction.

Table 3-23. Feature Information Returned in the ECX Register (Contd.)

Bit #	Mnemonic	Description
23	POPCNT	A value of 1 indicates that the processor supports the POPCNT instruction.
24	Reserved	Reserved
25	AES	A value of 1 indicates that the processor supports the AES instruction extensions.
26	XSAVE	A value of 1 indicates that the processor supports the XSAVE/XRSTOR processor extended states feature, the XSETBV/XGETBV instructions, and the XFEATURE_ENABLED_MASK register (XCRO).
27	OSXSAVE	A value of 1 indicates that the OS has enabled XSETBV/XGETBV instructions to access the XFEATURE_ENABLED_MASK register (XCRO), and support for processor extended state management using XSAVE/XRSTOR.
30 - 28	Reserved	Reserved
31	Not Used	Always return 0

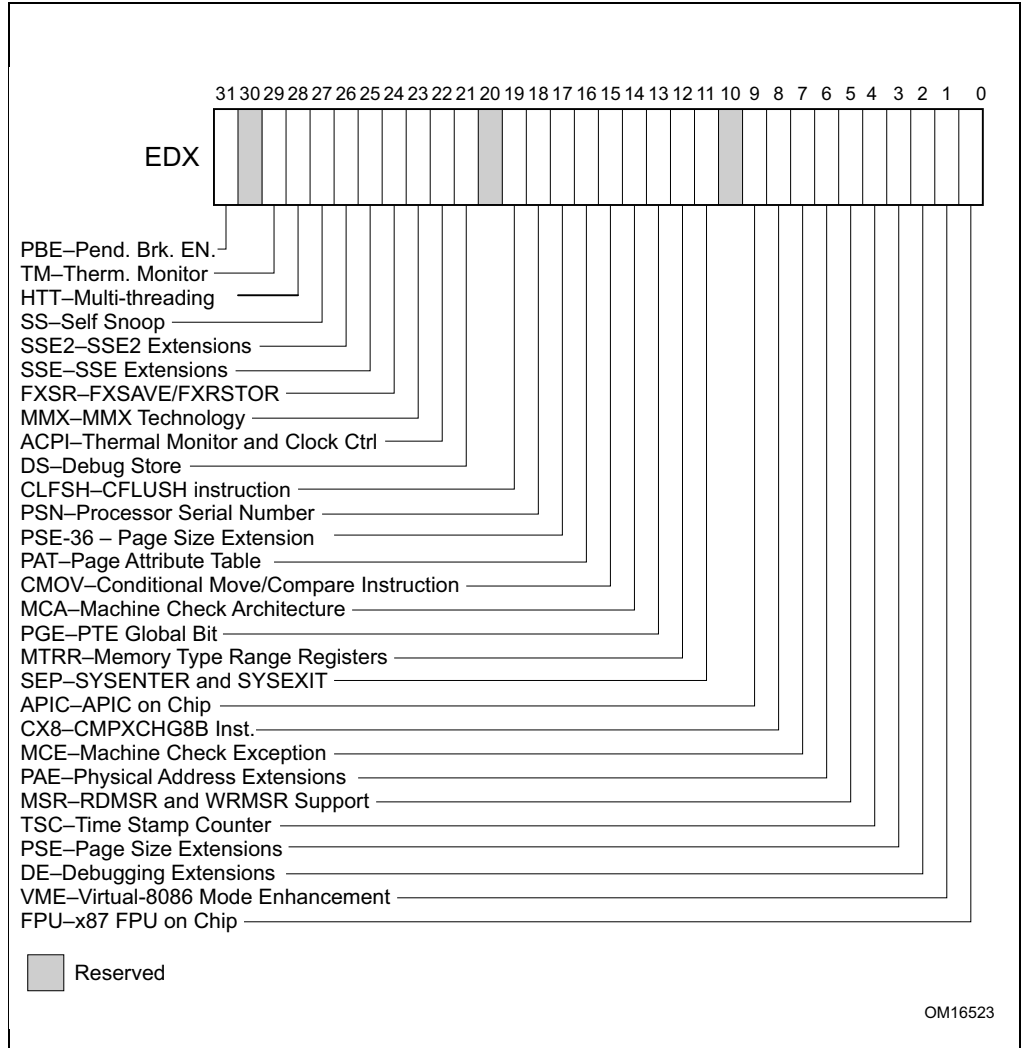

Figure 3-8. Feature Information Returned in the EDX Register

Table 3-24. More on Feature Information Returned in the EDX Register

Bit #	Mnemonic	Description
0	FPU	Floating Point Unit On-Chip. The processor contains an x87 FPU.
1	VME	Virtual 8086 Mode Enhancements. Virtual 8086 mode enhancements, including CR4.VME for controlling the feature, CR4.PVI for protected mode virtual interrupts, software interrupt indirection, expansion of the TSS with the software indirection bitmap, and EFLAGS.VIF and EFLAGS.VIP flags.
2	DE	Debugging Extensions. Support for I/O breakpoints, including CR4.DE for controlling the feature, and optional trapping of accesses to DR4 and DR5.
3	PSE	Page Size Extension. Large pages of size 4 MByte are supported, including CR4.PSE for controlling the feature, the defined dirty bit in PDE (Page Directory Entries), optional reserved bit trapping in CR3, PDEs, and PTEs.
4	TSC	Time Stamp Counter. The RDTSC instruction is supported, including CR4.TSD for controlling privilege.
5	MSR	Model Specific Registers RDMSR and WRMSR Instructions. The RDMSR and WRMSR instructions are supported. Some of the MSRs are implementation dependent.
6	PAE	Physical Address Extension. Physical addresses greater than 32 bits are supported: extended page table entry formats, an extra level in the page translation tables is defined, 2-MByte pages are supported instead of 4 Mbyte pages if PAE bit is 1.
7	MCE	Machine Check Exception. Exception 18 is defined for Machine Checks, including CR4.MCE for controlling the feature. This feature does not define the model-specific implementations of machine-check error logging, reporting, and processor shutdowns. Machine Check exception handlers may have to depend on processor version to do model specific processing of the exception, or test for the presence of the Machine Check feature.
8	CX8	CMPXCHG8B Instruction. The compare-and-exchange 8 bytes (64 bits) instruction is supported (implicitly locked and atomic).
9	APIC	APIC On-Chip. The processor contains an Advanced Programmable Interrupt Controller (APIC), responding to memory mapped commands in the physical address range FFFE0000H to FFFE0FFFH (by default - some processors permit the APIC to be relocated).
10	Reserved	Reserved
11	SEP	SYSENTER and SYSEXIT Instructions. The SYSENTER and SYSEXIT and associated MSRs are supported.
12	MTRR	Memory Type Range Registers. MTRRs are supported. The MTRRcap MSR contains feature bits that describe what memory types are supported, how many variable MTRRs are supported, and whether fixed MTRRs are supported.

Table 3-24. More on Feature Information Returned in the EDX Register (Contd.)

Bit #	Mnemonic	Description
13	PGE	Page Global Bit. The global bit is supported in paging-structure entries (PDEs and PTEs) that map a page, indicating TLB entries that are common to different processes and need not be flushed. The CR4.PGE bit controls this feature.
14	MCA	Machine Check Architecture. The Machine Check Architecture, which provides a compatible mechanism for error reporting in P6 family, Pentium 4, Intel Xeon processors, and future processors, is supported. The MCG_CAP MSR contains feature bits describing how many banks of error reporting MSRs are supported.
15	CMOV	Conditional Move Instructions. The conditional move instruction CMOV is supported. In addition, if x87 FPU is present as indicated by the CPUID.FPU feature bit, then the FCOMI and FCMOV instructions are supported
16	PAT	Page Attribute Table. Page Attribute Table is supported. This feature augments the Memory Type Range Registers (MTRRs), allowing an operating system to specify attributes of memory accessed through a linear address on a 4KB granularity.
17	PSE-36	36-Bit Page Size Extension. 4-MByte pages addressing physical memory beyond 4 GBytes are supported with 32-bit paging. This feature indicates that upper bits of the physical address of a 4-MByte page are encoded in bits 20:13 of the page-directory entry. Such physical addresses are limited by MAXPHYADDR and may be up to 40 bits in size.
18	PSN	Processor Serial Number. The processor supports the 96-bit processor identification number feature and the feature is enabled.
19	CLFSH	CLFLUSH Instruction. CLFLUSH Instruction is supported.
20	Reserved	Reserved
21	DS	Debug Store. The processor supports the ability to write debug information into a memory resident buffer. This feature is used by the branch trace store (BTS) and precise event-based sampling (PEBS) facilities (see Chapter 19, "Debugging and Performance Monitoring," in the <i>Intel® 64 and IA-32 Architectures Software Developer's Manual, Volume 3B</i>).
22	ACPI	Thermal Monitor and Software Controlled Clock Facilities. The processor implements internal MSRs that allow processor temperature to be monitored and processor performance to be modulated in predefined duty cycles under software control.
23	MMX	Intel MMX Technology. The processor supports the Intel MMX technology.

Table 3-24. More on Feature Information Returned in the EDX Register (Contd.)

Bit #	Mnemonic	Description
24	FXSR	FXSAVE and FXRSTOR Instructions. The FXSAVE and FXRSTOR instructions are supported for fast save and restore of the floating point context. Presence of this bit also indicates that CR4.OSFXSR is available for an operating system to indicate that it supports the FXSAVE and FXRSTOR instructions.
25	SSE	SSE. The processor supports the SSE extensions.
26	SSE2	SSE2. The processor supports the SSE2 extensions.
27	SS	Self Snoop. The processor supports the management of conflicting memory types by performing a snoop of its own cache structure for transactions issued to the bus.
28	HTT	Multi-Threading. The physical processor package is capable of supporting more than one logical processor.
29	TM	Thermal Monitor. The processor implements the thermal monitor automatic thermal control circuitry (TCC).
30	Reserved	Reserved
31	PBE	Pending Break Enable. The processor supports the use of the FERR#/PBE# pin when the processor is in the stop-clock state (STPCLK# is asserted) to signal the processor that an interrupt is pending and that the processor should return to normal operation to handle the interrupt. Bit 10 (PBE enable) in the IA32_MISC_ENABLE MSR enables this capability.

INPUT EAX = 2: TLB/Cache/Prefetch Information Returned in EAX, EBX, ECX, EDX

When CPUID executes with EAX set to 2, the processor returns information about the processor's internal TLBs, cache and prefetch hardware in the EAX, EBX, ECX, and EDX registers. The information is reported in encoded form and fall into the following categories:

- The least-significant byte in register EAX (register AL) indicates the number of times the CPUID instruction must be executed with an input value of 2 to get a complete description of the processor's TLB/Cache/Prefetch hardware. The Intel Xeon processor 7400 series will return a 1.
- The most significant bit (bit 31) of each register indicates whether the register contains valid information (set to 0) or is reserved (set to 1).
- If a register contains valid information, the information is contained in 1 byte descriptors. There are four types of encoding values for the byte descriptor, the encoding type is noted in the second column of Table 3-25. Table 3-25 lists the encoding of these descriptors. Note that the order of descriptors in the EAX, EBX, ECX, and EDX registers is not defined; that is, specific bytes are not designated to contain descriptors for specific cache, prefetch, or TLB types. The descriptors

may appear in any order. Note also a processor may report a general descriptor type (FFH) and not report any byte descriptor of “cache type” via CPUID leaf 2.

Table 3-25. Encoding of CPUID Leaf 2 Descriptors

Value	Type	Description
00H	General	Null descriptor, this byte contains no information
01H	TLB	Instruction TLB: 4 KByte pages, 4-way set associative, 32 entries
02H	TLB	Instruction TLB: 4 MByte pages, fully associative, 2 entries
03H	TLB	Data TLB: 4 KByte pages, 4-way set associative, 64 entries
04H	TLB	Data TLB: 4 MByte pages, 4-way set associative, 8 entries
05H	TLB	Data TLB1: 4 MByte pages, 4-way set associative, 32 entries
06H	Cache	1st-level instruction cache: 8 KBytes, 4-way set associative, 32 byte line size
08H	Cache	1st-level instruction cache: 16 KBytes, 4-way set associative, 32 byte line size
09H	Cache	1st-level instruction cache: 32KBytes, 4-way set associative, 64 byte line size
0AH	Cache	1st-level data cache: 8 KBytes, 2-way set associative, 32 byte line size
0BH	TLB	Instruction TLB: 4 MByte pages, 4-way set associative, 4 entries
0CH	Cache	1st-level data cache: 16 KBytes, 4-way set associative, 32 byte line size
0DH	Cache	1st-level data cache: 16 KBytes, 4-way set associative, 64 byte line size
0EH	Cache	1st-level data cache: 24 KBytes, 6-way set associative, 64 byte line size
21H	Cache	2nd-level cache: 256 KBytes, 8-way set associative, 64 byte line size
22H	Cache	3rd-level cache: 512 KBytes, 4-way set associative, 64 byte line size, 2 lines per sector
23H	Cache	3rd-level cache: 1 MBytes, 8-way set associative, 64 byte line size, 2 lines per sector
25H	Cache	3rd-level cache: 2 MBytes, 8-way set associative, 64 byte line size, 2 lines per sector
29H	Cache	3rd-level cache: 4 MBytes, 8-way set associative, 64 byte line size, 2 lines per sector
2CH	Cache	1st-level data cache: 32 KBytes, 8-way set associative, 64 byte line size
30H	Cache	1st-level instruction cache: 32 KBytes, 8-way set associative, 64 byte line size
40H	Cache	No 2nd-level cache or, if processor contains a valid 2nd-level cache, no 3rd-level cache
41H	Cache	2nd-level cache: 128 KBytes, 4-way set associative, 32 byte line size
42H	Cache	2nd-level cache: 256 KBytes, 4-way set associative, 32 byte line size
43H	Cache	2nd-level cache: 512 KBytes, 4-way set associative, 32 byte line size
44H	Cache	2nd-level cache: 1 MByte, 4-way set associative, 32 byte line size

Table 3-25. Encoding of CPUID Leaf 2 Descriptors (Contd.)

Value	Type	Description
45H	Cache	2nd-level cache: 2 MByte, 4-way set associative, 32 byte line size
46H	Cache	3rd-level cache: 4 MByte, 4-way set associative, 64 byte line size
47H	Cache	3rd-level cache: 8 MByte, 8-way set associative, 64 byte line size
48H	Cache	2nd-level cache: 3MByte, 12-way set associative, 64 byte line size
49H	Cache	3rd-level cache: 4MB, 16-way set associative, 64-byte line size (Intel Xeon processor MP, Family OFH, Model 06H); 2nd-level cache: 4 MByte, 16-way set associative, 64 byte line size
4AH	Cache	3rd-level cache: 6MByte, 12-way set associative, 64 byte line size
4BH	Cache	3rd-level cache: 8MByte, 16-way set associative, 64 byte line size
4CH	Cache	3rd-level cache: 12MByte, 12-way set associative, 64 byte line size
4DH	Cache	3rd-level cache: 16MByte, 16-way set associative, 64 byte line size
4EH	Cache	2nd-level cache: 6MByte, 24-way set associative, 64 byte line size
4FH	TLB	Instruction TLB: 4 KByte pages, 32 entries
50H	TLB	Instruction TLB: 4 KByte and 2-MByte or 4-MByte pages, 64 entries
51H	TLB	Instruction TLB: 4 KByte and 2-MByte or 4-MByte pages, 128 entries
52H	TLB	Instruction TLB: 4 KByte and 2-MByte or 4-MByte pages, 256 entries
55H	TLB	Instruction TLB: 2-MByte or 4-MByte pages, fully associative, 7 entries
56H	TLB	Data TLB0: 4 MByte pages, 4-way set associative, 16 entries
57H	TLB	Data TLB0: 4 KByte pages, 4-way associative, 16 entries
59H	TLB	Data TLB0: 4 KByte pages, fully associative, 16 entries
5AH	TLB	Data TLB0: 2-MByte or 4 MByte pages, 4-way set associative, 32 entries
5BH	TLB	Data TLB: 4 KByte and 4 MByte pages, 64 entries
5CH	TLB	Data TLB: 4 KByte and 4 MByte pages, 128 entries
5DH	TLB	Data TLB: 4 KByte and 4 MByte pages, 256 entries
60H	Cache	1st-level data cache: 16 KByte, 8-way set associative, 64 byte line size
66H	Cache	1st-level data cache: 8 KByte, 4-way set associative, 64 byte line size
67H	Cache	1st-level data cache: 16 KByte, 4-way set associative, 64 byte line size
68H	Cache	1st-level data cache: 32 KByte, 4-way set associative, 64 byte line size
70H	Cache	Trace cache: 12 K- μ op, 8-way set associative
71H	Cache	Trace cache: 16 K- μ op, 8-way set associative
72H	Cache	Trace cache: 32 K- μ op, 8-way set associative
78H	Cache	2nd-level cache: 1 MByte, 4-way set associative, 64byte line size

Table 3-25. Encoding of CPUID Leaf 2 Descriptors (Contd.)

Value	Type	Description
79H	Cache	2nd-level cache: 128 KByte, 8-way set associative, 64 byte line size, 2 lines per sector
7AH	Cache	2nd-level cache: 256 KByte, 8-way set associative, 64 byte line size, 2 lines per sector
7BH	Cache	2nd-level cache: 512 KByte, 8-way set associative, 64 byte line size, 2 lines per sector
7CH	Cache	2nd-level cache: 1 MByte, 8-way set associative, 64 byte line size, 2 lines per sector
7DH	Cache	2nd-level cache: 2 MByte, 8-way set associative, 64byte line size
7FH	Cache	2nd-level cache: 512 KByte, 2-way set associative, 64-byte line size
80H	Cache	2nd-level cache: 512 KByte, 8-way set associative, 64-byte line size
82H	Cache	2nd-level cache: 256 KByte, 8-way set associative, 32 byte line size
83H	Cache	2nd-level cache: 512 KByte, 8-way set associative, 32 byte line size
84H	Cache	2nd-level cache: 1 MByte, 8-way set associative, 32 byte line size
85H	Cache	2nd-level cache: 2 MByte, 8-way set associative, 32 byte line size
86H	Cache	2nd-level cache: 512 KByte, 4-way set associative, 64 byte line size
87H	Cache	2nd-level cache: 1 MByte, 8-way set associative, 64 byte line size
B0H	TLB	Instruction TLB: 4 KByte pages, 4-way set associative, 128 entries
B1H	TLB	Instruction TLB: 2M pages, 4-way, 8 entries or 4M pages, 4-way, 4 entries
B2H	TLB	Instruction TLB: 4KByte pages, 4-way set associative, 64 entries
B3H	TLB	Data TLB: 4 KByte pages, 4-way set associative, 128 entries
B4H	TLB	Data TLB1: 4 KByte pages, 4-way associative, 256 entries
BAH	TLB	Data TLB1: 4 KByte pages, 4-way associative, 64 entries
C0H	TLB	Data TLB: 4 KByte and 4 MByte pages, 4-way associative, 8 entries
CAH	STLB	Shared 2nd-Level TLB: 4 KByte pages, 4-way associative, 512 entries
E4H	Cache	3rd-level cache: 8 MByte, 16-way set associative, 64 byte line size
F0H	Prefetch	64-Byte prefetching
F1H	Prefetch	128-Byte prefetching
FFH	General	CPUID leaf 2 does not report cache descriptor information, use CPUID leaf 4 to query cache parameters

Example 3-1. Example of Cache and TLB Interpretation

The first member of the family of Pentium 4 processors returns the following information about caches and TLBs when the CPUID executes with an input value of 2:

```

EAX    66 5B 50 01H
EBX    0H
ECX    0H
EDX    00 7A 70 00H

```

Which means:

- The least-significant byte (byte 0) of register EAX is set to 01H. This indicates that CPUID needs to be executed once with an input value of 2 to retrieve complete information about caches and TLBs.
- The most-significant bit of all four registers (EAX, EBX, ECX, and EDX) is set to 0, indicating that each register contains valid 1-byte descriptors.
- Bytes 1, 2, and 3 of register EAX indicate that the processor has:
 - 50H - a 64-entry instruction TLB, for mapping 4-KByte and 2-MByte or 4-MByte pages.
 - 5BH - a 64-entry data TLB, for mapping 4-KByte and 4-MByte pages.
 - 66H - an 8-KByte 1st level data cache, 4-way set associative, with a 64-Byte cache line size.
- The descriptors in registers EBX and ECX are valid, but contain NULL descriptors.
- Bytes 0, 1, 2, and 3 of register EDX indicate that the processor has:
 - 00H - NULL descriptor.
 - 70H - Trace cache: 12 K- μ op, 8-way set associative.
 - 7AH - a 256-KByte 2nd level cache, 8-way set associative, with a sectored, 64-byte cache line size.
 - 00H - NULL descriptor.

INPUT EAX = 4: Returns Deterministic Cache Parameters for Each Level

When CPUID executes with EAX set to 4 and ECX contains an index value, the processor returns encoded data that describe a set of deterministic cache parameters (for the cache level associated with the input in ECX). Valid index values start from 0.

Software can enumerate the deterministic cache parameters for each level of the cache hierarchy starting with an index value of 0, until the parameters report the value associated with the cache type field is 0. The architecturally defined fields reported by deterministic cache parameters are documented in Table 3-20.

The CPUID leaf 4 also reports data that can be used to derive the topology of processor cores in a physical package. This information is constant for all valid index values. Software can query the raw data reported by executing CPUID with EAX=4 and ECX=0 and use it as part of the topology enumeration algorithm described in Chapter 8, "Multiple-Processor Management," in the *Intel® 64 and IA-32 Architectures Software Developer's Manual, Volume 3A*.

INPUT EAX = 5: Returns MONITOR and MWAIT Features

When CPUID executes with EAX set to 5, the processor returns information about features available to MONITOR/MWAIT instructions. The MONITOR instruction is used for address-range monitoring in conjunction with MWAIT instruction. The MWAIT instruction optionally provides additional extensions for advanced power management. See Table 3-20.

INPUT EAX = 6: Returns Thermal and Power Management Features

When CPUID executes with EAX set to 6, the processor returns information about thermal and power management features. See Table 3-20.

INPUT EAX = 9: Returns Direct Cache Access Information

When CPUID executes with EAX set to 9, the processor returns information about Direct Cache Access capabilities. See Table 3-20.

INPUT EAX = 10: Returns Architectural Performance Monitoring Features

When CPUID executes with EAX set to 10, the processor returns information about support for architectural performance monitoring capabilities. Architectural performance monitoring is supported if the version ID (see Table 3-20) is greater than Pn 0. See Table 3-20.

For each version of architectural performance monitoring capability, software must enumerate this leaf to discover the programming facilities and the architectural performance events available in the processor. The details are described in Chapter 19, “Debugging and Performance Monitoring,” in the *Intel® 64 and IA-32 Architectures Software Developer’s Manual, Volume 3B*.

INPUT EAX = 11: Returns Extended Topology Information

When CPUID executes with EAX set to 11, the processor returns information about extended topology enumeration data. Software must detect the presence of CPUID leaf 0BH by verifying (a) the highest leaf index supported by CPUID is $\geq 0BH$, and (b) CPUID.0BH:EBX[15:0] reports a non-zero value.

INPUT EAX = 13: Returns Processor Extended States Enumeration Information

When CPUID executes with EAX set to 13 and ECX = 0, the processor returns information about the bit-vector representation of all processor state extensions that are supported in the processor and storage size requirements of the XSAVE/XRSTOR area. See Table 3-20.

When CPUID executes with EAX set to 13 and ECX = n (n > 1, and is a valid sub-leaf index), the processor returns information about the size and offset of each processor extended state save area within the XSAVE/XRSTOR area. See Table 3-20. Software can use the forward-extendable technique depicted below to query the valid sub-

leaves and obtain size and offset information for each processor extended state save area:

```
For i = 2 to 62 // sub-leaf 1 is reserved
  IF (CPUID.(EAX=0DH, ECX=0):VECTOR[i] = 1 ) // VECTOR is the 64-bit value of EDX:EAX
    Execute CPUID.(EAX=0DH, ECX = i) to examine size and offset for sub-leaf i;
  FI;
```

METHODS FOR RETURNING BRANDING INFORMATION

Use the following techniques to access branding information:

1. Processor brand string method; this method also returns the processor's maximum operating frequency
2. Processor brand index; this method uses a software supplied brand string table.

These two methods are discussed in the following sections. For methods that are available in early processors, see Section: "Identification of Earlier IA-32 Processors" in Chapter 14 of the *Intel® 64 and IA-32 Architectures Software Developer's Manual, Volume 1*.

The Processor Brand String Method

Figure 3-9 describes the algorithm used for detection of the brand string. Processor brand identification software should execute this algorithm on all Intel 64 and IA-32 processors.

This method (introduced with Pentium 4 processors) returns an ASCII brand identification string and the maximum operating frequency of the processor to the EAX, EBX, ECX, and EDX registers.

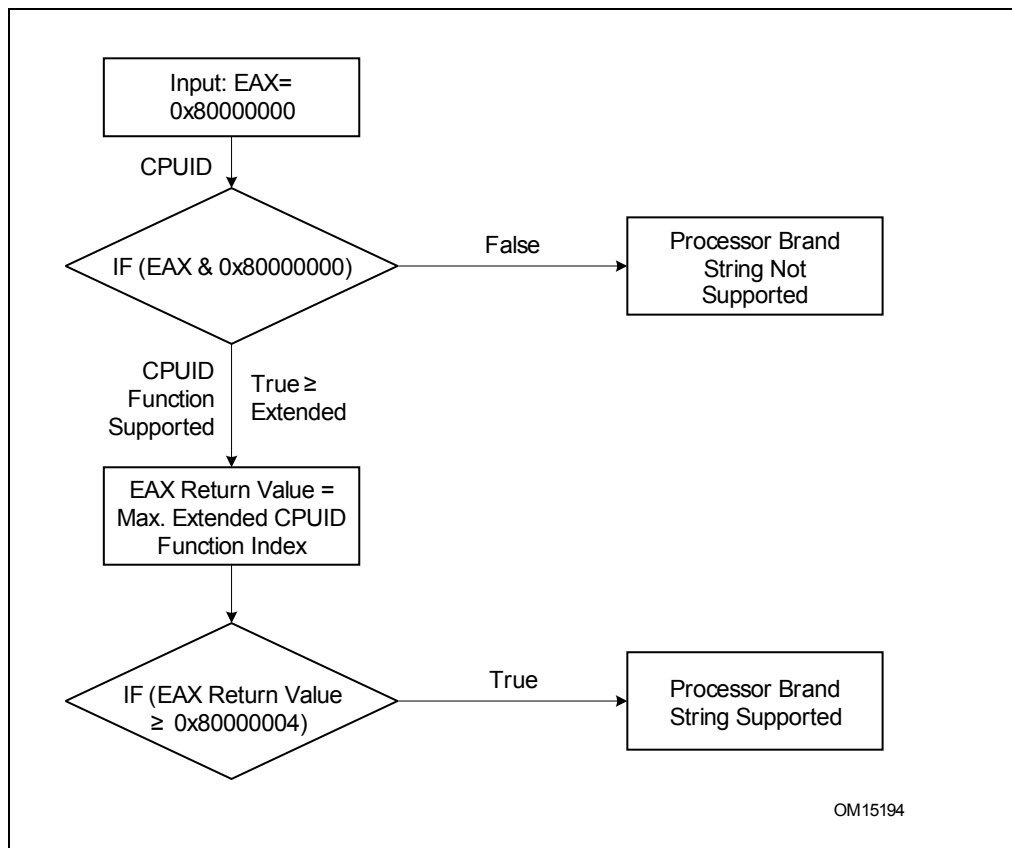

Figure 3-9. Determination of Support for the Processor Brand String

How Brand Strings Work

To use the brand string method, execute CPUID with EAX input of 8000002H through 80000004H. For each input value, CPUID returns 16 ASCII characters using EAX, EBX, ECX, and EDX. The returned string will be NULL-terminated.

Table 3-26 shows the brand string that is returned by the first processor in the Pentium 4 processor family.

Table 3-26. Processor Brand String Returned with Pentium 4 Processor

EAX Input Value	Return Values	ASCII Equivalent
-----------------	---------------	------------------

Table 3-26. Processor Brand String Returned with Pentium 4 Processor (Contd.)

80000002H	EAX = 20202020H EBX = 20202020H ECX = 20202020H EDX = 6E492020H	" " " " " " "nl "
80000003H	EAX = 286C6574H EBX = 50202952H ECX = 69746E65H EDX = 52286D75H	"(let" "P)R" "itne" "R(mu"
80000004H	EAX = 20342029H EBX = 20555043H ECX = 30303531H EDX = 007A484DH	" 4)" " UPC" "0051" "0zHM"

Extracting the Maximum Processor Frequency from Brand Strings

Figure 3-10 provides an algorithm which software can use to extract the maximum processor operating frequency from the processor brand string.

NOTE

When a frequency is given in a brand string, it is the maximum qualified frequency of the processor, not the frequency at which the processor is currently running.

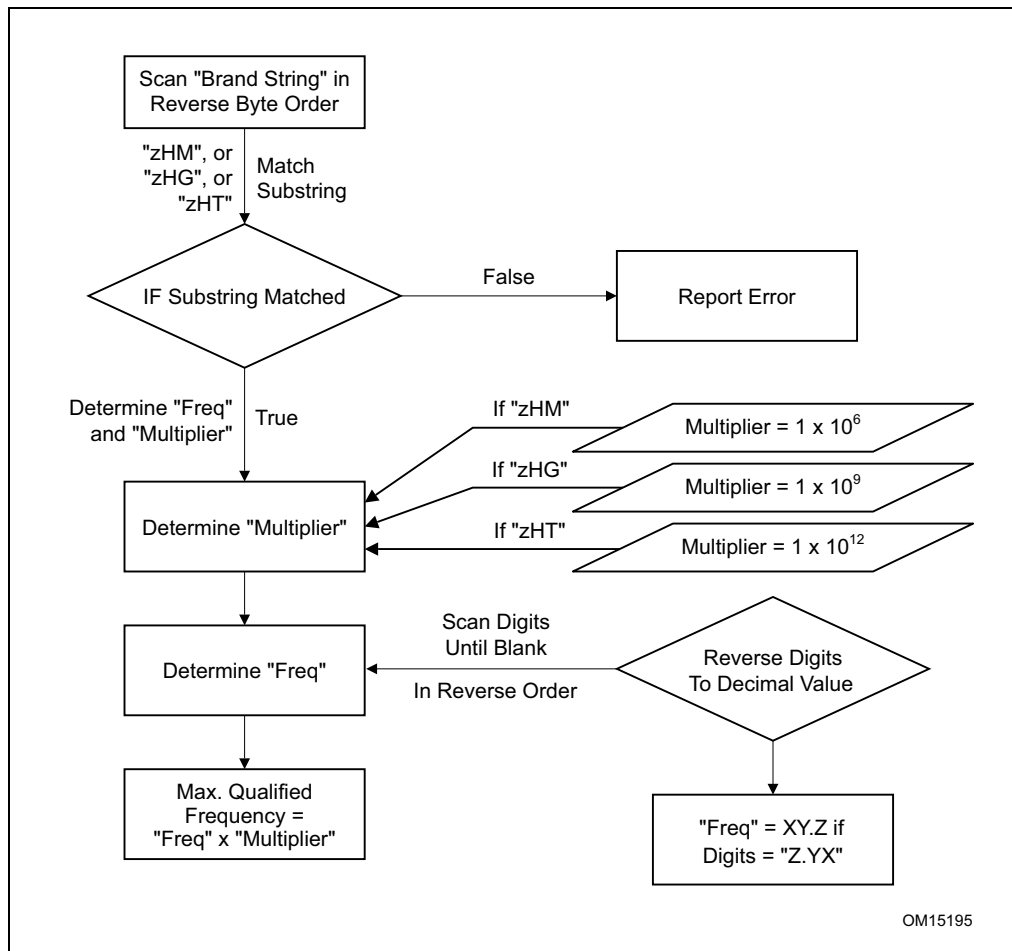

Figure 3-10. Algorithm for Extracting Maximum Processor Frequency

The Processor Brand Index Method

The brand index method (introduced with Pentium® III Xeon® processors) provides an entry point into a brand identification table that is maintained in memory by system software and is accessible from system- and user-level code. In this table, each brand index is associated with an ASCII brand identification string that identifies the official Intel family and model number of a processor.

When CPUID executes with EAX set to 1, the processor returns a brand index to the low byte in EBX. Software can then use this index to locate the brand identification string for the processor in the brand identification table. The first entry (brand index 0) in this table is reserved, allowing for backward compatibility with processors that

do not support the brand identification feature. Starting with processor signature family ID = 0FH, model = 03H, brand index method is no longer supported. Use brand string method instead.

Table 3-27 shows brand indices that have identification strings associated with them.

Table 3-27. Mapping of Brand Indices; and Intel 64 and IA-32 Processor Brand Strings

Brand Index	Brand String
00H	This processor does not support the brand identification feature
01H	Intel(R) Celeron(R) processor ¹
02H	Intel(R) Pentium(R) III processor ¹
03H	Intel(R) Pentium(R) III Xeon(R) processor; If processor signature = 000006B1h, then Intel(R) Celeron(R) processor
04H	Intel(R) Pentium(R) III processor
06H	Mobile Intel(R) Pentium(R) III processor-M
07H	Mobile Intel(R) Celeron(R) processor ¹
08H	Intel(R) Pentium(R) 4 processor
09H	Intel(R) Pentium(R) 4 processor
0AH	Intel(R) Celeron(R) processor ¹
0BH	Intel(R) Xeon(R) processor; If processor signature = 00000F13h, then Intel(R) Xeon(R) processor MP
0CH	Intel(R) Xeon(R) processor MP
0EH	Mobile Intel(R) Pentium(R) 4 processor-M; If processor signature = 00000F13h, then Intel(R) Xeon(R) processor
0FH	Mobile Intel(R) Celeron(R) processor ¹
11H	Mobile Genuine Intel(R) processor
12H	Intel(R) Celeron(R) M processor
13H	Mobile Intel(R) Celeron(R) processor ¹
14H	Intel(R) Celeron(R) processor
15H	Mobile Genuine Intel(R) processor
16H	Intel(R) Pentium(R) M processor
17H	Mobile Intel(R) Celeron(R) processor ¹
18H – 0FFH	RESERVED

NOTES:

1. Indicates versions of these processors that were introduced after the Pentium III

IA-32 Architecture Compatibility

CPUID is not supported in early models of the Intel486 processor or in any IA-32 processor earlier than the Intel486 processor.

Operation

IA32_BIOS_SIGN_ID MSR ← Update with installed microcode revision number;

CASE (EAX) OF

EAX = 0:

EAX ← Highest basic function input value understood by CPUID;

EBX ← Vendor identification string;

EDX ← Vendor identification string;

ECX ← Vendor identification string;

BREAK;

EAX = 1H:

EAX[3:0] ← Stepping ID;

EAX[7:4] ← Model;

EAX[11:8] ← Family;

EAX[13:12] ← Processor type;

EAX[15:14] ← Reserved;

EAX[19:16] ← Extended Model;

EAX[27:20] ← Extended Family;

EAX[31:28] ← Reserved;

EBX[7:0] ← Brand Index; (* Reserved if the value is zero. *)

EBX[15:8] ← CLFLUSH Line Size;

EBX[16:23] ← Reserved; (* Number of threads enabled = 2 if MT enable fuse set. *)

EBX[24:31] ← Initial APIC ID;

ECX ← Feature flags; (* See Figure 3-7. *)

EDX ← Feature flags; (* See Figure 3-8. *)

BREAK;

EAX = 2H:

EAX ← Cache and TLB information;

EBX ← Cache and TLB information;

ECX ← Cache and TLB information;

EDX ← Cache and TLB information;

BREAK;

EAX = 3H:

EAX ← Reserved;

EBX ← Reserved;

ECX ← ProcessorSerialNumber[31:0];

(* Pentium III processors only, otherwise reserved. *)

EDX ← ProcessorSerialNumber[63:32];

(* Pentium III processors only, otherwise reserved. *)

BREAK

EAX = 4H:

EAX ← Deterministic Cache Parameters Leaf; (* See Table 3-20. *)
 EBX ← Deterministic Cache Parameters Leaf;
 ECX ← Deterministic Cache Parameters Leaf;
 EDX ← Deterministic Cache Parameters Leaf;

BREAK;

EAX = 5H:

EAX ← MONITOR/MWAIT Leaf; (* See Table 3-20. *)
 EBX ← MONITOR/MWAIT Leaf;
 ECX ← MONITOR/MWAIT Leaf;
 EDX ← MONITOR/MWAIT Leaf;

BREAK;

EAX = 6H:

EAX ← Thermal and Power Management Leaf; (* See Table 3-20. *)
 EBX ← Thermal and Power Management Leaf;
 ECX ← Thermal and Power Management Leaf;
 EDX ← Thermal and Power Management Leaf;

BREAK;

EAX = 7H or 8H:

EAX ← Reserved = 0;
 EBX ← Reserved = 0;
 ECX ← Reserved = 0;
 EDX ← Reserved = 0;

BREAK;

EAX = 9H:

EAX ← Direct Cache Access Information Leaf; (* See Table 3-20. *)
 EBX ← Direct Cache Access Information Leaf;
 ECX ← Direct Cache Access Information Leaf;
 EDX ← Direct Cache Access Information Leaf;

BREAK;

EAX = AH:

EAX ← Architectural Performance Monitoring Leaf; (* See Table 3-20. *)
 EBX ← Architectural Performance Monitoring Leaf;
 ECX ← Architectural Performance Monitoring Leaf;
 EDX ← Architectural Performance Monitoring Leaf;
 BREAK

EAX = BH:

EAX ← Extended Topology Enumeration Leaf; (* See Table 3-20. *)
 EBX ← Extended Topology Enumeration Leaf;
 ECX ← Extended Topology Enumeration Leaf;
 EDX ← Extended Topology Enumeration Leaf;

BREAK;

EAX = CH:

EAX ← Reserved = 0;

EBX ← Reserved = 0;

ECX ← Reserved = 0;

EDX ← Reserved = 0;

BREAK;

EAX = DH:

EAX ← Processor Extended State Enumeration Leaf; (* See Table 3-20. *)

EBX ← Processor Extended State Enumeration Leaf;

ECX ← Processor Extended State Enumeration Leaf;

EDX ← Processor Extended State Enumeration Leaf;

BREAK;

BREAK;

EAX = 80000000H:

EAX ← Highest extended function input value understood by CPUID;

EBX ← Reserved;

ECX ← Reserved;

EDX ← Reserved;

BREAK;

EAX = 80000001H:

EAX ← Reserved;

EBX ← Reserved;

ECX ← Extended Feature Bits (* See Table 3-20.*);

EDX ← Extended Feature Bits (* See Table 3-20. *);

BREAK;

EAX = 80000002H:

EAX ← Processor Brand String;

EBX ← Processor Brand String, continued;

ECX ← Processor Brand String, continued;

EDX ← Processor Brand String, continued;

BREAK;

EAX = 80000003H:

EAX ← Processor Brand String, continued;

EBX ← Processor Brand String, continued;

ECX ← Processor Brand String, continued;

EDX ← Processor Brand String, continued;

BREAK;

EAX = 80000004H:

EAX ← Processor Brand String, continued;

EBX ← Processor Brand String, continued;

ECX ← Processor Brand String, continued;

EDX ← Processor Brand String, continued;

BREAK;

EAX = 80000005H:

EAX ← Reserved = 0;
 EBX ← Reserved = 0;
 ECX ← Reserved = 0;
 EDX ← Reserved = 0;

BREAK;

EAX = 80000006H:

EAX ← Reserved = 0;
 EBX ← Reserved = 0;
 ECX ← Cache information;
 EDX ← Reserved = 0;

BREAK;

EAX = 80000007H:

EAX ← Reserved = 0;
 EBX ← Reserved = 0;
 ECX ← Reserved = 0;
 EDX ← Reserved = Misc Feature Flags;

BREAK;

EAX = 80000008H:

EAX ← Reserved = Physical Address Size Information;
 EBX ← Reserved = Virtual Address Size Information;
 ECX ← Reserved = 0;
 EDX ← Reserved = 0;

BREAK;

EAX >= 40000000H and EAX <= 4FFFFFFFH:

DEFAULT: (* EAX = Value outside of recognized range for CPUID. *)

(* If the highest basic information leaf data depend on ECX input value, ECX is honored. *)

EAX ← Reserved; (* Information returned for highest basic information leaf. *)
 EBX ← Reserved; (* Information returned for highest basic information leaf. *)
 ECX ← Reserved; (* Information returned for highest basic information leaf. *)
 EDX ← Reserved; (* Information returned for highest basic information leaf. *)

BREAK;

ESAC;

Flags Affected

None.

Exceptions (All Operating Modes)

#UD	If the LOCK prefix is used. In earlier IA-32 processors that do not support the CPUID instruction, execution of the instruction results in an invalid opcode (#UD) exception being generated.
-----	------------------------------------------------------------------------------------------------------------------------------------------------------------------------------------------------------

CRC32 — Accumulate CRC32 Value

Opcode	Instruction	64-bit Mode	Compat/Leg Mode	Description
F2 0F 38 F0 /r	CRC32 r32, r/m8	Valid	Valid	Accumulate CRC32 on r/m8.
F2 REX 0F 38 F0 /r	CRC32 r32, r/m8*	Valid	N.E.	Accumulate CRC32 on r/m8.
F2 0F 38 F1 /r	CRC32 r32, r/m16	Valid	Valid	Accumulate CRC32 on r/m16.
F2 0F 38 F1 /r	CRC32 r32, r/m32	Valid	Valid	Accumulate CRC32 on r/m32.
F2 REX.W 0F 38 F0 /r	CRC32 r64, r/m8	Valid	N.E.	Accumulate CRC32 on r/m8.
F2 REX.W 0F 38 F1 /r	CRC32 r64, r/m64	Valid	N.E.	Accumulate CRC32 on r/m64.

NOTES:

* In 64-bit mode, r/m8 can not be encoded to access the following byte registers if a REX prefix is used: AH, BH, CH, DH.

Description

Starting with an initial value in the first operand (destination operand), accumulates a CRC32 (polynomial 0x11EDC6F41) value for the second operand (source operand) and stores the result in the destination operand. The source operand can be a register or a memory location. The destination operand must be an r32 or r64 register. If the destination is an r64 register, then the 32-bit result is stored in the least significant double word and 00000000H is stored in the most significant double word of the r64 register.

The initial value supplied in the destination operand is a double word integer stored in the r32 register or the least significant double word of the r64 register. To incrementally accumulate a CRC32 value, software retains the result of the previous CRC32 operation in the destination operand, then executes the CRC32 instruction again with new input data in the source operand. Data contained in the source operand is processed in reflected bit order. This means that the most significant bit of the source operand is treated as the least significant bit of the quotient, and so on, for all the bits of the source operand. Likewise, the result of the CRC operation is stored in the destination operand in reflected bit order. This means that the most significant bit of the resulting CRC (bit 31) is stored in the least significant bit of the destination operand (bit 0), and so on, for all the bits of the CRC.

Operation

Notes:

BIT_REFLECT64: DST[63-0] = SRC[0-63]
 BIT_REFLECT32: DST[31-0] = SRC[0-31]
 BIT_REFLECT16: DST[15-0] = SRC[0-15]
 BIT_REFLECT8: DST[7-0] = SRC[0-7]
 MOD2: Remainder from Polynomial division modulus 2

CRC32 instruction for 64-bit source operand and 64-bit destination operand:

TEMP1[63-0] ← BIT_REFLECT64 (SRC[63-0])
 TEMP2[31-0] ← BIT_REFLECT32 (DEST[31-0])
 TEMP3[95-0] ← TEMP1[63-0] << 32
 TEMP4[95-0] ← TEMP2[31-0] << 64
 TEMP5[95-0] ← TEMP3[95-0] XOR TEMP4[95-0]
 TEMP6[31-0] ← TEMP5[95-0] MOD2 11EDC6F41H
 DEST[31-0] ← BIT_REFLECT (TEMP6[31-0])
 DEST[63-32] ← 00000000H

CRC32 instruction for 32-bit source operand and 32-bit destination operand:

TEMP1[31-0] ← BIT_REFLECT32 (SRC[31-0])
 TEMP2[31-0] ← BIT_REFLECT32 (DEST[31-0])
 TEMP3[63-0] ← TEMP1[31-0] << 32
 TEMP4[63-0] ← TEMP2[31-0] << 32
 TEMP5[63-0] ← TEMP3[63-0] XOR TEMP4[63-0]
 TEMP6[31-0] ← TEMP5[63-0] MOD2 11EDC6F41H
 DEST[31-0] ← BIT_REFLECT (TEMP6[31-0])

CRC32 instruction for 16-bit source operand and 32-bit destination operand:

TEMP1[15-0] ← BIT_REFLECT16 (SRC[15-0])
 TEMP2[31-0] ← BIT_REFLECT32 (DEST[31-0])
 TEMP3[47-0] ← TEMP1[15-0] << 32
 TEMP4[47-0] ← TEMP2[31-0] << 16
 TEMP5[47-0] ← TEMP3[47-0] XOR TEMP4[47-0]
 TEMP6[31-0] ← TEMP5[47-0] MOD2 11EDC6F41H
 DEST[31-0] ← BIT_REFLECT (TEMP6[31-0])

CRC32 instruction for 8-bit source operand and 64-bit destination operand:

TEMP1[7-0] ← BIT_REFLECT8 (SRC[7-0])
 TEMP2[31-0] ← BIT_REFLECT32 (DEST[31-0])
 TEMP3[39-0] ← TEMP1[7-0] << 32
 TEMP4[39-0] ← TEMP2[31-0] << 8
 TEMP5[39-0] ← TEMP3[39-0] XOR TEMP4[39-0]

```

TEMP6[31-0] ← TEMP5[39-0] MOD2 11EDC6F41H
DEST[31-0] ← BIT_REFLECT (TEMP6[31-0])
DEST[63-32] ← 00000000H

```

CRC32 instruction for 8-bit source operand and 32-bit destination operand:

```

TEMP1[7-0] ← BIT_REFLECT8(SRC[7-0])
TEMP2[31-0] ← BIT_REFLECT32 (DEST[31-0])
TEMP3[39-0] ← TEMP1[7-0] << 32
TEMP4[39-0] ← TEMP2[31-0] << 8
TEMP5[39-0] ← TEMP3[39-0] XOR TEMP4[39-0]
TEMP6[31-0] ← TEMP5[39-0] MOD2 11EDC6F41H
DEST[31-0] ← BIT_REFLECT (TEMP6[31-0])

```

Flags Affected

None

Intel C/C++ Compiler Intrinsic Equivalent

```

unsigned int _mm_crc32_u8( unsigned int crc, unsigned char data )
unsigned int _mm_crc32_u16( unsigned int crc, unsigned short data )
unsigned int _mm_crc32_u32( unsigned int crc, unsigned int data )
unsigned __int64 _mm_crc32_u64( unsigned __int64 crc, unsigned __int64 data )

```

SIMD Floating Point Exceptions

None

Protected Mode Exceptions

#GP(0)	If a memory operand effective address is outside the CS, DS, ES, FS or GS segments.
#SS(0)	If a memory operand effective address is outside the SS segment limit.
#PF (fault-code)	For a page fault.
#UD	If CPUID.01H: ECX.SSE4_2 [Bit 20] = 0. If LOCK prefix is used. If REP (F3H) prefix is used.

Real Mode Exceptions

#GP(0)	If any part of the operand lies outside of the effective address space from 0 to 0FFFFH.
#SS(0)	If a memory operand effective address is outside the SS segment limit.
#UD	If CPUID.01H: ECX.SSE4_2 [Bit 20] = 0.

If LOCK prefix is used.
 If REP (F3H) prefix is used.

Virtual 8086 Mode Exceptions

#GP(0)	If any part of the operand lies outside of the effective address space from 0 to 0FFFFH.
#SS(0)	If a memory operand effective address is outside the SS segment limit.
#PF (fault-code)	For a page fault.
#UD	If CPUID.01H: ECX.SSE4_2 [Bit 20] = 0. If LOCK prefix is used. If REP (F3H) prefix is used.

Compatibility Mode Exceptions

Same exceptions as in Protected Mode.

64-Bit Mode Exceptions

#GP(0)	If the memory address is in a non-canonical form.
#SS(0)	If a memory address referencing the SS segment is in a non-canonical form.
#PF (fault-code)	For a page fault.
#UD	If CPUID.01H: ECX.SSE4_2 [Bit 20] = 0. If LOCK prefix is used. If REP (F3H) prefix is used.

CVTDQ2PD—Convert Packed Dword Integers to Packed Double-Precision FP Values

Opcode	Instruction	64-Bit Mode	Compat/Leg Mode	Description
F3 0F E6	CVTDQ2PD <i>xmm1</i> , <i>xmm2/m64</i>	Valid	Valid	Convert two packed signed doubleword integers from <i>xmm2/m128</i> to two packed double-precision floating-point values in <i>xmm1</i> .

Description

Converts two packed signed doubleword integers in the source operand (second operand) to two packed double-precision floating-point values in the destination operand (first operand).

The source operand can be an XMM register or a 64-bit memory location. The destination operand is an XMM register. When the source operand is an XMM register, the packed integers are located in the low quadword of the register.

In 64-bit mode, use of the REX.R prefix permits this instruction to access additional registers (XMM8-XMM15).

Operation

```
DEST[63:0] ← Convert_Integer_To_Double_Precision_Floating_Point(SRC[31:0]);
DEST[127:64] ← Convert_Integer_To_Double_Precision_Floating_Point(SRC[63:32]);
```

Intel C/C++ Compiler Intrinsic Equivalent

```
CVTDQ2PD    __m128d _mm_cvtepi32_pd(__m128i a)
```

SIMD Floating-Point Exceptions

None.

Protected Mode Exceptions

- #GP(0) For an illegal memory operand effective address in the CS, DS, ES, FS or GS segments.
- #SS(0) For an illegal address in the SS segment.
- #PF(fault-code) For a page fault.
- #NM If CR0.TS[bit 3] = 1.
- #UD If CR0.EM[bit 2] = 1.
If CR4.OSFXSR[bit 9] = 0.

	If CPUID.01H: EDX.SSE2[bit 26] = 0. If the LOCK prefix is used.
#AC(0)	If alignment checking is enabled and an unaligned memory reference is made while the current privilege level is 3.

Real-Address Mode Exceptions

GP	If any part of the operand lies outside the effective address space from 0 to FFFFH.
#NM	If CR0.TS[bit 3] = 1.
#UD	If CR0.EM[bit 2] = 1. If CR4.OSFXSR[bit 9] = 0. If CPUID.01H: EDX.SSE2[bit 26] = 0. If the LOCK prefix is used.

Virtual-8086 Mode Exceptions

Same exceptions as in real address mode.

#PF(fault-code)	For a page fault.
#AC(0)	If alignment checking is enabled and an unaligned memory reference is made.

Compatibility Mode Exceptions

Same exceptions as in protected mode.

64-Bit Mode Exceptions

#SS(0)	If a memory address referencing the SS segment is in a non-canonical form.
#GP(0)	If the memory address is in a non-canonical form.
#PF(fault-code)	For a page fault.
#NM	If CR0.TS[bit 3] = 1.
#UD	If CR0.EM[bit 2] = 1. If CR4.OSFXSR[bit 9] = 0. If CPUID.01H: EDX.SSE2[bit 26] = 0. If the LOCK prefix is used.
#AC(0)	If alignment checking is enabled and an unaligned memory reference is made while the current privilege level is 3.

CVTDQ2PS—Convert Packed Dword Integers to Packed Single-Precision FP Values

Opcode	Instruction	64-Bit Mode	Compat/Leg Mode	Description
0F 5B /r	CVTDQ2PS <i>xmm1</i> , <i>xmm2/m128</i>	Valid	Valid	Convert four packed signed doubleword integers from <i>xmm2/m128</i> to four packed single-precision floating-point values in <i>xmm1</i> .

Description

Converts four packed signed doubleword integers in the source operand (second operand) to four packed single-precision floating-point values in the destination operand (first operand).

The source operand can be an XMM register or a 128-bit memory location. The destination operand is an XMM register. When a conversion is inexact, rounding is performed according to the rounding control bits in the MXCSR register.

In 64-bit mode, use of the REX.R prefix permits this instruction to access additional registers (XMM8-XMM15).

Operation

```
DEST[31:0] ← Convert_Integer_To_Single_Precision_Floating_Point(SRC[31:0]);
DEST[63:32] ← Convert_Integer_To_Single_Precision_Floating_Point(SRC[63:32]);
DEST[95:64] ← Convert_Integer_To_Single_Precision_Floating_Point(SRC[95:64]);
DEST[127:96] ← Convert_Integer_To_Single_Precision_Floating_Point(SRC[127:96]);
```

Intel C/C++ Compiler Intrinsic Equivalent

```
CVTDQ2PS    __m128 __mm_cvtepi32_ps(__m128i a)
```

SIMD Floating-Point Exceptions

Precision.

Protected Mode Exceptions

- #GP(0) For an illegal memory operand effective address in the CS, DS, ES, FS or GS segments.
If a memory operand is not aligned on a 16-byte boundary, regardless of segment.
- #SS(0) For an illegal address in the SS segment.
- #PF(fault-code) For a page fault.

#NM	If CR0.TS[bit 3] = 1.
#XM	If an unmasked SIMD floating-point exception and CR4.OSXMMEXCPT[bit 10] = 1.
#UD	If an unmasked SIMD floating-point exception and CR4.OSXMMEXCPT[bit 10] = 0. If CR0.EM[bit 2] = 1. If CR4.OSFXSR[bit 9] = 0. If CPUID.01H:EDX.SSE2[bit 26] = 0. If the LOCK prefix is used.

Real-Address Mode Exceptions

#GP	If a memory operand is not aligned on a 16-byte boundary, regardless of segment. If any part of the operand lies outside the effective address space from 0 to FFFFH.
#NM	If CR0.TS[bit 3] = 1.
#XM	If an unmasked SIMD floating-point exception and CR4.OSXMMEXCPT[bit 10] = 1.
#UD	If an unmasked SIMD floating-point exception and CR4.OSXMMEXCPT[bit 10] = 0. If CR0.EM[bit 2] = 1. If CR4.OSFXSR[bit 9] = 0. If CPUID.01H:EDX.SSE2[bit 26] = 0. If the LOCK prefix is used.

Virtual-8086 Mode Exceptions

Same exceptions as in real address mode.

#PF(fault-code) For a page fault.

Compatibility Mode Exceptions

Same exceptions as in protected mode.

64-Bit Mode Exceptions

#SS(0)	If a memory address referencing the SS segment is in a non-canonical form.
#GP(0)	If the memory address is in a non-canonical form. If memory operand is not aligned on a 16-byte boundary, regardless of segment.
#PF(fault-code)	For a page fault.

INSTRUCTION SET REFERENCE, A-M

#NM	If CR0.TS[bit 3] = 1.
#XM	If an unmasked SIMD floating-point exception and CR4.OSXMMEXCPT[bit 10] = 1.
#UD	If an unmasked SIMD floating-point exception and CR4.OSXMMEXCPT[bit 10] = 0. If CR0.EM[bit 2] = 1. If CR4.OSFXSR[bit 9] = 0. If CPUID.01H:EDX.SSE2[bit 26] = 0. If the LOCK prefix is used.

CVTPD2DQ—Convert Packed Double-Precision FP Values to Packed Dword Integers

Opcode	Instruction	64-Bit Mode	Compat/ Leg Mode	Description
F2 0F E6	CVTPD2DQ <i>xmm1</i> , <i>xmm2/m128</i>	Valid	Valid	Convert two packed double-precision floating-point values from <i>xmm2/m128</i> to two packed signed doubleword integers in <i>xmm1</i> .

Description

Converts two packed double-precision floating-point values in the source operand (second operand) to two packed signed doubleword integers in the destination operand (first operand).

The source operand can be an XMM register or a 128-bit memory location. The destination operand is an XMM register. The result is stored in the low quadword of the destination operand and the high quadword is cleared to all 0s.

When a conversion is inexact, the value returned is rounded according to the rounding control bits in the MXCSR register. If a converted result is larger than the maximum signed doubleword integer, the floating-point invalid exception is raised, and if this exception is masked, the indefinite integer value (80000000H) is returned.

In 64-bit mode, use of the REX.R prefix permits this instruction to access additional registers (XMM8-XMM15).

Operation

```
DEST[31:0] ← Convert_Double_Precision_Floating_Point_To_Integer(SRC[63:0]);
DEST[63:32] ← Convert_Double_Precision_Floating_Point_To_Integer(SRC[127:64]);
DEST[127:64] ← 0000000000000000H;
```

Intel C/C++ Compiler Intrinsic Equivalent

```
CVTPD2DQ    __m128i _mm_cvtpd_epi32(__m128d a)
```

SIMD Floating-Point Exceptions

Invalid, Precision.

Protected Mode Exceptions

#GP(0) For an illegal memory operand effective address in the CS, DS, ES, FS or GS segments.segments.

	If a memory operand is not aligned on a 16-byte boundary, regardless of segment.
#SS(0)	For an illegal address in the SS segment.
#PF(fault-code)	For a page fault.
#NM	If CR0.TS[bit 3] = 1.
#XM	If an unmasked SIMD floating-point exception and CR4.OSXMMEXCPT[bit 10] = 1.
#UD	If an unmasked SIMD floating-point exception and CR4.OSXMMEXCPT[bit 10] = 0. If CR0.EM[bit 2] = 1. If CR4.OSFXSR[bit 9] = 0. If CPUID.01H:EDX.SSE2[bit 26] = 0. If the LOCK prefix is used.

Real-Address Mode Exceptions

#GP	If a memory operand is not aligned on a 16-byte boundary, regardless of segment. If any part of the operand lies outside the effective address space from 0 to FFFFH.
#NM	If CR0.TS[bit 3] = 1.
#XM	If an unmasked SIMD floating-point exception and CR4.OSXMMEXCPT[bit 10] = 1.
#UD	If an unmasked SIMD floating-point exception and CR4.OSXMMEXCPT[bit 10] = 0. If CR0.EM[bit 2] = 1. If CR4.OSFXSR[bit 9] = 0. If CPUID.01H:EDX.SSE2[bit 26] = 0. If the LOCK prefix is used.

Virtual-8086 Mode Exceptions

Same exceptions as in real address mode.

#PF(fault-code)	For a page fault.
-----------------	-------------------

Compatibility Mode Exceptions

Same exceptions as in protected mode.

64-Bit Mode Exceptions

#SS(0)	If a memory address referencing the SS segment is in a non-canonical form.
--------	----------------------------------------------------------------------------

#GP(0)	If the memory address is in a non-canonical form. If memory operand is not aligned on a 16-byte boundary, regardless of segment.
#PF(fault-code)	For a page fault.
#NM	If CR0.TS[bit 3] = 1.
#XM	If an unmasked SIMD floating-point exception and CR4.OSXMMEXCPT[bit 10] = 1.
#UD	If an unmasked SIMD floating-point exception and CR4.OSXMMEXCPT[bit 10] = 0. If CR0.EM[bit 2] = 1. If CR4.OSFXSR[bit 9] = 0. If CPUID.01H:EDX.SSE2[bit 26] = 0. If the LOCK prefix is used.

CVTPD2PI—Convert Packed Double-Precision FP Values to Packed Dword Integers

Opcode	Instruction	64-Bit Mode	Compat/ Leg Mode	Description
66 0F 2D /r	CVTPD2PI <i>mm</i> , <i>xmm/m128</i>	Valid	Valid	Convert two packed double-precision floating-point values from <i>xmm/m128</i> to two packed signed doubleword integers in <i>mm</i> .

Description

Converts two packed double-precision floating-point values in the source operand (second operand) to two packed signed doubleword integers in the destination operand (first operand).

The source operand can be an XMM register or a 128-bit memory location. The destination operand is an MMX technology register.

When a conversion is inexact, the value returned is rounded according to the rounding control bits in the MXCSR register. If a converted result is larger than the maximum signed doubleword integer, the floating-point invalid exception is raised, and if this exception is masked, the indefinite integer value (80000000H) is returned.

This instruction causes a transition from x87 FPU to MMX technology operation (that is, the x87 FPU top-of-stack pointer is set to 0 and the x87 FPU tag word is set to all 0s [valid]). If this instruction is executed while an x87 FPU floating-point exception is pending, the exception is handled before the CVTPD2PI instruction is executed.

In 64-bit mode, use of the REX.R prefix permits this instruction to access additional registers (XMM8-XMM15).

Operation

```
DEST[31:0] ← Convert_Double_Precision_Floating_Point_To_Integer32(SRC[63:0]);
DEST[63:32] ← Convert_Double_Precision_Floating_Point_To_Integer32(SRC[127:64]);
```

Intel C/C++ Compiler Intrinsic Equivalent

```
CVTPD1PI      __m64 __mm_cvtpd_pi32(__m128d a)
```

SIMD Floating-Point Exceptions

Invalid, Precision.

Protected Mode Exceptions

#GP(0)	For an illegal memory operand effective address in the CS, DS, ES, FS or GS segments. If a memory operand is not aligned on a 16-byte boundary, regardless of segment.
#SS(0)	For an illegal address in the SS segment.
#PF(fault-code)	For a page fault.
#MF	If there is a pending x87 FPU exception.
#NM	If CR0.TS[bit 3] = 1.
#XM	If an unmasked SIMD floating-point exception and CR4.OSXMMEXCPT[bit 10] = 1.
#UD	If an unmasked SIMD floating-point exception and CR4.OSXMMEXCPT[bit 10] = 0. If CR0.EM[bit 2] = 1. If CR4.OSFXSR[bit 9] = 0. If CPUID.01H:EDX.SSE2[bit 26] = 0. If the LOCK prefix is used.

Real-Address Mode Exceptions

#GP	If a memory operand is not aligned on a 16-byte boundary, regardless of segment. If any part of the operand lies outside the effective address space from 0 to FFFFH.
#NM	If CR0.TS[bit 3] = 1.
#MF	If there is a pending x87 FPU exception.
#XM	If an unmasked SIMD floating-point exception and CR4.OSXMMEXCPT[bit 10] = 1.
#UD	If an unmasked SIMD floating-point exception and CR4.OSXMMEXCPT[bit 10] = 0. If CR0.EM[bit 2] = 1. If CR4.OSFXSR[bit 9] = 0. If CPUID.01H:EDX.SSE2[bit 26] = 0. If the LOCK prefix is used.

Virtual-8086 Mode Exceptions

Same exceptions as in real address mode.

#PF(fault-code)	For a page fault.
-----------------	-------------------

Compatibility Mode Exceptions

Same exceptions as in protected mode.

64-Bit Mode Exceptions

#SS(0)	If a memory address referencing the SS segment is in a non-canonical form.
#GP(0)	If the memory address is in a non-canonical form. If memory operand is not aligned on a 16-byte boundary, regardless of segment.
#PF(fault-code)	For a page fault.
#MF	If there is a pending x87 FPU exception.
#NM	If CR0.TS[bit 3] = 1.
#XM	If an unmasked SIMD floating-point exception and CR4.OSXMMEXCPT[bit 10] = 1.
#UD	If an unmasked SIMD floating-point exception and CR4.OSXMMEXCPT[bit 10] = 0. If CR0.EM[bit 2] = 1. If CR4.OSFXSR[bit 9] = 0. If CPUID.01H:EDX.SSE2[bit 26] = 0. If the LOCK prefix is used.

CVTPD2PS—Convert Packed Double-Precision FP Values to Packed Single-Precision FP Values

Opcode	Instruction	64-Bit Mode	Compat/ Leg Mode	Description
66 0F 5A /r	CVTPD2PS <i>xmm1</i> , <i>xmm2/m128</i>	Valid	Valid	Convert two packed double-precision floating-point values in <i>xmm2/m128</i> to two packed single-precision floating-point values in <i>xmm1</i> .

Description

Converts two packed double-precision floating-point values in the source operand (second operand) to two packed single-precision floating-point values in the destination operand (first operand).

The source operand can be an XMM register or a 128-bit memory location. The destination operand is an XMM register. The result is stored in the low quadword of the destination operand, and the high quadword is cleared to all 0s. When a conversion is inexact, the value returned is rounded according to the rounding control bits in the MXCSR register.

In 64-bit mode, use of the REX.R prefix permits this instruction to access additional registers (XMM8-XMM15).

Operation

```
DEST[31:0] ← Convert_Double_Precision_To_Single_Precision_Floating_Point(SRC[63:0]);
DEST[63:32] ← Convert_Double_Precision_To_Single_Precision_
              Floating_Point(SRC[127:64]);
DEST[127:64] ← 0000000000000000H;
```

Intel C/C++ Compiler Intrinsic Equivalent

```
CVTPD2PS    __m128 _mm_cvtpd_ps(__m128d a)
```

SIMD Floating-Point Exceptions

Overflow, Underflow, Invalid, Precision, Denormal.

Protected Mode Exceptions

#GP(0) For an illegal memory operand effective address in the CS, DS, ES, FS or GS segments.
If a memory operand is not aligned on a 16-byte boundary, regardless of segment.

#SS(0)	For an illegal address in the SS segment.
#PF(fault-code)	For a page fault.
#NM	If CR0.TS[bit 3] = 1.
#XM	If an unmasked SIMD floating-point exception and CR4.OSXMMEXCPT[bit 10] = 1.
#UD	If an unmasked SIMD floating-point exception and CR4.OSXMMEXCPT[bit 10] = 0. If CR0.EM[bit 2] = 1. If CR4.OSFXSR[bit 9] = 0. If CPUID.01H:EDX.SSE2[bit 26] = 0. If the LOCK prefix is used.

Real-Address Mode Exceptions

#GP	If a memory operand is not aligned on a 16-byte boundary, regardless of segment. If any part of the operand lies outside the effective address space from 0 to FFFFH.
#NM	If CR0.TS[bit 3] = 1.
#XM	If an unmasked SIMD floating-point exception and CR4.OSXMMEXCPT[bit 10] = 1.
#UD	If an unmasked SIMD floating-point exception and CR4.OSXMMEXCPT[bit 10] = 0. If CR0.EM[bit 2] = 1. If CR4.OSFXSR[bit 9] = 0. If CPUID.01H:EDX.SSE2[bit 26] = 0. If the LOCK prefix is used.

Virtual-8086 Mode Exceptions

Same exceptions as in real address mode.

#PF(fault-code)	For a page fault.
-----------------	-------------------

Compatibility Mode Exceptions

Same exceptions as in protected mode.

64-Bit Mode Exceptions

#SS(0)	If a memory address referencing the SS segment is in a non-canonical form.
#GP(0)	If the memory address is in a non-canonical form. If memory operand is not aligned on a 16-byte boundary, regardless of segment.
#PF(fault-code)	For a page fault.
#NM	If CR0.TS[bit 3] = 1.
#XM	If an unmasked SIMD floating-point exception and CR4.OSXMMEXCPT[bit 10] = 1.
#UD	If an unmasked SIMD floating-point exception and CR4.OSXMMEXCPT[bit 10] = 0. If CR0.EM[bit 2] = 1. If CR4.OSFXSR[bit 9] = 0. If CPUID.01H:EDX.SSE2[bit 26] = 0. If the LOCK prefix is used.

CVTPI2PD—Convert Packed Dword Integers to Packed Double-Precision FP Values

Opcode	Instruction	64-Bit Mode	Compat/Leg Mode	Description
66 0F 2A /r	CVTPI2PD <i>xmm</i> , <i>mm/m64*</i>	Valid	Valid	Convert two packed signed doubleword integers from <i>mm/mem64</i> to two packed double-precision floating-point values in <i>xmm</i> .

NOTES:

* Operation is different for different operand sets; see the Description section.

Description

Converts two packed signed doubleword integers in the source operand (second operand) to two packed double-precision floating-point values in the destination operand (first operand).

The source operand can be an MMX technology register or a 64-bit memory location. The destination operand is an XMM register. In addition, depending on the operand configuration:

- **For operands *xmm*, *mm*:** the instruction causes a transition from x87 FPU to MMX technology operation (that is, the x87 FPU top-of-stack pointer is set to 0 and the x87 FPU tag word is set to all 0s [valid]). If this instruction is executed while an x87 FPU floating-point exception is pending, the exception is handled before the CVTPI2PD instruction is executed.
- **For operands *xmm*, *m64*:** the instruction does not cause a transition to MMX technology and does not take x87 FPU exceptions.

In 64-bit mode, use of the REX.R prefix permits this instruction to access additional registers (XMM8-XMM15).

Operation

```
DEST[63:0] ← Convert_Integer_To_Double_Precision_Floating_Point(SRC[31:0]);
DEST[127:64] ← Convert_Integer_To_Double_Precision_Floating_Point(SRC[63:32]);
```

Intel C/C++ Compiler Intrinsic Equivalent

```
CVTPI2PD __m128d _mm_cvtpi32_pd(__m64 a)
```

SIMD Floating-Point Exceptions

None.

Protected Mode Exceptions

#GP(0)	For an illegal memory operand effective address in the CS, DS, ES, FS or GS segments.
#SS(0)	For an illegal address in the SS segment.
#PF(fault-code)	For a page fault.
#NM	If CR0.TS[bit 3] = 1.
#MF	If there is a pending x87 FPU exception.
#UD	If CR0.EM[bit 2] = 1. If CR4.OSFXSR[bit 9] = 0. If CPUID.01H:EDX.SSE2[bit 26] = 0. If the LOCK prefix is used.
#AC(0)	If alignment checking is enabled and an unaligned memory reference is made while the current privilege level is 3.

Real-Address Mode Exceptions

GP	If any part of the operand lies outside the effective address space from 0 to FFFFH.
#NM	If CR0.TS[bit 3] = 1.
#MF	If there is a pending x87 FPU exception.
#UD	If CR0.EM[bit 2] = 1. If CR4.OSFXSR[bit 9] = 0. If CPUID.01H:EDX.SSE2[bit 26] = 0. If the LOCK prefix is used.

Virtual-8086 Mode Exceptions

Same exceptions as in real address mode.

#PF(fault-code)	For a page fault.
#AC(0)	If alignment checking is enabled and an unaligned memory reference is made.

Compatibility Mode Exceptions

Same exceptions as in protected mode.

64-Bit Mode Exceptions

#SS(0)	If a memory address referencing the SS segment is in a non-canonical form.
#GP(0)	If the memory address is in a non-canonical form.
#PF(fault-code)	For a page fault.
#NM	If CR0.TS[bit 3] = 1.

INSTRUCTION SET REFERENCE, A-M

#MF	If there is a pending x87 FPU exception.
#UD	If CR0.EM[bit 2] = 1. If CR4.OSFXSR[bit 9] = 0. If CPUID.01H: EDX.SSE2[bit 26] = 0. If the LOCK prefix is used.
#AC(0)	If alignment checking is enabled and an unaligned memory reference is made while the current privilege level is 3.

CVTPI2PS—Convert Packed Dword Integers to Packed Single-Precision FP Values

Opcode	Instruction	64-Bit Mode	Compat/ Leg Mode	Description
OF 2A /r	CVTPI2PS <i>xmm</i> , <i>mm/m64</i>	Valid	Valid	Convert two signed doubleword integers from <i>mm/m64</i> to two single-precision floating-point values in <i>xmm</i> .

Description

Converts two packed signed doubleword integers in the source operand (second operand) to two packed single-precision floating-point values in the destination operand (first operand).

The source operand can be an MMX technology register or a 64-bit memory location. The destination operand is an XMM register. The results are stored in the low quadword of the destination operand, and the high quadword remains unchanged. When a conversion is inexact, the value returned is rounded according to the rounding control bits in the MXCSR register.

This instruction causes a transition from x87 FPU to MMX technology operation (that is, the x87 FPU top-of-stack pointer is set to 0 and the x87 FPU tag word is set to all 0s [valid]). If this instruction is executed while an x87 FPU floating-point exception is pending, the exception is handled before the CVTPI2PS instruction is executed.

In 64-bit mode, use of the REX.R prefix permits this instruction to access additional registers (XMM8-XMM15).

Operation

```
DEST[31:0] ← Convert_Integer_To_Single_Precision_Floating_Point(SRC[31:0]);
DEST[63:32] ← Convert_Integer_To_Single_Precision_Floating_Point(SRC[63:32]);
(* High quadword of destination unchanged *)
```

Intel C/C++ Compiler Intrinsic Equivalent

```
CVTPI2PS    __m128 __mm_cvtpi32_ps(__m128 a, __m64 b)
```

SIMD Floating-Point Exceptions

Precision.

Protected Mode Exceptions

- #GP(0) For an illegal memory operand effective address in the CS, DS, ES, FS or GS segments.
- #SS(0) For an illegal address in the SS segment.

#PF(fault-code)	For a page fault.
#NM	If CR0.TS[bit 3] = 1.
#MF	If there is a pending x87 FPU exception.
#XM	If an unmasked SIMD floating-point exception and CR4.OSXMMEXCPT[bit 10] = 1.
#UD	If an unmasked SIMD floating-point exception and CR4.OSXMMEXCPT[bit 10] = 0. If CR0.EM[bit 2] = 1. If CR4.OSFXSR[bit 9] = 0. If CPUID.01H:EDX.SSE[bit 25] = 0. If the LOCK prefix is used.
#AC(0)	If alignment checking is enabled and an unaligned memory reference is made while the current privilege level is 3.

Real-Address Mode Exceptions

GP	If any part of the operand lies outside the effective address space from 0 to FFFFH.
#NM	If CR0.TS[bit 3] = 1.
#MF	If there is a pending x87 FPU exception.
#XM	If an unmasked SIMD floating-point exception and CR4.OSXMMEXCPT[bit 10] = 1.
#UD	If an unmasked SIMD floating-point exception and CR4.OSXMMEXCPT[bit 10] = 0. If CR0.EM[bit 2] = 1. If CR4.OSFXSR[bit 9] = 0. If CPUID.01H:EDX.SSE[bit 25] = 0. If the LOCK prefix is used.

Virtual-8086 Mode Exceptions

Same exceptions as in real address mode.

#PF(fault-code)	For a page fault.
#AC(0)	If alignment checking is enabled and an unaligned memory reference is made.

Compatibility Mode Exceptions

Same exceptions as in protected mode.

64-Bit Mode Exceptions

#SS(0)	If a memory address referencing the SS segment is in a non-canonical form.
#GP(0)	If the memory address is in a non-canonical form.
#PF(fault-code)	For a page fault.
#NM	If $\text{CR0.TS}[\text{bit } 3] = 1$.
#MF	If there is a pending x87 FPU exception.
#XM	If an unmasked SIMD floating-point exception and $\text{CR4.OSXMMEXCPT}[\text{bit } 10] = 1$.
#UD	If an unmasked SIMD floating-point exception and $\text{CR4.OSXMMEXCPT}[\text{bit } 10] = 0$. If $\text{CR0.EM}[\text{bit } 2] = 1$. If $\text{CR4.OSFXSR}[\text{bit } 9] = 0$. If $\text{CPUID.01H:EDX.SSE}[\text{bit } 25] = 0$. If the LOCK prefix is used.
#AC(0)	If alignment checking is enabled and an unaligned memory reference is made while the current privilege level is 3.

CVTPS2DQ—Convert Packed Single-Precision FP Values to Packed Dword Integers

Opcode	Instruction	64-Bit Mode	Compat/Leg Mode	Description
66 0F 5B /r	CVTPS2DQ <i>xmm1</i> , <i>xmm2/m128</i>	Valid	Valid	Convert four packed single-precision floating-point values from <i>xmm2/m128</i> to four packed signed doubleword integers in <i>xmm1</i> .

Description

Converts four packed single-precision floating-point values in the source operand (second operand) to four packed signed doubleword integers in the destination operand (first operand).

The source operand can be an XMM register or a 128-bit memory location. The destination operand is an XMM register.

When a conversion is inexact, the value returned is rounded according to the rounding control bits in the MXCSR register. If a converted result is larger than the maximum signed doubleword integer, the floating-point invalid exception is raised, and if this exception is masked, the indefinite integer value (80000000H) is returned.

In 64-bit mode, use of the REX.R prefix permits this instruction to access additional registers (XMM8-XMM15).

Operation

```
DEST[31:0] ← Convert_Single_Precision_Floating_Point_To_Integer(SRC[31:0]);
DEST[63:32] ← Convert_Single_Precision_Floating_Point_To_Integer(SRC[63:32]);
DEST[95:64] ← Convert_Single_Precision_Floating_Point_To_Integer(SRC[95:64]);
DEST[127:96] ← Convert_Single_Precision_Floating_Point_To_Integer(SRC[127:96]);
```

Intel C/C++ Compiler Intrinsic Equivalent

```
CVTPS2DQ __m128i __mm_cvtps_epi32(__m128 a)
```

SIMD Floating-Point Exceptions

Invalid, Precision.

Protected Mode Exceptions

#GP(0) For an illegal memory operand effective address in the CS, DS, ES, FS or GS segments.
If a memory operand is not aligned on a 16-byte boundary, regardless of segment.

#SS(0)	For an illegal address in the SS segment.
#PF(fault-code)	For a page fault.
#NM	If CR0.TS[bit 3] = 1.
#XM	If an unmasked SIMD floating-point exception and CR4.OSXMMEXCPT[bit 10] = 1.
#UD	If an unmasked SIMD floating-point exception and CR4.OSXMMEXCPT[bit 10] = 0. If CR0.EM[bit 2] = 1. If CR4.OSFXSR[bit 9] = 0. If CPUID.01H:EDX.SSE2[bit 26] = 0. If the LOCK prefix is used.

Real-Address Mode Exceptions

#GP	If a memory operand is not aligned on a 16-byte boundary, regardless of segment. If any part of the operand lies outside the effective address space from 0 to FFFFH.
#NM	If CR0.TS[bit 3] = 1.
#XM	If an unmasked SIMD floating-point exception and CR4.OSXMMEXCPT[bit 10] = 1.
#UD	If an unmasked SIMD floating-point exception and CR4.OSXMMEXCPT[bit 10] = 0. If CR0.EM[bit 2] = 1. If CR4.OSFXSR[bit 9] = 0. If CPUID.01H:EDX.SSE2[bit 26] = 0. If the LOCK prefix is used.

Virtual-8086 Mode Exceptions

Same exceptions as in real address mode.

#PF(fault-code)	For a page fault.
-----------------	-------------------

Compatibility Mode Exceptions

Same exceptions as in protected mode.

64-Bit Mode Exceptions

#SS(0)	If a memory address referencing the SS segment is in a non-canonical form.
#GP(0)	If the memory address is in a non-canonical form.

	If memory operand is not aligned on a 16-byte boundary, regardless of segment.
#PF(fault-code)	For a page fault.
#NM	If CR0.TS[bit 3] = 1.
#XM	If an unmasked SIMD floating-point exception and CR4.OSXMMEXCPT[bit 10] = 1.
#UD	If an unmasked SIMD floating-point exception and CR4.OSXMMEXCPT[bit 10] = 0. If CR0.EM[bit 2] = 1. If CR4.OSFXSR[bit 9] = 0. If CPUID.01H:EDX.SSE2[bit 26] = 0. If the LOCK prefix is used.

CVTSP2PD—Convert Packed Single-Precision FP Values to Packed Double-Precision FP Values

Opcode	Instruction	64-Bit Mode	Compat/Leg Mode	Description
OF 5A /r	CVTSP2PD <i>xmm1</i> , <i>xmm2/m64</i>	Valid	Valid	Convert two packed single-precision floating-point values in <i>xmm2/m64</i> to two packed double-precision floating-point values in <i>xmm1</i> .

Description

Converts two packed single-precision floating-point values in the source operand (second operand) to two packed double-precision floating-point values in the destination operand (first operand).

The source operand can be an XMM register or a 64-bit memory location. The destination operand is an XMM register. When the source operand is an XMM register, the packed single-precision floating-point values are contained in the low quadword of the register.

In 64-bit mode, use of the REX.R prefix permits this instruction to access additional registers (XMM8-XMM15).

Operation

```
DEST[63:0] ← Convert_Single_Precision_To_Double_Precision_Floating_Point(SRC[31:0]);
DEST[127:64] ← Convert_Single_Precision_To_Double_Precision_Floating_Point(SRC[63:32]);
```

Intel C/C++ Compiler Intrinsic Equivalent

```
CVTSP2PD    __m128d __mm_cvtps_pd(__m128 a)
```

SIMD Floating-Point Exceptions

Invalid, Denormal.

Protected Mode Exceptions

#GP(0)	For an illegal memory operand effective address in the CS, DS, ES, FS or GS segments.
#SS(0)	For an illegal address in the SS segment.
#PF(fault-code)	For a page fault.
#NM	If CR0.TS[bit 3] = 1.
#XM	If an unmasked SIMD floating-point exception and CR4.OSXMMEXCPT[bit 10] = 1.

#UD	<p>If an unmasked SIMD floating-point exception and CR4.OSXMMEXCPT[bit 10] = 0.</p> <p>If CR0.EM[bit 2] = 1.</p> <p>If CR4.OSFXSR[bit 9] = 0.</p> <p>If CPUID.01H:EDX.SSE2[bit 26] = 0.</p> <p>If the LOCK prefix is used.</p>
#AC(0)	<p>If alignment checking is enabled and an unaligned memory reference is made while the current privilege level is 3.</p>

Real-Address Mode Exceptions

GP	<p>If any part of the operand lies outside the effective address space from 0 to FFFFH.</p>
#NM	<p>If CR0.TS[bit 3] = 1.</p>
#XM	<p>If an unmasked SIMD floating-point exception and CR4.OSXMMEXCPT[bit 10] = 1.</p>
#UD	<p>If an unmasked SIMD floating-point exception and CR4.OSXMMEXCPT[bit 10] = 0.</p> <p>If CR0.EM[bit 2] = 1.</p> <p>If CR4.OSFXSR[bit 9] = 0.</p> <p>If CPUID.01H:EDX.SSE2[bit 26] = 0.</p> <p>If the LOCK prefix is used.</p>

Virtual-8086 Mode Exceptions

Same exceptions as in real address mode.

#PF(fault-code)	<p>For a page fault.</p>
#AC(0)	<p>If alignment checking is enabled and an unaligned memory reference is made.</p>

Compatibility Mode Exceptions

Same exceptions as in protected mode.

64-Bit Mode Exceptions

#SS(0)	<p>If a memory address referencing the SS segment is in a non-canonical form.</p>
#GP(0)	<p>If the memory address is in a non-canonical form.</p>
#PF(fault-code)	<p>For a page fault.</p>
#NM	<p>If CR0.TS[bit 3] = 1.</p>
#XM	<p>If an unmasked SIMD floating-point exception and CR4.OSXMMEXCPT[bit 10] = 1.</p>

#UD	<p>If an unmasked SIMD floating-point exception and CR4.OSXMMEXCPT[bit 10] = 0.</p> <p>If CR0.EM[bit 2] = 1.</p> <p>If CR4.OSFXSR[bit 9] = 0.</p> <p>If CPUID.01H:EDX.SSE2[bit 26] = 0.</p> <p>If the LOCK prefix is used.</p>
#AC(0)	<p>If alignment checking is enabled and an unaligned memory reference is made while the current privilege level is 3.</p>

CVTPS2PI—Convert Packed Single-Precision FP Values to Packed Dword Integers

Opcode	Instruction	64-Bit Mode	Compat/Leg Mode	Description
OF 2D /r	CVTPS2PI <i>mm</i> , <i>xmm/m64</i>	Valid	Valid	Convert two packed single-precision floating-point values from <i>xmm/m64</i> to two packed signed doubleword integers in <i>mm</i> .

Description

Converts two packed single-precision floating-point values in the source operand (second operand) to two packed signed doubleword integers in the destination operand (first operand).

The source operand can be an XMM register or a 128-bit memory location. The destination operand is an MMX technology register. When the source operand is an XMM register, the two single-precision floating-point values are contained in the low quadword of the register. When a conversion is inexact, the value returned is rounded according to the rounding control bits in the MXCSR register. If a converted result is larger than the maximum signed doubleword integer, the floating-point invalid exception is raised, and if this exception is masked, the indefinite integer value (80000000H) is returned.

CVTPS2PI causes a transition from x87 FPU to MMX technology operation (that is, the x87 FPU top-of-stack pointer is set to 0 and the x87 FPU tag word is set to all 0s [valid]). If this instruction is executed while an x87 FPU floating-point exception is pending, the exception is handled before the CVTPS2PI instruction is executed.

In 64-bit mode, use of the REX.R prefix permits this instruction to access additional registers (XMM8-XMM15).

Operation

```
DEST[31:0] ← Convert_Single_Precision_Floating_Point_To_Integer(SRC[31:0]);
DEST[63:32] ← Convert_Single_Precision_Floating_Point_To_Integer(SRC[63:32]);
```

Intel C/C++ Compiler Intrinsic Equivalent

```
CVTPS2PI __m64 __mm_cvtps_pi32(__m128 a)
```

SIMD Floating-Point Exceptions

Invalid, Precision.

Protected Mode Exceptions

#GP(0)	For an illegal memory operand effective address in the CS, DS, ES, FS or GS segments.
#SS(0)	For an illegal address in the SS segment.
#PF(fault-code)	For a page fault.
#MF	If there is a pending x87 FPU exception.
#NM	If CR0.TS[bit 3] = 1.
#XM	If an unmasked SIMD floating-point exception and CR4.OSXMMEXCPT[bit 10] = 1.
#UD	If an unmasked SIMD floating-point exception and CR4.OSXMMEXCPT[bit 10] = 0. If CR0.EM[bit 2] = 1. If CR4.OSFXSR[bit 9] = 0. If CPUID.01H: EDX.SSE[bit 25] = 0. If the LOCK prefix is used.
#AC(0)	If alignment checking is enabled and an unaligned memory reference is made while the current privilege level is 3.

Real-Address Mode Exceptions

GP	If any part of the operand lies outside the effective address space from 0 to FFFFH.
#NM	If CR0.TS[bit 3] = 1.
#MF	If there is a pending x87 FPU exception.
#XM	If an unmasked SIMD floating-point exception and CR4.OSXMMEXCPT[bit 10] = 1.
#UD	If an unmasked SIMD floating-point exception and CR4.OSXMMEXCPT[bit 10] = 0. If CR0.EM[bit 2] = 1. If CR4.OSFXSR[bit 9] = 0. If CPUID.01H: EDX.SSE[bit 25] = 0. If the LOCK prefix is used.

Virtual-8086 Mode Exceptions

Same exceptions as in real address mode.

#PF(fault-code)	For a page fault.
#AC(0)	If alignment checking is enabled and an unaligned memory reference is made.

Compatibility Mode Exceptions

Same exceptions as in protected mode.

64-Bit Mode Exceptions

#SS(0)	If a memory address referencing the SS segment is in a non-canonical form.
#GP(0)	If the memory address is in a non-canonical form.
#PF(fault-code)	For a page fault.
#NM	If $\text{CR0.TS}[\text{bit } 3] = 1$.
#MF	If there is a pending x87 FPU exception.
#XM	If an unmasked SIMD floating-point exception and $\text{CR4.OSXMMEXCPT}[\text{bit } 10] = 1$.
#UD	If an unmasked SIMD floating-point exception and $\text{CR4.OSXMMEXCPT}[\text{bit } 10] = 0$. If $\text{CR0.EM}[\text{bit } 2] = 1$. If $\text{CR4.OSFXSR}[\text{bit } 9] = 0$. If $\text{CPUID.01H:EDX.SSE}[\text{bit } 25] = 0$. If the LOCK prefix is used.
#AC(0)	If alignment checking is enabled and an unaligned memory reference is made while the current privilege level is 3.

CVTSD2SI—Convert Scalar Double-Precision FP Value to Integer

Opcode	Instruction	64-Bit Mode	Compat/ Leg Mode	Description
F2 0F 2D /r	CVTSD2SI <i>r32</i> , <i>xmm/m64</i>	Valid	Valid	Convert one double-precision floating-point value from <i>xmm/m64</i> to one signed doubleword integer <i>r32</i> .
F2 REX.W 0F 2D /r	CVTSD2SI <i>r64</i> , <i>xmm/m64</i>	Valid	N.E.	Convert one double-precision floating-point value from <i>xmm/m64</i> to one signed quadword integer sign-extended into <i>r64</i> .

Description

Converts a double-precision floating-point value in the source operand (second operand) to a signed doubleword integer in the destination operand (first operand). The source operand can be an XMM register or a 64-bit memory location. The destination operand is a general-purpose register. When the source operand is an XMM register, the double-precision floating-point value is contained in the low quadword of the register.

When a conversion is inexact, the value returned is rounded according to the rounding control bits in the MXCSR register. If a converted result is larger than the maximum signed doubleword integer, the floating-point invalid exception is raised, and if this exception is masked, the indefinite integer value (80000000H) is returned.

In 64-bit mode, the instruction can access additional registers (XMM8-XMM15, R8-R15) when used with a REX.R prefix. Use of the REX.W prefix promotes the instruction to 64-bit operation. See the summary chart at the beginning of this section for encoding data and limits.

Operation

```
IF 64-Bit Mode and OperandSize = 64
  THEN
    DEST[63:0] ← Convert_Double_Precision_Floating_Point_To_Integer64(SRC[63:0]);
  ELSE
    DEST[31:0] ← Convert_Double_Precision_Floating_Point_To_Integer32(SRC[63:0]);
FI;
```

Intel C/C++ Compiler Intrinsic Equivalent

```
int _mm_cvtsd_si32(__m128d a)
```

SIMD Floating-Point Exceptions

Invalid, Precision.

Protected Mode Exceptions

#GP(0)	For an illegal memory operand effective address in the CS, DS, ES, FS or GS segments.
#SS(0)	For an illegal address in the SS segment.
#PF(fault-code)	For a page fault.
#NM	If CR0.TS[bit 3] = 1.
#XM	If an unmasked SIMD floating-point exception and CR4.OSXMMEXCPT[bit 10] = 1.
#UD	If an unmasked SIMD floating-point exception and CR4.OSXMMEXCPT[bit 10] = 0. If CR0.EM[bit 2] = 1. If CR4.OSFXSR[bit 9] = 0. If CPUID.01H:EDX.SSE2[bit 26] = 0. If the LOCK prefix is used.
#AC(0)	If alignment checking is enabled and an unaligned memory reference is made while the current privilege level is 3.

Real-Address Mode Exceptions

GP	If any part of the operand lies outside the effective address space from 0 to FFFFH.
#NM	If CR0.TS[bit 3] = 1.
#XM	If an unmasked SIMD floating-point exception and CR4.OSXMMEXCPT[bit 10] = 1.
#UD	If an unmasked SIMD floating-point exception and CR4.OSXMMEXCPT[bit 10] = 0. If CR0.EM[bit 2] = 1. If CR4.OSFXSR[bit 9] = 0. If CPUID.01H:EDX.SSE2[bit 26] = 0. If the LOCK prefix is used.

Virtual-8086 Mode Exceptions

Same exceptions as in real address mode.

#PF(fault-code)	For a page fault.
#AC(0)	If alignment checking is enabled and an unaligned memory reference is made.

Compatibility Mode Exceptions

Same exceptions as in protected mode.

64-Bit Mode Exceptions

#SS(0)	If a memory address referencing the SS segment is in a non-canonical form.
#GP(0)	If the memory address is in a non-canonical form.
#PF(fault-code)	For a page fault.
#NM	If $\text{CR0.TS}[\text{bit } 3] = 1$.
#XM	If an unmasked SIMD floating-point exception and $\text{CR4.OSXMMEXCPT}[\text{bit } 10] = 1$.
#UD	If an unmasked SIMD floating-point exception and $\text{CR4.OSXMMEXCPT}[\text{bit } 10] = 0$. If $\text{CR0.EM}[\text{bit } 2] = 1$. If $\text{CR4.OSFXSR}[\text{bit } 9] = 0$. If $\text{CPUID.01H:EDX.SSE2}[\text{bit } 26] = 0$. If the LOCK prefix is used.
#AC(0)	If alignment checking is enabled and an unaligned memory reference is made while the current privilege level is 3.

CVTSD2SS—Convert Scalar Double-Precision FP Value to Scalar Single-Precision FP Value

Opcode	Instruction	64-Bit Mode	Compat/ Leg Mode	Description
F2 0F 5A /r	CVTSD2SS <i>xmm1</i> , <i>xmm2/m64</i>	Valid	Valid	Convert one double-precision floating-point value in <i>xmm2/m64</i> to one single-precision floating-point value in <i>xmm1</i> .

Description

Converts a double-precision floating-point value in the source operand (second operand) to a single-precision floating-point value in the destination operand (first operand).

The source operand can be an XMM register or a 64-bit memory location. The destination operand is an XMM register. When the source operand is an XMM register, the double-precision floating-point value is contained in the low quadword of the register. The result is stored in the low doubleword of the destination operand, and the upper 3 doublewords are left unchanged. When the conversion is inexact, the value returned is rounded according to the rounding control bits in the MXCSR register.

In 64-bit mode, use of the REX.R prefix permits this instruction to access additional registers (XMM8-XMM15).

Operation

DEST[31:0] ← Convert_Double_Precision_To_Single_Precision_Floating_Point(SRC[63:0]);
(* DEST[127:32] unchanged *)

Intel C/C++ Compiler Intrinsic Equivalent

CVTSD2SS `__m128_mm_cvtssd_ss(__m128 a, __m128d b)`

SIMD Floating-Point Exceptions

Overflow, Underflow, Invalid, Precision, Denormal.

Protected Mode Exceptions

- #GP(0) For an illegal memory operand effective address in the CS, DS, ES, FS or GS segments.
- #SS(0) For an illegal address in the SS segment.
- #PF(fault-code) For a page fault.
- #NM If CRO.TS[bit 3] = 1.

#XM	If an unmasked SIMD floating-point exception and CR4.OSXMMEXCPT[bit 10] = 1.
#UD	If an unmasked SIMD floating-point exception and CR4.OSXMMEXCPT[bit 10] = 0. If CR0.EM[bit 2] = 1. If CR4.OSFXSR[bit 9] = 0. If CPUID.01H:EDX.SSE2[bit 26] = 0. If the LOCK prefix is used.
#AC(0)	If alignment checking is enabled and an unaligned memory reference is made while the current privilege level is 3.

Real-Address Mode Exceptions

GP	If any part of the operand lies outside the effective address space from 0 to FFFFH.
#NM	If CR0.TS[bit 3] = 1.
#XM	If an unmasked SIMD floating-point exception and CR4.OSXMMEXCPT[bit 10] = 1.
#UD	If an unmasked SIMD floating-point exception and CR4.OSXMMEXCPT[bit 10] = 0. If CR0.EM[bit 2] = 1. If CR4.OSFXSR[bit 9] = 0. If CPUID.01H:EDX.SSE2[bit 26] = 0. If the LOCK prefix is used.

Virtual-8086 Mode Exceptions

Same exceptions as in real address mode.

#PF(fault-code)	For a page fault.
#AC(0)	If alignment checking is enabled and an unaligned memory reference is made.

Compatibility Mode Exceptions

Same exceptions as in protected mode.

64-Bit Mode Exceptions

#SS(0)	If a memory address referencing the SS segment is in a non-canonical form.
#GP(0)	If the memory address is in a non-canonical form.
#PF(fault-code)	For a page fault.
#NM	If CR0.TS[bit 3] = 1.

INSTRUCTION SET REFERENCE, A-M

#XM	If an unmasked SIMD floating-point exception and CR4.OSXMMEXCPT[bit 10] = 1.
#UD	If an unmasked SIMD floating-point exception and CR4.OSXMMEXCPT[bit 10] = 0. If CR0.EM[bit 2] = 1. If CR4.OSFXSR[bit 9] = 0. If CPUID.01H:EDX.SSE2[bit 26] = 0. If the LOCK prefix is used.
#AC(0)	If alignment checking is enabled and an unaligned memory reference is made while the current privilege level is 3.

CVTSI2SD—Convert Dword Integer to Scalar Double-Precision FP Value

Opcode	Instruction	64-Bit Mode	Compat/ Leg Mode	Description
F2 0F 2A /r	CVTSI2SD <i>xmm</i> , <i>r/m32</i>	Valid	Valid	Convert one signed doubleword integer from <i>r/m32</i> to one double-precision floating-point value in <i>xmm</i> .
F2 REX.W 0F 2A /r	CVTSI2SD <i>xmm</i> , <i>r/m64</i>	Valid	N.E.	Convert one signed quadword integer from <i>r/m64</i> to one double-precision floating-point value in <i>xmm</i> .

Description

Converts a signed doubleword integer (or signed quadword integer if operand size is 64 bits) in the source operand (second operand) to a double-precision floating-point value in the destination operand (first operand). The source operand can be a general-purpose register or a memory location. The destination operand is an XMM register. The result is stored in the low quadword of the destination operand, and the high quadword left unchanged.

In 64-bit mode, the instruction can access additional registers (XMM8-XMM15, R8-R15) when used with a REX.R prefix. Use of the REX.W prefix promotes the instruction to 64-bit operands. See the summary chart at the beginning of this section for encoding data and limits.

Operation

```
IF 64-Bit Mode And OperandSize = 64
  THEN
    DEST[63:0] ← Convert_Integer_To_Double_Precision_Floating_Point(SRC[63:0]);
    (* DEST[127:64] unchanged *)
  ELSE
    DEST[63:0] ← Convert_Integer_To_Double_Precision_Floating_Point(SRC[31:0]);
    (* DEST[127:64] unchanged *)
FI;
```

Intel C/C++ Compiler Intrinsic Equivalent

```
CVTSI2SD    __m128d _mm_cvtsi32_sd(__m128d a, int b)
```

SIMD Floating-Point Exceptions

None.

Protected Mode Exceptions

#GP(0)	For an illegal memory operand effective address in the CS, DS, ES, FS or GS segments.
#SS(0)	For an illegal address in the SS segment.
#PF(fault-code)	For a page fault.
#NM	If CR0.TS[bit 3] = 1.
#XM	If an unmasked SIMD floating-point exception and CR4.OSXMMEXCPT[bit 10] = 1.
#UD	If an unmasked SIMD floating-point exception and CR4.OSXMMEXCPT[bit 10] = 0. If CR0.EM[bit 2] = 1. If CR4.OSFXSR[bit 9] = 0. If CPUID.01H:EDX.SSE2[bit 26] = 0. If the LOCK prefix is used.
#AC(0)	If alignment checking is enabled and an unaligned memory reference is made while the current privilege level is 3.

Real-Address Mode Exceptions

GP	If any part of the operand lies outside the effective address space from 0 to FFFFH.
#NM	If CR0.TS[bit 3] = 1.
#XM	If an unmasked SIMD floating-point exception and CR4.OSXMMEXCPT[bit 10] = 1.
#UD	If an unmasked SIMD floating-point exception and CR4.OSXMMEXCPT[bit 10] = 0. If CR0.EM[bit 2] = 1. If CR4.OSFXSR[bit 9] = 0. If CPUID.01H:EDX.SSE2[bit 26] = 0. If the LOCK prefix is used.

Virtual-8086 Mode Exceptions

Same exceptions as in real address mode.

#PF(fault-code)	For a page fault.
#AC(0)	If alignment checking is enabled and an unaligned memory reference is made.

Compatibility Mode Exceptions

Same exceptions as in protected mode.

64-Bit Mode Exceptions

#SS(0)	If a memory address referencing the SS segment is in a non-canonical form.
#GP(0)	If the memory address is in a non-canonical form.
#PF(fault-code)	For a page fault.
#NM	If $CR0.TS[\text{bit } 3] = 1$.
#XM	If an unmasked SIMD floating-point exception and $CR4.OSXMMEXCPT[\text{bit } 10] = 1$.
#UD	If an unmasked SIMD floating-point exception and $CR4.OSXMMEXCPT[\text{bit } 10] = 0$. If $CR0.EM[\text{bit } 2] = 1$. If $CR4.OSFXSR[\text{bit } 9] = 0$. If $CPUID.01H:EDX.SSE2[\text{bit } 26] = 0$. If the LOCK prefix is used.
#AC(0)	If alignment checking is enabled and an unaligned memory reference is made while the current privilege level is 3.

CVTSI2SS—Convert Dword Integer to Scalar Single-Precision FP Value

Opcode	Instruction	64-Bit Mode	Compat/ Leg Mode	Description
F3 0F 2A /r	CVTSI2SS <i>xmm, r/m32</i>	Valid	Valid	Convert one signed doubleword integer from <i>r/m32</i> to one single-precision floating-point value in <i>xmm</i> .
F3 REX.W 0F 2A /r	CVTSI2SS <i>xmm, r/m64</i>	Valid	N.E.	Convert one signed quadword integer from <i>r/m64</i> to one single-precision floating-point value in <i>xmm</i> .

Description

Converts a signed doubleword integer (or signed quadword integer if operand size is 64 bits) in the source operand (second operand) to a single-precision floating-point value in the destination operand (first operand). The source operand can be a general-purpose register or a memory location. The destination operand is an XMM register. The result is stored in the low doubleword of the destination operand, and the upper three doublewords are left unchanged. When a conversion is inexact, the value returned is rounded according to the rounding control bits in the MXCSR register.

In 64-bit mode, the instruction can access additional registers (XMM8-XMM15, R8-R15) when used with a REX.R prefix. Use of the REX.W prefix promotes the instruction to 64-bit operands. See the summary chart at the beginning of this section for encoding data and limits.

Operation

```
IF 64-Bit Mode And OperandSize = 64
  THEN
    DEST[31:0] ← Convert_Integer_To_Single_Precision_Floating_Point(SRC[63:0]);
    (* DEST[127:32] unchanged *)
  ELSE
    DEST[31:0] ← Convert_Integer_To_Single_Precision_Floating_Point(SRC[31:0]);
    (* DEST[127:32] unchanged *)
FI;
```

Intel C/C++ Compiler Intrinsic Equivalent

```
CVTSI2SS    __m128 _mm_cvtsi32_ss(__m128 a, int b)
```

SIMD Floating-Point Exceptions

Precision.

Protected Mode Exceptions

#GP(0)	For an illegal memory operand effective address in the CS, DS, ES, FS or GS segments.
#SS(0)	For an illegal address in the SS segment.
#PF(fault-code)	For a page fault.
#NM	If CR0.TS[bit 3] = 1.
#XM	If an unmasked SIMD floating-point exception and CR4.OSXMMEXCPT[bit 10] = 1.
#UD	If an unmasked SIMD floating-point exception and CR4.OSXMMEXCPT[bit 10] = 0. If CR0.EM[bit 2] = 1. If CR4.OSFXSR[bit 9] = 0. If CPUID.01H:EDX.SSE[bit 25] = 0. If the LOCK prefix is used.
#AC(0)	If alignment checking is enabled and an unaligned memory reference is made while the current privilege level is 3.

Real-Address Mode Exceptions

GP	If any part of the operand lies outside the effective address space from 0 to FFFFH.
#NM	If CR0.TS[bit 3] = 1.
#XM	If an unmasked SIMD floating-point exception and CR4.OSXMMEXCPT[bit 10] = 1.
#UD	If an unmasked SIMD floating-point exception and CR4.OSXMMEXCPT[bit 10] = 0. If CR0.EM[bit 2] = 1. If CR4.OSFXSR[bit 9] = 0. If CPUID.01H:EDX.SSE[bit 25] = 0. If the LOCK prefix is used.

Virtual-8086 Mode Exceptions

Same exceptions as in real address mode.

#PF(fault-code)	For a page fault.
#AC(0)	If alignment checking is enabled and an unaligned memory reference is made.

Compatibility Mode Exceptions

Same exceptions as in protected mode.

64-Bit Mode Exceptions

#SS(0)	If a memory address referencing the SS segment is in a non-canonical form.
#GP(0)	If the memory address is in a non-canonical form.
#PF(fault-code)	For a page fault.
#NM	If $\text{CR0.TS}[\text{bit } 3] = 1$.
#XM	If an unmasked SIMD floating-point exception and $\text{CR4.OSXMMEXCPT}[\text{bit } 10] = 1$.
#UD	If an unmasked SIMD floating-point exception and $\text{CR4.OSXMMEXCPT}[\text{bit } 10] = 0$. If $\text{CR0.EM}[\text{bit } 2] = 1$. If $\text{CR4.OSFXSR}[\text{bit } 9] = 0$. If $\text{CPUID.01H:EDX.SSE}[\text{bit } 25] = 0$. If the LOCK prefix is used.
#AC(0)	If alignment checking is enabled and an unaligned memory reference is made while the current privilege level is 3.

CVTSS2SD—Convert Scalar Single-Precision FP Value to Scalar Double-Precision FP Value

Opcode	Instruction	64-Bit Mode	Compat/Leg Mode	Description
F3 0F 5A /r	CVTSS2SD <i>xmm1</i> , <i>xmm2/m32</i>	Valid	Valid	Convert one single-precision floating-point value in <i>xmm2/m32</i> to one double-precision floating-point value in <i>xmm1</i> .

Description

Converts a single-precision floating-point value in the source operand (second operand) to a double-precision floating-point value in the destination operand (first operand). The source operand can be an XMM register or a 32-bit memory location. The destination operand is an XMM register. When the source operand is an XMM register, the single-precision floating-point value is contained in the low doubleword of the register. The result is stored in the low quadword of the destination operand, and the high quadword is left unchanged.

In 64-bit mode, use of the REX.R prefix permits this instruction to access additional registers (XMM8-XMM15).

Operation

DEST[63:0] ← Convert_Single_Precision_To_Double_Precision_Floating_Point(SRC[31:0]);
(* DEST[127:64] unchanged *)

Intel C/C++ Compiler Intrinsic Equivalent

CVTSS2SD __m128d __mm_cvtss_sd(__m128d a, __m128 b)

SIMD Floating-Point Exceptions

Invalid, Denormal.

Protected Mode Exceptions

#GP(0)	For an illegal memory operand effective address in the CS, DS, ES, FS or GS segments.
#SS(0)	For an illegal address in the SS segment.
#PF(fault-code)	For a page fault.
#NM	If CR0.TS[bit 3] = 1.
#XM	If an unmasked SIMD floating-point exception and CR4.OSXMMEXCPT[bit 10] = 1.

#UD	If an unmasked SIMD floating-point exception and CR4.OSXMMEXCPT[bit 10] = 0. If CR0.EM[bit 2] = 1. If CR4.OSFXSR[bit 9] = 0. If CPUID.01H:EDX.SSE2[bit 26] = 0. If the LOCK prefix is used.
#AC(0)	If alignment checking is enabled and an unaligned memory reference is made while the current privilege level is 3.

Real-Address Mode Exceptions

GP	If any part of the operand lies outside the effective address space from 0 to FFFFH.
#NM	If CR0.TS[bit 3] = 1.
#XM	If an unmasked SIMD floating-point exception and CR4.OSXMMEXCPT[bit 10] = 1.
#UD	If an unmasked SIMD floating-point exception and CR4.OSXMMEXCPT[bit 10] = 0. If CR0.EM[bit 2] = 1. If CR4.OSFXSR[bit 9] = 0. If CPUID.01H:EDX.SSE2[bit 26] = 0. If the LOCK prefix is used.

Virtual-8086 Mode Exceptions

Same exceptions as in real address mode.

#PF(fault-code)	For a page fault.
#AC(0)	If alignment checking is enabled and an unaligned memory reference is made.

Compatibility Mode Exceptions

Same exceptions as in protected mode.

64-Bit Mode Exceptions

#SS(0)	If a memory address referencing the SS segment is in a non-canonical form.
#GP(0)	If the memory address is in a non-canonical form.
#PF(fault-code)	For a page fault.
#NM	If CR0.TS[bit 3] = 1.
#XM	If an unmasked SIMD floating-point exception and CR4.OSXMMEXCPT[bit 10] = 1.

#UD	<p>If an unmasked SIMD floating-point exception and CR4.OSXMMEXCPT[bit 10] = 0 exception and CR4.OSXMMEXCPT[bit 10] = 0.</p> <p>If CR0.EM[bit 2] = 1.</p> <p>If CR4.OSFXSR[bit 9] = 0.</p> <p>If CPUID.01H:EDX.SSE2[bit 26] = 0.</p> <p>If the LOCK prefix is used.</p>
#AC(0)	<p>If alignment checking is enabled and an unaligned memory reference is made while the current privilege level is 3.</p>

CVTSS2SI—Convert Scalar Single-Precision FP Value to Dword Integer

Opcode	Instruction	64-Bit Mode	Compat/ Leg Mode	Description
F3 0F 2D /r	CVTSS2SI <i>r32</i> , <i>xmm/m32</i>	Valid	Valid	Convert one single-precision floating-point value from <i>xmm/m32</i> to one signed doubleword integer in <i>r32</i> .
F3 REX.W 0F 2D /r	CVTSS2SI <i>r64</i> , <i>xmm/m32</i>	Valid	N.E.	Convert one single-precision floating-point value from <i>xmm/m32</i> to one signed quadword integer in <i>r64</i> .

Description

Converts a single-precision floating-point value in the source operand (second operand) to a signed doubleword integer (or signed quadword integer if operand size is 64 bits) in the destination operand (first operand). The source operand can be an XMM register or a memory location. The destination operand is a general-purpose register. When the source operand is an XMM register, the single-precision floating-point value is contained in the low doubleword of the register.

When a conversion is inexact, the value returned is rounded according to the rounding control bits in the MXCSR register. If a converted result is larger than the maximum signed doubleword integer, the floating-point invalid exception is raised, and if this exception is masked, the indefinite integer value (80000000H) is returned.

In 64-bit mode, the instruction can access additional registers (XMM8-XMM15, R8-R15) when used with a REX.R prefix. Use of the REX.W prefix promotes the instruction to 64-bit operands. See the summary chart at the beginning of this section for encoding data and limits.

Operation

```
IF 64-bit Mode and OperandSize = 64
  THEN
    DEST[64:0] ← Convert_Single_Precision_Floating_Point_To_Integer(SRC[31:0]);
  ELSE
    DEST[31:0] ← Convert_Single_Precision_Floating_Point_To_Integer(SRC[31:0]);
FI;
```

Intel C/C++ Compiler Intrinsic Equivalent

```
int _mm_cvtss_si32(__m128d a)
```

SIMD Floating-Point Exceptions

Invalid, Precision.

Protected Mode Exceptions

#GP(0)	For an illegal memory operand effective address in the CS, DS, ES, FS or GS segments.
#SS(0)	For an illegal address in the SS segment.
#PF(fault-code)	For a page fault.
#NM	If CR0.TS[bit 3] = 1.
#XM	If an unmasked SIMD floating-point exception and CR4.OSXMMEXCPT[bit 10] = 1.
#UD	If an unmasked SIMD floating-point exception and CR4.OSXMMEXCPT[bit 10] = 0. If CR0.EM[bit 2] = 1. If CR4.OSFXSR[bit 9] = 0. If CPUID.01H: EDX.SSE[bit 25] = 0. If the LOCK prefix is used.
#AC(0)	If alignment checking is enabled and an unaligned memory reference is made while the current privilege level is 3.

Real-Address Mode Exceptions

GP	If any part of the operand lies outside the effective address space from 0 to FFFFH.
#NM	If CR0.TS[bit 3] = 1.
#XM	If an unmasked SIMD floating-point exception and CR4.OSXMMEXCPT[bit 10] = 1.
#UD	If an unmasked SIMD floating-point exception and CR4.OSXMMEXCPT[bit 10] = 0. If CR0.EM[bit 2] = 1. If CR4.OSFXSR[bit 9] = 0. If CPUID.01H: EDX.SSE[bit 25] = 0. If the LOCK prefix is used.

Virtual-8086 Mode Exceptions

Same exceptions as in real address mode.

#PF(fault-code)	For a page fault.
#AC(0)	If alignment checking is enabled and an unaligned memory reference is made.

Compatibility Mode Exceptions

Same exceptions as in protected mode.

64-Bit Mode Exceptions

#SS(0)	If a memory address referencing the SS segment is in a non-canonical form.
#GP(0)	If the memory address is in a non-canonical form.
#PF(fault-code)	For a page fault.
#NM	If $\text{CR0.TS}[\text{bit } 3] = 1$.
#XM	If an unmasked SIMD floating-point exception and $\text{CR4.OSXMMEXCPT}[\text{bit } 10] = 1$.
#UD	If an unmasked SIMD floating-point exception and $\text{CR4.OSXMMEXCPT}[\text{bit } 10] = 0$. If $\text{CR0.EM}[\text{bit } 2] = 1$. If $\text{CR4.OSFXSR}[\text{bit } 9] = 0$. If $\text{CPUID.01H:EDX.SSE}[\text{bit } 25] = 0$. If the LOCK prefix is used.
#AC(0)	If alignment checking is enabled and an unaligned memory reference is made while the current privilege level is 3.

CVTTPD2DQ—Convert with Truncation Packed Double-Precision FP Values to Packed Dword Integers

Opcode	Instruction	64-Bit Mode	Compat/Leg Mode	Description
66 0F E6	CVTTPD2DQ <i>xmm1</i> , <i>xmm2/m128</i>	Valid	Valid	Convert two packed double-precision floating-point values from <i>xmm2/m128</i> to two packed signed doubleword integers in <i>xmm1</i> using truncation.

Description

Converts two packed double-precision floating-point values in the source operand (second operand) to two packed signed doubleword integers in the destination operand (first operand). The source operand can be an XMM register or a 128-bit memory location. The destination operand is an XMM register. The result is stored in the low quadword of the destination operand and the high quadword is cleared to all 0s.

When a conversion is inexact, a truncated (round toward zero) result is returned. If a converted result is larger than the maximum signed doubleword integer, the floating-point invalid exception is raised, and if this exception is masked, the indefinite integer value (80000000H) is returned.

In 64-bit mode, use of the REX.R prefix permits this instruction to access additional registers (XMM8-XMM15).

Operation

```
DEST[31:0] ← Convert_Double_Precision_Floating_Point_To_Integer_Truncate(SRC[63:0]);
DEST[63:32] ← Convert_Double_Precision_Floating_Point_To_Integer_
               Truncate(SRC[127-64]);
DEST[127:64] ← 0000000000000000H;
```

Intel C/C++ Compiler Intrinsic Equivalent

```
CVTTPD2DQ    __m128i _mm_cvttpd_epi32(__m128d a)
```

SIMD Floating-Point Exceptions

Invalid, Precision.

Protected Mode Exceptions

#GP(0) For an illegal memory operand effective address in the CS, DS, ES, FS or GS segments.

	If a memory operand is not aligned on a 16-byte boundary, regardless of segment.
#SS(0)	For an illegal address in the SS segment.
#PF(fault-code)	For a page fault.
#NM	If CR0.TS[bit 3] = 1.
#XM	If an unmasked SIMD floating-point exception and CR4.OSXMMEXCPT[bit 10] = 1.
#UD	If an unmasked SIMD floating-point exception and CR4.OSXMMEXCPT[bit 10] = 0. If CR0.EM[bit 2] = 1. If CR4.OSFXSR[bit 9] = 0. If CPUID.01H:EDX.SSE2[bit 26] = 0. If the LOCK prefix is used.

Real-Address Mode Exceptions

#GP	If a memory operand is not aligned on a 16-byte boundary, regardless of segment. If any part of the operand lies outside the effective address space from 0 to FFFFH.
#NM	If CR0.TS[bit 3] = 1.
#XM	If an unmasked SIMD floating-point exception and CR4.OSXMMEXCPT[bit 10] = 1.
#UD	If an unmasked SIMD floating-point exception and CR4.OSXMMEXCPT[bit 10] = 0. If CR0.EM[bit 2] = 1. If CR4.OSFXSR[bit 9] = 0. If CPUID.01H:EDX.SSE2[bit 26] = 0. If the LOCK prefix is used.

Virtual-8086 Mode Exceptions

Same exceptions as in real address mode.

#PF(fault-code)	For a page fault.
-----------------	-------------------

Compatibility Mode Exceptions

Same exceptions as in protected mode.

64-Bit Mode Exceptions

#SS(0)	If a memory address referencing the SS segment is in a non-canonical form.
--------	----------------------------------------------------------------------------

#GP(0)	If the memory address is in a non-canonical form. If memory operand is not aligned on a 16-byte boundary, regardless of segment.
#PF(fault-code)	For a page fault.
#NM	If CR0.TS[bit 3] = 1.
#XM	If an unmasked SIMD floating-point exception and CR4.OSXMMEXCPT[bit 10] = 1.
#UD	If an unmasked SIMD floating-point exception and CR4.OSXMMEXCPT[bit 10] = 0. If CR0.EM[bit 2] = 1. If CR4.OSFXSR[bit 9] = 0. If CPUID.01H:EDX.SSE2[bit 26] = 0. If the LOCK prefix is used.

CVTTPD2PI—Convert with Truncation Packed Double-Precision FP Values to Packed Dword Integers

Opcode	Instruction	64-Bit Mode	Compat/Leg Mode	Description
66 0F 2C /r	CVTTPD2PI <i>mm</i> , <i>xmm/m128</i>	Valid	Valid	Convert two packed double-precision floating-point values from <i>xmm/m128</i> to two packed signed doubleword integers in <i>mm</i> using truncation.

Description

Converts two packed double-precision floating-point values in the source operand (second operand) to two packed signed doubleword integers in the destination operand (first operand). The source operand can be an XMM register or a 128-bit memory location. The destination operand is an MMX technology register.

When a conversion is inexact, a truncated (round toward zero) result is returned. If a converted result is larger than the maximum signed doubleword integer, the floating-point invalid exception is raised, and if this exception is masked, the indefinite integer value (80000000H) is returned.

This instruction causes a transition from x87 FPU to MMX technology operation (that is, the x87 FPU top-of-stack pointer is set to 0 and the x87 FPU tag word is set to all 0s [valid]). If this instruction is executed while an x87 FPU floating-point exception is pending, the exception is handled before the CVTTPD2PI instruction is executed.

In 64-bit mode, use of the REX.R prefix permits this instruction to access additional registers (XMM8-XMM15).

Operation

```
DEST[31:0] ← Convert_Double_Precision_Floating_Point_To_Integer32_Truncate(SRC[63:0]);
DEST[63:32] ← Convert_Double_Precision_Floating_Point_To_Integer32_
               Truncate(SRC[127:64]);
```

Intel C/C++ Compiler Intrinsic Equivalent

```
CVTTPD1PI__m64 __mm_cvttpd_pi32(__m128d a)
```

SIMD Floating-Point Exceptions

Invalid, Precision.

Protected Mode Exceptions

#GP(0) For an illegal memory operand effective address in the CS, DS, ES, FS or GS segments.

	If a memory operand is not aligned on a 16-byte boundary, regardless of segment.
#SS(0)	For an illegal address in the SS segment.
#PF(fault-code)	For a page fault.
#MF	If there is a pending x87 FPU exception.
#NM	If CR0.TS[bit 3] = 1.
#XM	If an unmasked SIMD floating-point exception and CR4.OSXMMEXCPT[bit 10] = 1.
#UD	If an unmasked SIMD floating-point exception and CR4.OSXMMEXCPT[bit 10] = 0. If CR0.EM[bit 2] = 1. If CR4.OSFXSR[bit 9] = 0. If CPUID.01H:EDX.SSE2[bit 26] = 0. If the LOCK prefix is used.

Real-Address Mode Exceptions

#GP	If a memory operand is not aligned on a 16-byte boundary, regardless of segment. If any part of the operand lies outside the effective address space from 0 to FFFFH.
#NM	If CR0.TS[bit 3] = 1.
#MF	If there is a pending x87 FPU exception.
#XM	If an unmasked SIMD floating-point exception and CR4.OSXMMEXCPT[bit 10] = 1.
#UD	If an unmasked SIMD floating-point exception and CR4.OSXMMEXCPT[bit 10] = 0. If CR0.EM[bit 2] = 1. If CR4.OSFXSR[bit 9] = 0. If CPUID.01H:EDX.SSE2[bit 26] = 0. If the LOCK prefix is used.

Virtual-8086 Mode Exceptions

Same exceptions as in real address mode.

#PF(fault-code)	For a page fault.
-----------------	-------------------

Compatibility Mode Exceptions

Same exceptions as in protected mode.

64-Bit Mode Exceptions

#SS(0)	If a memory address referencing the SS segment is in a non-canonical form.
#GP(0)	If the memory address is in a non-canonical form. If memory operand is not aligned on a 16-byte boundary, regardless of segment.
#PF(fault-code)	For a page fault.
#NM	If CR0.TS[bit 3] = 1.
#XM	If an unmasked SIMD floating-point exception and CR4.OSXMMEXCPT[bit 10] = 1.
#UD	If an unmasked SIMD floating-point exception and CR4.OSXMMEXCPT[bit 10] = 0. If CR0.EM[bit 2] = 1. If CR4.OSFXSR[bit 9] = 0. If CPUID.01H:EDX.SSE2[bit 26] = 0. If the LOCK prefix is used.

CVTTPS2DQ—Convert with Truncation Packed Single-Precision FP Values to Packed Dword Integers

Opcode	Instruction	64-Bit Mode	Compat/ Leg Mode	Description
F3 0F 5B /r	CVTTPS2DQ <i>xmm1</i> , <i>xmm2/m128</i>	Valid	Valid	Convert four single-precision floating-point values from <i>xmm2/m128</i> to four signed doubleword integers in <i>xmm1</i> using truncation.

Description

Converts four packed single-precision floating-point values in the source operand (second operand) to four packed signed doubleword integers in the destination operand (first operand). The source operand can be an XMM register or a 128-bit memory location. The destination operand is an XMM register. When a conversion is inexact, a truncated (round toward zero) result is returned. If a converted result is larger than the maximum signed doubleword integer, the floating-point invalid exception is raised, and if this exception is masked, the indefinite integer value (80000000H) is returned.

In 64-bit mode, use of the REX.R prefix permits this instruction to access additional registers (XMM8-XMM15).

Operation

```
DEST[31:0] ← Convert_Single_Precision_Floating_Point_To_Integer_Truncate(SRC[31:0]);
DEST[63:32] ← Convert_Single_Precision_Floating_Point_To_Integer_Truncate(SRC[63:32]);
DEST[95:64] ← Convert_Single_Precision_Floating_Point_To_Integer_Truncate(SRC[95:64]);
DEST[127:96] ← Convert_Single_Precision_Floating_Point_To_Integer_Truncate(SRC[127:96]);
```

Intel C/C++ Compiler Intrinsic Equivalent

```
CVTTPS2DQ    __m128i _mm_cvttps_epi32(__m128 a)
```

SIMD Floating-Point Exceptions

Invalid, Precision.

Protected Mode Exceptions

- #GP(0) For an illegal memory operand effective address in the CS, DS, ES, FS or GS segments.
If a memory operand is not aligned on a 16-byte boundary, regardless of segment.
- #SS(0) For an illegal address in the SS segment.

#PF(fault-code)	For a page fault.
#NM	If CR0.TS[bit 3] = 1.
#XM	If an unmasked SIMD floating-point exception and CR4.OSXMMEXCPT[bit 10] = 1.
#UD	If an unmasked SIMD floating-point exception and CR4.OSXMMEXCPT[bit 10] = 0. If CR0.EM[bit 2] = 1. If CR4.OSFXSR[bit 9] = 0. If CPUID.01H:EDX.SSE2[bit 26] = 0. If the LOCK prefix is used.

Real-Address Mode Exceptions

#GP	If a memory operand is not aligned on a 16-byte boundary, regardless of segment. If any part of the operand lies outside the effective address space from 0 to FFFFH.
#NM	If CR0.TS[bit 3] = 1.
#XM	If an unmasked SIMD floating-point exception and CR4.OSXMMEXCPT[bit 10] = 1.
#UD	If an unmasked SIMD floating-point exception and CR4.OSXMMEXCPT[bit 10] = 0. If CR0.EM[bit 2] = 1. If CR4.OSFXSR[bit 9] = 0. If CPUID.01H:EDX.SSE2[bit 26] = 0. If the LOCK prefix is used.

Virtual-8086 Mode Exceptions

Same exceptions as in real address mode.

#PF(fault-code)	For a page fault.
-----------------	-------------------

Compatibility Mode Exceptions

Same exceptions as in protected mode.

64-Bit Mode Exceptions

#SS(0)	If a memory address referencing the SS segment is in a non-canonical form.
#GP(0)	If the memory address is in a non-canonical form. If memory operand is not aligned on a 16-byte boundary, regardless of segment.

#PF(fault-code)	For a page fault.
#NM	If CR0.TS[bit 3] = 1.
#XM	If an unmasked SIMD floating-point exception and CR4.OSXMMEXCPT[bit 10] = 1.
#UD	If an unmasked SIMD floating-point exception and CR4.OSXMMEXCPT[bit 10] = 0. If CR0.EM[bit 2] = 1. If CR4.OSFXSR[bit 9] = 0. If CPUID.01H:EDX.SSE2[bit 26] = 0. If the LOCK prefix is used.

CVTTPS2PI—Convert with Truncation Packed Single-Precision FP Values to Packed Dword Integers

Opcode	Instruction	64-Bit Mode	Compat/Leg Mode	Description
OF 2C /r	CVTTPS2PI <i>mm, xmm/m64</i>	Valid	Valid	Convert two single-precision floating-point values from <i>xmm/m64</i> to two signed doubleword integers in <i>mm</i> using truncation.

Description

Converts two packed single-precision floating-point values in the source operand (second operand) to two packed signed doubleword integers in the destination operand (first operand). The source operand can be an XMM register or a 64-bit memory location. The destination operand is an MMX technology register. When the source operand is an XMM register, the two single-precision floating-point values are contained in the low quadword of the register.

When a conversion is inexact, a truncated (round toward zero) result is returned. If a converted result is larger than the maximum signed doubleword integer, the floating-point invalid exception is raised, and if this exception is masked, the indefinite integer value (80000000H) is returned.

This instruction causes a transition from x87 FPU to MMX technology operation (that is, the x87 FPU top-of-stack pointer is set to 0 and the x87 FPU tag word is set to all 0s [valid]). If this instruction is executed while an x87 FPU floating-point exception is pending, the exception is handled before the CVTTPS2PI instruction is executed.

In 64-bit mode, use of the REX.R prefix permits this instruction to access additional registers (XMM8-XMM15).

Operation

```
DEST[31:0] ← Convert_Single_Precision_Floating_Point_To_Integer_Truncate(SRC[31:0]);
DEST[63:32] ← Convert_Single_Precision_Floating_Point_To_Integer_Truncate(SRC[63:32]);
```

Intel C/C++ Compiler Intrinsic Equivalent

```
CVTTPS2PI    __m64 __mm_cvttps_pi32(__m128 a)
```

SIMD Floating-Point Exceptions

Invalid, Precision.

Protected Mode Exceptions

#GP(0)	For an illegal memory operand effective address in the CS, DS, ES, FS or GS segments.
#SS(0)	For an illegal address in the SS segment.
#PF(fault-code)	For a page fault.
#MF	If there is a pending x87 FPU exception.
#NM	If CR0.TS[bit 3] = 1.
#XM	If an unmasked SIMD floating-point exception and CR4.OSXMMEXCPT[bit 10] = 1.
#UD	If an unmasked SIMD floating-point exception and CR4.OSXMMEXCPT[bit 10] = 0. If CR0.EM[bit 2] = 1. If CR4.OSFXSR[bit 9] = 0. If CPUID.01H: EDX.SSE[bit 25] = 0. If the LOCK prefix is used.
#AC(0)	If alignment checking is enabled and an unaligned memory reference is made while the current privilege level is 3.

Real-Address Mode Exceptions

GP	If any part of the operand lies outside the effective address space from 0 to FFFFH.
#NM	If CR0.TS[bit 3] = 1.
#MF	If there is a pending x87 FPU exception.
#XM	If an unmasked SIMD floating-point exception and CR4.OSXMMEXCPT[bit 10] = 1.
#UD	If an unmasked SIMD floating-point exception and CR4.OSXMMEXCPT[bit 10] = 0. If CR0.EM[bit 2] = 1. If CR4.OSFXSR[bit 9] = 0. If CPUID.01H: EDX.SSE[bit 25] = 0. If the LOCK prefix is used.

Virtual-8086 Mode Exceptions

Same exceptions as in real address mode.

#PF(fault-code)	For a page fault.
#AC(0)	If alignment checking is enabled and an unaligned memory reference is made.

Compatibility Mode Exceptions

Same exceptions as in protected mode.

64-Bit Mode Exceptions

#SS(0)	If a memory address referencing the SS segment is in a non-canonical form.
#GP(0)	If the memory address is in a non-canonical form.
#PF(fault-code)	For a page fault.
#NM	If $\text{CR0.TS}[\text{bit } 3] = 1$.
#MF	If there is a pending x87 FPU exception.
#XM	If an unmasked SIMD floating-point exception and $\text{CR4.OSXMMEXCPT}[\text{bit } 10] = 1$.
#UD	If an unmasked SIMD floating-point exception and $\text{CR4.OSXMMEXCPT}[\text{bit } 10] = 0$. If $\text{CR0.EM}[\text{bit } 2] = 1$. If $\text{CR4.OSFXSR}[\text{bit } 9] = 0$. If $\text{CPUID.01H:EDX.SSE}[\text{bit } 25] = 0$. If the LOCK prefix is used.
#AC(0)	If alignment checking is enabled and an unaligned memory reference is made while the current privilege level is 3.

CVTTSD2SI—Convert with Truncation Scalar Double-Precision FP Value to Signed Integer

Opcode	Instruction	64-Bit Mode	Compat/Leg Mode	Description
F2 0F 2C /r	CVTTSD2SI <i>r32</i> , <i>xmm/m64</i>	Valid	Valid	Convert one double-precision floating-point value from <i>xmm/m64</i> to one signed doubleword integer in <i>r32</i> using truncation.
F2 REX.W 0F 2C /r	CVTTSD2SI <i>r64</i> , <i>xmm/m64</i>	Valid	N.E.	Convert one double precision floating-point value from <i>xmm/m64</i> to one signed quadword integer in <i>r64</i> using truncation.

Description

Converts a double-precision floating-point value in the source operand (second operand) to a signed doubleword integer (or signed quadword integer if operand size is 64 bits) in the destination operand (first operand). The source operand can be an XMM register or a 64-bit memory location. The destination operand is a general-purpose register. When the source operand is an XMM register, the double-precision floating-point value is contained in the low quadword of the register.

When a conversion is inexact, a truncated (round toward zero) result is returned. If a converted result is larger than the maximum signed doubleword integer, the floating-point invalid exception is raised. If this exception is masked, the indefinite integer value (80000000H) is returned.

In 64-bit mode, the instruction can access additional registers (XMM8-XMM15, R8-R15) when used with a REX.R prefix. Use of the REX.W prefix promotes the instruction to 64-bit operation. See the summary chart at the beginning of this section for encoding data and limits.

Operation

```
IF 64-Bit Mode and OperandSize = 64
  THEN
    DEST[63:0] ← Convert_Double_Precision_Floating_Point_To_
                Integer64_Truncate(SRC[63:0]);
  ELSE
    DEST[31:0] ← Convert_Double_Precision_Floating_Point_To_
                Integer32_Truncate(SRC[63:0]);
FI;
```

Intel C/C++ Compiler Intrinsic Equivalent

`int __mm_cvttsd_si32(__m128d a)`

SIMD Floating-Point Exceptions

Invalid, Precision.

Protected Mode Exceptions

#GP(0)	For an illegal memory operand effective address in the CS, DS, ES, FS or GS segments.
#SS(0)	For an illegal address in the SS segment.
#PF(fault-code)	For a page fault.
#NM	If CR0.TS[bit 3] = 1.
#XM	If an unmasked SIMD floating-point exception and CR4.OSXMMEXCPT[bit 10] = 1.
#UD	If an unmasked SIMD floating-point exception and CR4.OSXMMEXCPT[bit 10] = 0. If CR0.EM[bit 2] = 1. If CR4.OSFXSR[bit 9] = 0. If CPUID.01H:EDX.SSE2[bit 26] = 0. If the LOCK prefix is used.
#AC(0)	If alignment checking is enabled and an unaligned memory reference is made while the current privilege level is 3.

Real-Address Mode Exceptions

GP	If any part of the operand lies outside the effective address space from 0 to FFFFH.
#NM	If CR0.TS[bit 3] = 1.
#XM	If an unmasked SIMD floating-point exception and CR4.OSXMMEXCPT[bit 10] = 1.
#UD	If an unmasked SIMD floating-point exception and CR4.OSXMMEXCPT[bit 10] = 0. If CR0.EM[bit 2] = 1. If CR4.OSFXSR[bit 9] = 0. If CPUID.01H:EDX.SSE2[bit 26] = 0. If the LOCK prefix is used.

Virtual-8086 Mode Exceptions

Same exceptions as in real address mode.

#PF(fault-code)	For a page fault.
-----------------	-------------------

#AC(0) If alignment checking is enabled and an unaligned memory reference is made.

Compatibility Mode Exceptions

Same exceptions as in protected mode.

64-Bit Mode Exceptions

#SS(0) If a memory address referencing the SS segment is in a non-canonical form.

#GP(0) If the memory address is in a non-canonical form.

#PF(fault-code) For a page fault.

#NM If $\text{CR0.TS}[\text{bit } 3] = 1$.

#XM If an unmasked SIMD floating-point exception and $\text{CR4.OSXMMEXCPT}[\text{bit } 10] = 1$.

#UD If an unmasked SIMD floating-point exception and $\text{CR4.OSXMMEXCPT}[\text{bit } 10] = 0$.
If $\text{CR0.EM}[\text{bit } 2] = 1$.
If $\text{CR4.OSFXSR}[\text{bit } 9] = 0$.
If $\text{CPUID.01H:EDX.SSE2}[\text{bit } 26] = 0$.
If the LOCK prefix is used.

#AC(0) If alignment checking is enabled and an unaligned memory reference is made while the current privilege level is 3.

CVTTSS2SI—Convert with Truncation Scalar Single-Precision FP Value to Dword Integer

Opcode	Instruction	64-Bit Mode	Compat/Leg Mode	Description
F3 OF 2C /r	CVTTSS2SI <i>r32</i> , <i>xmm/m32</i>	Valid	Valid	Convert one single-precision floating-point value from <i>xmm/m32</i> to one signed doubleword integer in <i>r32</i> using truncation.
F3 REX.W OF 2C /r	CVTTSS2SI <i>r64</i> , <i>xmm/m32</i>	Valid	N.E.	Convert one single-precision floating-point value from <i>xmm/m32</i> to one signed quadword integer in <i>r64</i> using truncation.

Description

Converts a single-precision floating-point value in the source operand (second operand) to a signed doubleword integer (or signed quadword integer if operand size is 64 bits) in the destination operand (first operand). The source operand can be an XMM register or a 32-bit memory location. The destination operand is a general-purpose register. When the source operand is an XMM register, the single-precision floating-point value is contained in the low doubleword of the register.

When a conversion is inexact, a truncated (round toward zero) result is returned. If a converted result is larger than the maximum signed doubleword integer, the floating-point invalid exception is raised. If this exception is masked, the indefinite integer value (80000000H) is returned.

In 64-bit mode, the instruction can access additional registers (XMM8-XMM15, R8-R15) when used with a REX.R prefix. Use of the REX.W prefix promotes the instruction to 64-bit operation. See the summary chart at the beginning of this section for encoding data and limits.

Operation

```
IF 64-Bit Mode and OperandSize = 64
  THEN
    DEST[63:0] ← Convert_Single_Precision_Floating_Point_To_
                Integer_Truncate(SRC[31:0]);
  ELSE
    DEST[31:0] ← Convert_Single_Precision_Floating_Point_To_
                Integer_Truncate(SRC[31:0]);
FI;
```

Intel C/C++ Compiler Intrinsic Equivalent

`int _mm_cvtts_si32(__m128d a)`

SIMD Floating-Point Exceptions

Invalid, Precision.

Protected Mode Exceptions

#GP(0)	For an illegal memory operand effective address in the CS, DS, ES, FS or GS segments.
#SS(0)	For an illegal address in the SS segment.
#PF(fault-code)	For a page fault.
#NM	If CR0.TS[bit 3] = 1.
#XM	If an unmasked SIMD floating-point exception and CR4.OSXMMEXCPT[bit 10] = 1.
#UD	If an unmasked SIMD floating-point exception and CR4.OSXMMEXCPT[bit 10] = 0. If CR0.EM[bit 2] = 1. If CR4.OSFXSR[bit 9] = 0. If CPUID.01H:EDX.SSE[bit 25] = 0. If the LOCK prefix is used.
#AC(0)	If alignment checking is enabled and an unaligned memory reference is made while the current privilege level is 3.

Real-Address Mode Exceptions

GP	If any part of the operand lies outside the effective address space from 0 to FFFFH.
#NM	If CR0.TS[bit 3] = 1.
#XM	If an unmasked SIMD floating-point exception and CR4.OSXMMEXCPT[bit 10] = 1.
#UD	If an unmasked SIMD floating-point exception and CR4.OSXMMEXCPT[bit 10] = 0. If CR0.EM[bit 2] = 1. If CR4.OSFXSR[bit 9] = 0. If CPUID.01H:EDX.SSE[bit 25] = 0. If the LOCK prefix is used.

Virtual-8086 Mode Exceptions

Same exceptions as in real address mode.

#PF(fault-code)	For a page fault.
-----------------	-------------------

#AC(0) If alignment checking is enabled and an unaligned memory reference is made.

Compatibility Mode Exceptions

Same exceptions as in protected mode.

64-Bit Mode Exceptions

#SS(0) If a memory address referencing the SS segment is in a non-canonical form.

#GP(0) If the memory address is in a non-canonical form.

#PF(fault-code) For a page fault.

#NM If $\text{CR0.TS}[\text{bit } 3] = 1$.

#XM If an unmasked SIMD floating-point exception and $\text{CR4.OSXMMEXCPT}[\text{bit } 10] = 1$.

#UD If an unmasked SIMD floating-point exception and $\text{CR4.OSXMMEXCPT}[\text{bit } 10] = 0$.
If $\text{CR0.EM}[\text{bit } 2] = 1$.
If $\text{CR4.OSFXSR}[\text{bit } 9] = 0$.
If $\text{CPUID.01H:EDX.SSE}[\text{bit } 25] = 0$.
If the LOCK prefix is used.

#AC(0) If alignment checking is enabled and an unaligned memory reference is made while the current privilege level is 3.

CWD/CDQ/CQO—Convert Word to Doubleword/Convert Doubleword to Quadword

Opcode	Instruction	64-Bit Mode	Compat/Leg Mode	Description
99	CWD	Valid	Valid	DX:AX ← sign-extend of AX.
99	CDQ	Valid	Valid	EDX:EAX ← sign-extend of EAX.
REX.W + 99	CQO	Valid	N.E.	RDX:RAX ← sign-extend of RAX.

Description

Doubles the size of the operand in register AX, EAX, or RAX (depending on the operand size) by means of sign extension and stores the result in registers DX:AX, EDX:EAX, or RDX:RAX, respectively. The CWD instruction copies the sign (bit 15) of the value in the AX register into every bit position in the DX register. The CDQ instruction copies the sign (bit 31) of the value in the EAX register into every bit position in the EDX register. The CQO instruction (available in 64-bit mode only) copies the sign (bit 63) of the value in the RAX register into every bit position in the RDX register.

The CWD instruction can be used to produce a doubleword dividend from a word before word division. The CDQ instruction can be used to produce a quadword dividend from a doubleword before doubleword division. The CQO instruction can be used to produce a double quadword dividend from a quadword before a quadword division.

The CWD and CDQ mnemonics reference the same opcode. The CWD instruction is intended for use when the operand-size attribute is 16 and the CDQ instruction for when the operand-size attribute is 32. Some assemblers may force the operand size to 16 when CWD is used and to 32 when CDQ is used. Others may treat these mnemonics as synonyms (CWD/CDQ) and use the current setting of the operand-size attribute to determine the size of values to be converted, regardless of the mnemonic used.

In 64-bit mode, use of the REX.W prefix promotes operation to 64 bits. The CQO mnemonics reference the same opcode as CWD/CDQ. See the summary chart at the beginning of this section for encoding data and limits.

Operation

```
IF OperandSize = 16 (* CWD instruction *)
  THEN
    DX ← SignExtend(AX);
  ELSE IF OperandSize = 32 (* CDQ instruction *)
    EDX ← SignExtend(EAX); FI;
  ELSE IF 64-Bit Mode and OperandSize = 64 (* CQO instruction*)
```

$RDX \leftarrow \text{SignExtend}(RAX); FI;$
FI;

Flags Affected

None.

Exceptions (All Operating Modes)

#UD If the LOCK prefix is used.

DAA—Decimal Adjust AL after Addition

Opcode	Instruction	64-Bit Mode	Compat/ Leg Mode	Description
27	DAA	Invalid	Valid	Decimal adjust AL after addition.

Description

Adjusts the sum of two packed BCD values to create a packed BCD result. The AL register is the implied source and destination operand. The DAA instruction is only useful when it follows an ADD instruction that adds (binary addition) two 2-digit, packed BCD values and stores a byte result in the AL register. The DAA instruction then adjusts the contents of the AL register to contain the correct 2-digit, packed BCD result. If a decimal carry is detected, the CF and AF flags are set accordingly.

This instruction executes as described above in compatibility mode and legacy mode. It is not valid in 64-bit mode.

Operation

IF 64-Bit Mode

THEN

#UD;

ELSE

old_AL ← AL;

old_CF ← CF;

CF ← 0;

IF (((AL AND 0FH) > 9) or AF = 1)

THEN

AL ← AL + 6;

CF ← old_CF or (Carry from AL ← AL + 6);

AF ← 1;

ELSE

AF ← 0;

FI;

IF ((old_AL > 99H) or (old_CF = 1))

THEN

AL ← AL + 60H;

CF ← 1;

ELSE

CF ← 0;

FI;

FI;

Example

```

ADD    AL, BL    Before: AL=79H BL=35H EFLAGS(OSZAPC)=XXXXXX
                After: AL=AEH BL=35H EFLAGS(OSZAPC)=110000
DAA                    Before: AL=AEH BL=35H EFLAGS(OSZAPC)=110000
                After: AL=14H BL=35H EFLAGS(OSZAPC)=X00111
DAA                    Before: AL=2EH BL=35H EFLAGS(OSZAPC)=110000
                After: AL=34H BL=35H EFLAGS(OSZAPC)=X00101

```

Flags Affected

The CF and AF flags are set if the adjustment of the value results in a decimal carry in either digit of the result (see the “Operation” section above). The SF, ZF, and PF flags are set according to the result. The OF flag is undefined.

Protected Mode Exceptions

#UD If the LOCK prefix is used.

Real-Address Mode Exceptions

#UD If the LOCK prefix is used.

Virtual-8086 Mode Exceptions

#UD If the LOCK prefix is used.

Compatibility Mode Exceptions

#UD If the LOCK prefix is used.

64-Bit Mode Exceptions

#UD If in 64-bit mode.

DAS—Decimal Adjust AL after Subtraction

Opcode	Instruction	64-Bit Mode	Compat/Leg Mode	Description
2F	DAS	Invalid	Valid	Decimal adjust AL after subtraction.

Description

Adjusts the result of the subtraction of two packed BCD values to create a packed BCD result. The AL register is the implied source and destination operand. The DAS instruction is only useful when it follows a SUB instruction that subtracts (binary subtraction) one 2-digit, packed BCD value from another and stores a byte result in the AL register. The DAS instruction then adjusts the contents of the AL register to contain the correct 2-digit, packed BCD result. If a decimal borrow is detected, the CF and AF flags are set accordingly.

This instruction executes as described above in compatibility mode and legacy mode. It is not valid in 64-bit mode.

Operation

```

IF 64-Bit Mode
  THEN
    #UD;
  ELSE
    old_AL ← AL;
    old_CF ← CF;
    CF ← 0;
    IF (((AL AND 0FH) > 9) or AF = 1)
      THEN
        AL ← AL - 6;
        CF ← old_CF or (Borrow from AL ← AL - 6);
        AF ← 1;
      ELSE
        AF ← 0;
    FI;
    IF ((old_AL > 99H) or (old_CF = 1))
      THEN
        AL ← AL - 60H;
        CF ← 1;
    FI;
  FI;

```

Example

SUB	AL, BL	Before: AL = 35H, BL = 47H, EFLAGS(OSZAPC) = XXXXXX After: AL = EEH, BL = 47H, EFLAGS(OSZAPC) = 010111
DAA		Before: AL = EEH, BL = 47H, EFLAGS(OSZAPC) = 010111 After: AL = 88H, BL = 47H, EFLAGS(OSZAPC) = X10111

Flags Affected

The CF and AF flags are set if the adjustment of the value results in a decimal borrow in either digit of the result (see the “Operation” section above). The SF, ZF, and PF flags are set according to the result. The OF flag is undefined.

Protected Mode Exceptions

#UD If the LOCK prefix is used.

Real-Address Mode Exceptions

#UD If the LOCK prefix is used.

Virtual-8086 Mode Exceptions

#UD If the LOCK prefix is used.

Compatibility Mode Exceptions

#UD If the LOCK prefix is used.

64-Bit Mode Exceptions

#UD If in 64-bit mode.

DEC—Decrement by 1

Opcode	Instruction	64-Bit Mode	Compat/ Leg Mode	Description
FE /1	DEC <i>r/m8</i>	Valid	Valid	Decrement <i>r/m8</i> by 1.
REX + FE /1	DEC <i>r/m8</i> *	Valid	N.E.	Decrement <i>r/m8</i> by 1.
FF /1	DEC <i>r/m16</i>	Valid	Valid	Decrement <i>r/m16</i> by 1.
FF /1	DEC <i>r/m32</i>	Valid	Valid	Decrement <i>r/m32</i> by 1.
REX.W + FF /1	DEC <i>r/m64</i>	Valid	N.E.	Decrement <i>r/m64</i> by 1.
48+rw	DEC <i>r16</i>	N.E.	Valid	Decrement <i>r16</i> by 1.
48+rd	DEC <i>r32</i>	N.E.	Valid	Decrement <i>r32</i> by 1.

NOTES:

- * In 64-bit mode, *r/m8* can not be encoded to access the following byte registers if a REX prefix is used: AH, BH, CH, DH.

Description

Subtracts 1 from the destination operand, while preserving the state of the CF flag. The destination operand can be a register or a memory location. This instruction allows a loop counter to be updated without disturbing the CF flag. (To perform a decrement operation that updates the CF flag, use a SUB instruction with an immediate operand of 1.)

This instruction can be used with a LOCK prefix to allow the instruction to be executed atomically.

In 64-bit mode, DEC *r16* and DEC *r32* are not encodable (because opcodes 48H through 4FH are REX prefixes). Otherwise, the instruction's 64-bit mode default operation size is 32 bits. Use of the REX.R prefix permits access to additional registers (R8-R15). Use of the REX.W prefix promotes operation to 64 bits.

See the summary chart at the beginning of this section for encoding data and limits.

Operation

DEST ← DEST - 1;

Flags Affected

The CF flag is not affected. The OF, SF, ZF, AF, and PF flags are set according to the result.

Protected Mode Exceptions

#GP(0)	If the destination operand is located in a non-writable segment. If a memory operand effective address is outside the CS, DS, ES, FS, or GS segment limit. If the DS, ES, FS, or GS register contains a NULL segment selector.
#SS(0)	If a memory operand effective address is outside the SS segment limit.
#PF(fault-code)	If a page fault occurs.
#AC(0)	If alignment checking is enabled and an unaligned memory reference is made while the current privilege level is 3.
#UD	If the LOCK prefix is used but the destination is not a memory operand.

Real-Address Mode Exceptions

#GP	If a memory operand effective address is outside the CS, DS, ES, FS, or GS segment limit.
#SS	If a memory operand effective address is outside the SS segment limit.
#UD	If the LOCK prefix is used but the destination is not a memory operand.

Virtual-8086 Mode Exceptions

#GP(0)	If a memory operand effective address is outside the CS, DS, ES, FS, or GS segment limit.
#SS(0)	If a memory operand effective address is outside the SS segment limit.
#PF(fault-code)	If a page fault occurs.
#AC(0)	If alignment checking is enabled and an unaligned memory reference is made.
#UD	If the LOCK prefix is used but the destination is not a memory operand.

Compatibility Mode Exceptions

Same exceptions as in protected mode.

64-Bit Mode Exceptions

#SS(0)	If a memory address referencing the SS segment is in a non-canonical form.
#GP(0)	If the memory address is in a non-canonical form.
#PF(fault-code)	If a page fault occurs.

#AC(0)	If alignment checking is enabled and an unaligned memory reference is made while the current privilege level is 3.
#UD	If the LOCK prefix is used but the destination is not a memory operand.

DIV—Unsigned Divide

Opcode	Instruction	64-Bit Mode	Compat/ Leg Mode	Description
F6 /6	DIV <i>r/m8</i>	Valid	Valid	Unsigned divide AX by <i>r/m8</i> , with result stored in AL ← Quotient, AH ← Remainder.
REX + F6 /6	DIV <i>r/m8</i> *	Valid	N.E.	Unsigned divide AX by <i>r/m8</i> , with result stored in AL ← Quotient, AH ← Remainder.
F7 /6	DIV <i>r/m16</i>	Valid	Valid	Unsigned divide DX:AX by <i>r/m16</i> , with result stored in AX ← Quotient, DX ← Remainder.
F7 /6	DIV <i>r/m32</i>	Valid	Valid	Unsigned divide EDX:EAX by <i>r/m32</i> , with result stored in EAX ← Quotient, EDX ← Remainder.
REX.W + F7 /6	DIV <i>r/m64</i>	Valid	N.E.	Unsigned divide RDX:RAX by <i>r/m64</i> , with result stored in RAX ← Quotient, RDX ← Remainder.

NOTES:

- * In 64-bit mode, *r/m8* can not be encoded to access the following byte registers if a REX prefix is used: AH, BH, CH, DH.

Description

Divides unsigned the value in the AX, DX:AX, EDX:EAX, or RDX:RAX registers (dividend) by the source operand (divisor) and stores the result in the AX (AH:AL), DX:AX, EDX:EAX, or RDX:RAX registers. The source operand can be a general-purpose register or a memory location. The action of this instruction depends on the operand size (dividend/divisor). Division using 64-bit operand is available only in 64-bit mode.

Non-integral results are truncated (chopped) towards 0. The remainder is always less than the divisor in magnitude. Overflow is indicated with the #DE (divide error) exception rather than with the CF flag.

In 64-bit mode, the instruction's default operation size is 32 bits. Use of the REX.R prefix permits access to additional registers (R8-R15). Use of the REX.W prefix promotes operation to 64 bits. In 64-bit mode when REX.W is applied, the instruction divides the unsigned value in RDX:RAX by the source operand and stores the quotient in RAX, the remainder in RDX.

See the summary chart at the beginning of this section for encoding data and limits. See Table 3-28.

Table 3-28. DIV Action

Operand Size	Dividend	Divisor	Quotient	Remainder	Maximum Quotient
Word/byte	AX	r/m8	AL	AH	255
Doubleword/word	DX:AX	r/m16	AX	DX	65,535
Quadword/doubleword	EDX:EAX	r/m32	EAX	EDX	$2^{32} - 1$
Doublequadword/ quadword	RDX:RAX	r/m64	RAX	RDX	$2^{64} - 1$

Operation

```

IF SRC = 0
    THEN #DE; FI; (* Divide Error *)
IF OperandSize = 8 (* Word/Byte Operation *)
    THEN
        temp ← AX / SRC;
        IF temp > FFH
            THEN #DE; (* Divide error *)
            ELSE
                AL ← temp;
                AH ← AX MOD SRC;
        FI;
    ELSE IF OperandSize = 16 (* Doubleword/word operation *)
        THEN
            temp ← DX:AX / SRC;
            IF temp > FFFFH
                THEN #DE; (* Divide error *)
            ELSE
                AX ← temp;
                DX ← DX:AX MOD SRC;
            FI;
        ELSE IF OperandSize = 32 (* Quadword/doubleword operation *)
        THEN
            temp ← EDX:EAX / SRC;
            IF temp > FFFFFFFFH
                THEN #DE; (* Divide error *)
            ELSE
                EAX ← temp;
                EDX ← EDX:EAX MOD SRC;
            FI;
        FI;

```

```

ELSE IF 64-Bit Mode and Operandsize = 64 (* Doublequadword/quadword operation *)
  THEN
    temp ← RDX:RAX / SRC;
    IF temp > FFFFFFFFFFFFFFFFH
      THEN #DE; (* Divide error *)
    ELSE
      RAX ← temp;
      RDX ← RDX:RAX MOD SRC;
    FI;
  FI;
FI;

```

Flags Affected

The CF, OF, SF, ZF, AF, and PF flags are undefined.

Protected Mode Exceptions

#DE	If the source operand (divisor) is 0 If the quotient is too large for the designated register.
#GP(0)	If a memory operand effective address is outside the CS, DS, ES, FS, or GS segment limit. If the DS, ES, FS, or GS register contains a NULL segment selector.
#SS(0)	If a memory operand effective address is outside the SS segment limit.
#PF(fault-code)	If a page fault occurs.
#AC(0)	If alignment checking is enabled and an unaligned memory reference is made while the current privilege level is 3.
#UD	If the LOCK prefix is used.

Real-Address Mode Exceptions

#DE	If the source operand (divisor) is 0. If the quotient is too large for the designated register.
#GP	If a memory operand effective address is outside the CS, DS, ES, FS, or GS segment limit. If the DS, ES, FS, or GS register contains a NULL segment selector.
#SS(0)	If a memory operand effective address is outside the SS segment limit.
#UD	If the LOCK prefix is used.

Virtual-8086 Mode Exceptions

#DE	If the source operand (divisor) is 0. If the quotient is too large for the designated register.
#GP(0)	If a memory operand effective address is outside the CS, DS, ES, FS, or GS segment limit.
#SS	If a memory operand effective address is outside the SS segment limit.
#PF(fault-code)	If a page fault occurs.
#AC(0)	If alignment checking is enabled and an unaligned memory reference is made.
#UD	If the LOCK prefix is used.

Compatibility Mode Exceptions

Same exceptions as in protected mode.

64-Bit Mode Exceptions

#SS(0)	If a memory address referencing the SS segment is in a non-canonical form.
#GP(0)	If the memory address is in a non-canonical form.
#DE	If the source operand (divisor) is 0 If the quotient is too large for the designated register.
#PF(fault-code)	If a page fault occurs.
#AC(0)	If alignment checking is enabled and an unaligned memory reference is made while the current privilege level is 3.
#UD	If the LOCK prefix is used.

DIVPD—Divide Packed Double-Precision Floating-Point Values

Opcode	Instruction	64-Bit Mode	Compat/Leg Mode	Description
66 0F 5E /r	DIVPD <i>xmm1</i> , <i>xmm2/m128</i>	Valid	Valid	Divide packed double-precision floating-point values in <i>xmm1</i> by packed double-precision floating-point values <i>xmm2/m128</i> .

Description

Performs a SIMD divide of the *two* packed double-precision floating-point values in the destination operand (first operand) by the *two* packed double-precision floating-point values in the source operand (second operand), and stores the packed double-precision floating-point results in the destination operand. The source operand can be an XMM register or a 128-bit memory location. The destination operand is an XMM register. See Chapter 11 in the *Intel® 64 and IA-32 Architectures Software Developer's Manual, Volume 1*, for an overview of a SIMD double-precision floating-point operation.

In 64-bit mode, use of the REX.R prefix permits this instruction to access additional registers (XMM8-XMM15).

Operation

```
DEST[63:0] ← DEST[63:0] / (SRC[63:0]);
DEST[127:64] ← DEST[127:64] / (SRC[127:64]);
```

Intel C/C++ Compiler Intrinsic Equivalent

```
DIVPD    __m128d _mm_div_pd(__m128d a, __m128d b)
```

SIMD Floating-Point Exceptions

Overflow, Underflow, Invalid, Divide-by-Zero, Precision, Denormal.

Protected Mode Exceptions

#GP(0)	For an illegal memory operand effective address in the CS, DS, ES, FS or GS segments. If a memory operand is not aligned on a 16-byte boundary, regardless of segment.
#SS(0)	For an illegal address in the SS segment.
#PF(fault-code)	For a page fault.
#NM	If CR0.TS[bit 3] = 1.

#XM	If an unmasked SIMD floating-point exception and CR4.OSXMMEXCPT[bit 10] = 1.
#UD	If an unmasked SIMD floating-point exception and CR4.OSXMMEXCPT[bit 10] = 0. If CR0.EM[bit 2] = 1. If CR4.OSFXSR[bit 9] = 0. If CPUID.01H:EDX.SSE2[bit 26] = 0. If the LOCK prefix is used.

Real-Address Mode Exceptions

#GP	If a memory operand is not aligned on a 16-byte boundary, regardless of segment. If any part of the operand lies outside the effective address space from 0 to FFFFH.
#NM	If CR0.TS[bit 3] = 1.
#XM	If an unmasked SIMD floating-point exception and CR4.OSXMMEXCPT[bit 10] = 1.
#UD	If an unmasked SIMD floating-point exception and CR4.OSXMMEXCPT[bit 10] = 0. If CR0.EM[bit 2] = 1. If CR4.OSFXSR[bit 9] = 0. If CPUID.01H:EDX.SSE2[bit 26] = 0. If the LOCK prefix is used.

Virtual-8086 Mode Exceptions

Same exceptions as in real address mode.

#PF(fault-code) For a page fault.

Compatibility Mode Exceptions

Same exceptions as in protected mode.

64-Bit Mode Exceptions

#SS(0)	If a memory address referencing the SS segment is in a non-canonical form.
#GP(0)	If the memory address is in a non-canonical form. If memory operand is not aligned on a 16-byte boundary, regardless of segment.
#PF(fault-code)	For a page fault.
#NM	If CR0.TS[bit 3] = 1.

#XM	If an unmasked SIMD floating-point exception and CR4.OSXMMEXCPT[bit 10] = 1.
#UD	If an unmasked SIMD floating-point exception and CR4.OSXMMEXCPT[bit 10] = 0. If CR0.EM[bit 2] = 1. If CR4.OSFXSR[bit 9] = 0. If CPUID.01H: EDX.SSE2[bit 26] = 0. If the LOCK prefix is used.

DIVPS—Divide Packed Single-Precision Floating-Point Values

Opcode	Instruction	64-Bit Mode	Compat/Leg Mode	Description
OF 5E /r	DIVPS <i>xmm1</i> , <i>xmm2/m128</i>	Valid	Valid	Divide packed single-precision floating-point values in <i>xmm1</i> by packed single-precision floating-point values <i>xmm2/m128</i> .

Description

Performs a SIMD divide of the *four* packed single-precision floating-point values in the destination operand (first operand) by the *four* packed single-precision floating-point values in the source operand (second operand), and stores the packed single-precision floating-point results in the destination operand. The source operand can be an XMM register or a 128-bit memory location. The destination operand is an XMM register. See Chapter 10 in the *Intel® 64 and IA-32 Architectures Software Developer's Manual, Volume 1*, for an overview of a SIMD single-precision floating-point operation.

In 64-bit mode, use of the REX.R prefix permits this instruction to access additional registers (XMM8-XMM15).

Operation

```
DEST[31:0] ← DEST[31:0] / (SRC[31:0]);
DEST[63:32] ← DEST[63:32] / (SRC[63:32]);
DEST[95:64] ← DEST[95:64] / (SRC[95:64]);
DEST[127:96] ← DEST[127:96] / (SRC[127:96]);
```

Intel C/C++ Compiler Intrinsic Equivalent

```
DIVPS    __m128 _mm_div_ps(__m128 a, __m128 b)
```

SIMD Floating-Point Exceptions

Overflow, Underflow, Invalid, Divide-by-Zero, Precision, Denormal.

Protected Mode Exceptions

- #GP(0) For an illegal memory operand effective address in the CS, DS, ES, FS or GS segments.
If a memory operand is not aligned on a 16-byte boundary, regardless of segment.
- #SS(0) For an illegal address in the SS segment.
- #PF(fault-code) For a page fault.

#NM	If CR0.TS[bit 3] = 1.
#XM	If an unmasked SIMD floating-point exception and CR4.OSXMMEXCPT[bit 10] = 1.
#UD	If an unmasked SIMD floating-point exception and CR4.OSXMMEXCPT[bit 10] = 0. If CR0.EM[bit 2] = 1. If CR4.OSFXSR[bit 9] = 0. If CPUID.01H:EDX.SSE[bit 25] = 0. If the LOCK prefix is used.

Real-Address Mode Exceptions

#GP	If a memory operand is not aligned on a 16-byte boundary, regardless of segment. If any part of the operand lies outside the effective address space from 0 to FFFFH.
#NM	If CR0.TS[bit 3] = 1.
#XM	If an unmasked SIMD floating-point exception and CR4.OSXMMEXCPT[bit 10] = 1.
#UD	If an unmasked SIMD floating-point exception and CR4.OSXMMEXCPT[bit 10] = 0. If CR0.EM[bit 2] = 1. If CR4.OSFXSR[bit 9] = 0. If CPUID.01H:EDX.SSE[bit 25] = 0. If the LOCK prefix is used.

Virtual-8086 Mode Exceptions

Same exceptions as in real address mode.

#PF(fault-code) For a page fault.

Compatibility Mode Exceptions

Same exceptions as in protected mode.

64-Bit Mode Exceptions

#SS(0)	If a memory address referencing the SS segment is in a non-canonical form.
#GP(0)	If the memory address is in a non-canonical form. If memory operand is not aligned on a 16-byte boundary, regardless of segment.
#PF(fault-code)	For a page fault.

#NM	If CR0.TS[bit 3] = 1.
#XM	If an unmasked SIMD floating-point exception and CR4.OSXMMEXCPT[bit 10] = 1.
#UD	If an unmasked SIMD floating-point exception and CR4.OSXMMEXCPT[bit 10] = 0. If CR0.EM[bit 2] = 1. If CR4.OSFXSR[bit 9] = 0. If CPUID.01H: EDX.SSE[bit 25] = 0. If the LOCK prefix is used.

DIVSD—Divide Scalar Double-Precision Floating-Point Values

Opcode	Instruction	64-Bit Mode	Compat/Leg Mode	Description
F2 0F 5E /r	DIVSD <i>xmm1</i> , <i>xmm2/mem64</i>	Valid	Valid	Divide low double-precision floating-point value in <i>xmm1</i> by low double-precision floating-point value in <i>xmm2/mem64</i> .

Description

Divides the low double-precision floating-point value in the destination operand (first operand) by the low double-precision floating-point value in the source operand (second operand), and stores the double-precision floating-point result in the destination operand. The source operand can be an XMM register or a 64-bit memory location. The destination operand is an XMM register. The high quadword of the destination operand remains unchanged. See Chapter 11 in the *Intel® 64 and IA-32 Architectures Software Developer's Manual, Volume 1*, for an overview of a scalar double-precision floating-point operation.

In 64-bit mode, use of the REX.R prefix permits this instruction to access additional registers (XMM8-XMM15).

Operation

DEST[63:0] ← DEST[63:0] / SRC[63:0];
(* DEST[127:64] unchanged *)

Intel C/C++ Compiler Intrinsic Equivalent

DIVSD __m128d _mm_div_sd (m128d a, m128d b)

SIMD Floating-Point Exceptions

Overflow, Underflow, Invalid, Divide-by-Zero, Precision, Denormal.

Protected Mode Exceptions

#GP(0)	For an illegal memory operand effective address in the CS, DS, ES, FS or GS segments.
#SS(0)	For an illegal address in the SS segment.
#PF(fault-code)	For a page fault.
#NM	If CR0.TS[bit 3] = 1.
#XM	If an unmasked SIMD floating-point exception and CR4.OSXMMEXCPT[bit 10] = 1.
#UD	If an unmasked SIMD floating-point exception and CR4.OSXMMEXCPT[bit 10] = 0.

	If CR0.EM[bit 2] = 1.
	If CR4.OSFXSR[bit 9] = 0.
	If CPUID.01H:EDX.SSE2[bit 26] = 0.
	If the LOCK prefix is used.
#AC(0)	If alignment checking is enabled and an unaligned memory reference is made while the current privilege level is 3.

Real-Address Mode Exceptions

GP	If any part of the operand lies outside the effective address space from 0 to FFFFH.
#NM	If CR0.TS[bit 3] = 1.
#XM	If an unmasked SIMD floating-point exception and CR4.OSXMMEXCPT[bit 10] = 1.
#UD	If an unmasked SIMD floating-point exception and CR4.OSXMMEXCPT[bit 10] = 0. If CR0.EM[bit 2] = 1. If CR4.OSFXSR[bit 9] = 0. If CPUID.01H:EDX.SSE2[bit 26] = 0. If the LOCK prefix is used.

Virtual-8086 Mode Exceptions

Same exceptions as in real address mode.

#PF(fault-code)	For a page fault.
#AC(0)	If alignment checking is enabled and an unaligned memory reference is made.

Compatibility Mode Exceptions

Same exceptions as in protected mode.

64-Bit Mode Exceptions

#SS(0)	If a memory address referencing the SS segment is in a non-canonical form.
#GP(0)	If the memory address is in a non-canonical form.
#PF(fault-code)	For a page fault.
#NM	If CR0.TS[bit 3] = 1.
#XM	If an unmasked SIMD floating-point exception and CR4.OSXMMEXCPT[bit 10] = 1.
#UD	If an unmasked SIMD floating-point exception and CR4.OSXMMEXCPT[bit 10] = 0.

If CR0.EM[bit 2] = 1.

If CR4.OSFXSR[bit 9] = 0.

If CPUID.01H:EDX.SSE2[bit 26] = 0.

If the LOCK prefix is used.

#AC(0)

If alignment checking is enabled and an unaligned memory reference is made while the current privilege level is 3.

DIVSS—Divide Scalar Single-Precision Floating-Point Values

Opcode	Instruction	64-Bit Mode	Compat/ Leg Mode	Description
F3 0F 5E /r	DIVSS <i>xmm1</i> , <i>xmm2/m32</i>	Valid	Valid	Divide low single-precision floating-point value in <i>xmm1</i> by low single-precision floating-point value in <i>xmm2/m32</i> .

Description

Divides the low single-precision floating-point value in the destination operand (first operand) by the low single-precision floating-point value in the source operand (second operand), and stores the single-precision floating-point result in the destination operand. The source operand can be an XMM register or a 32-bit memory location. The destination operand is an XMM register. The three high-order doublewords of the destination operand remain unchanged. See Chapter 10 in the *Intel® 64 and IA-32 Architectures Software Developer's Manual, Volume 1*, for an overview of a scalar single-precision floating-point operation.

In 64-bit mode, use of the REX.R prefix permits this instruction to access additional registers (XMM8-XMM15).

Operation

DEST[31:0] ← DEST[31:0] / SRC[31:0];
(* DEST[127:32] unchanged *)

Intel C/C++ Compiler Intrinsic Equivalent

DIVSS __m128 _mm_div_ss(__m128 a, __m128 b)

SIMD Floating-Point Exceptions

Overflow, Underflow, Invalid, Divide-by-Zero, Precision, Denormal.

Protected Mode Exceptions

#GP(0)	For an illegal memory operand effective address in the CS, DS, ES, FS or GS segments.
#SS(0)	For an illegal address in the SS segment.
#PF(fault-code)	For a page fault.
#NM	If CR0.TS[bit 3] = 1.
#XM	If an unmasked SIMD floating-point exception and CR4.OSXMMEXCPT[bit 10] = 1.
#UD	If an unmasked SIMD floating-point exception and CR4.OSXMMEXCPT[bit 10] = 0.

	If CR0.EM[bit 2] = 1.
	If CR4.OSFXSR[bit 9] = 0.
	If CPUID.01H: EDX.SSE[bit 25] = 0.
	If the LOCK prefix is used.
#AC(0)	If alignment checking is enabled and an unaligned memory reference is made while the current privilege level is 3.

Real-Address Mode Exceptions

GP	If any part of the operand lies outside the effective address space from 0 to FFFFH.
#NM	If CR0.TS[bit 3] = 1.
#XM	If an unmasked SIMD floating-point exception and CR4.OSXMMEXCPT[bit 10] = 1.
#UD	If an unmasked SIMD floating-point exception and CR4.OSXMMEXCPT[bit 10] = 0. If CR0.EM[bit 2] = 1. If CR4.OSFXSR[bit 9] = 0. If CPUID.01H: EDX.SSE[bit 25] = 0. If the LOCK prefix is used.

Virtual-8086 Mode Exceptions

Same exceptions as in real address mode.

#PF(fault-code)	For a page fault.
#AC(0)	If alignment checking is enabled and an unaligned memory reference is made.

Compatibility Mode Exceptions

Same exceptions as in protected mode.

64-Bit Mode Exceptions

#SS(0)	If a memory address referencing the SS segment is in a non-canonical form.
#GP(0)	If the memory address is in a non-canonical form.
#PF(fault-code)	For a page fault.
#NM	If CR0.TS[bit 3] = 1.
#XM	If an unmasked SIMD floating-point exception and CR4.OSXMMEXCPT[bit 10] = 1.
#UD	If an unmasked SIMD floating-point exception and CR4.OSXMMEXCPT[bit 10] = 0.

If CR0.EM[bit 2] = 1.

If CR4.OSFXSR[bit 9] = 0.

If CPUID.01H:EDX.SSE[bit 25] = 0.

If the LOCK prefix is used.

#AC(0)

If alignment checking is enabled and an unaligned memory reference is made while the current privilege level is 3.

DPPD — Dot Product of Packed Double Precision Floating-Point Values

Opcode	Instruction	64-bit Mode	Compat/ Leg Mode	Description
66 OF 3A 41 /r ib	DPPD <i>xmm1</i> , <i>xmm2/m128</i> , <i>imm8</i>	Valid	Valid	Selectively multiply packed DP floating-point values from <i>xmm1</i> with packed DP floating-point values from <i>xmm2</i> , add and selectively store the packed DP floating-point values to <i>xmm1</i> .

Description

Conditionally multiplies the packed double-precision floating-point values in the destination operand (first operand) with the packed double-precision floating-point values in the source (second operand) depending on a mask extracted from bits [5:4] of the immediate operand (third operand). If a condition mask bit is zero, the corresponding multiplication is replaced by a value of 0.0.

The two resulting double-precision values are summed into an intermediate result. The intermediate result is conditionally broadcasted to the destination using a broadcast mask specified by bits [1:0] of the immediate byte.

If a broadcast mask bit is "1", the intermediate result is copied to the corresponding qword element in the destination operand. If a broadcast mask bit is zero, the corresponding element in the destination is set to zero.

DPPS follows the NaN forwarding rules stated in the Software Developer's Manual, vol. 1, table 4.7. These rules do not cover horizontal prioritization of NaNs. Horizontal propagation of NaNs to the destination and the positioning of those NaNs in the destination is implementation dependent. NaNs on the input sources or computationally generated NaNs will have at least one NaN propagated to the destination.

Operation

```

IF (imm8[4] = 1)
    THEN Temp1[63:0] ← DEST[63:0] * SRC[63:0];
    ELSE Temp1[63:0] ← +0.0; FI;
IF (imm8[5] = 1)
    THEN Temp1[127:64] ← DEST[127:64] * SRC[127:64];
    ELSE Temp1[127:64] ← +0.0; FI;

Temp2[63:0] ← Temp1[63:0] + Temp1[127:64];

IF (imm8[0] = 1)
    THEN DEST[63:0] ← Temp2[63:0];

```

```

ELSE DEST[63:0] ← +0.0; FI;
IF (imm8[1] = 1)
  THEN DEST[127:64] ← Temp2[63:0];
  ELSE DEST[127:64] ← +0.0; FI;

```

Flags Affected

None

Intel C/C++ Compiler Intrinsic Equivalent

DPPD `__m128d _mm_dp_pd (__m128d a, __m128d b, const int mask);`

SIMD Floating-Point Exceptions

Overflow, Underflow, Invalid, Precision, Denormal

Exceptions are determined separately for each add and multiply operation. Unmasked exceptions will leave the destination untouched.

Protected Mode Exceptions

#GP(0)	For an illegal memory operand effective address in the CS, DS, ES, FS, or GS segments. If a memory operand is not aligned on a 16-byte boundary, regardless of segment.
#SS(0)	For an illegal address in the SS segment.
#PF(fault-code)	For a page fault.
#NM	If CR0.TS[bit 3] = 1.
#UD	If an unmasked SIMD floating-point exception and OSXMMEXCPT in CR4 is 0. If CR0.EM[bit 2] = 1. If CR4.OSFXSR[bit 9] = 0. If CPUID.01H:ECX.SSE4_1[bit 19] = 0. If LOCK prefix is used. Either the prefix REP (F3h) or REPN (F2H) is used.
#XM	If an unmasked SIMD floating-point exception and CR4.OSXMMEXCPT[bit 10] = 1.

Real Mode Exceptions

#GP(0)	if any part of the operand lies outside of the effective address space from 0 to 0FFFFH. If a memory operand is not aligned on a 16-byte boundary, regardless of segment.
--------	------------------------------------------------------------------------------------------------------------------------------------------------------------------------------

#NM	If CR0.TS[bit 3] = 1.
#UD	If an unmasked SIMD floating-point exception and OSXMMEXCPT in CR4 is 0. If CR0.EM[bit 2] = 1. If CR4.OSFXSR[bit 9] = 0. If CPUID.01H: ECX.SSE4_1[bit 19] = 0. If LOCK prefix is used. Either the prefix REP (F3h) or REPN (F2H) is used.
#XM	If an unmasked SIMD floating-point exception and CR4.OSXMMEXCPT[bit 10] = 1.

Virtual 8086 Mode Exceptions

Same exceptions as in Real Address Mode.

#PF(fault-code) For a page fault.

Compatibility Mode Exceptions

Same exceptions as in Protected Mode.

64-Bit Mode Exceptions

#GP(0)	If the memory address is in a non-canonical form. If a memory operand is not aligned on a 16-byte boundary, regardless of segment.
#SS(0)	If a memory address referencing the SS segment is in a non-canonical form.
#PF(fault-code)	For a page fault.
#NM	If TS in CR0 is set.
#UD	If an unmasked SIMD floating-point exception and OSXMMEXCPT in CR4 is 0. If EM in CR0 is set. If OSFXSR in CR4 is 0. If CPUID feature flag ECX.SSE4_1 is 0. If LOCK prefix is used. Either the prefix REP (F3h) or REPN (F2H) is used.
#XM	If an unmasked SIMD floating-point exception and CR4.OSXMMEXCPT[bit 10] = 1.

DPPS — Dot Product of Packed Single Precision Floating-Point Values

Opcode	Instruction	64-bit Mode	Compat/ Leg Mode	Description
66 OF 3A 40 /r ib	DPPS <i>xmm1</i> , <i>xmm2/m128</i> , <i>imm8</i>	Valid	Valid	Selectively multiply packed SP floating-point values from <i>xmm1</i> with packed SP floating-point values from <i>xmm2</i> , add and selectively store the packed SP floating-point values or zero values to <i>xmm1</i> .

Description

Conditionally multiplies the packed single precision floating-point values in the destination operand (first operand) with the packed single-precision floats in the source (second operand) depending on a mask extracted from the high 4 bits of the immediate byte (third operand). If a condition mask bit in Imm8[7:4] is zero, the corresponding multiplication is replaced by a value of 0.0.

The four resulting single-precision values are summed into an intermediate result. The intermediate result is conditionally broadcasted to the destination using a broadcast mask specified by bits [3:0] of the immediate byte..

If a broadcast mask bit is "1", the intermediate result is copied to the corresponding dword element in the destination operand. If a broadcast mask bit is zero, the corresponding element in the destination is set to zero.

DPPS follows the NaN forwarding rules stated in the Software Developer's Manual, vol. 1, table 4.7. These rules do not cover horizontal prioritization of NaNs. Horizontal propagation of NaNs to the destination and the positioning of those NaNs in the destination is implementation dependent. NaNs on the input sources or computationally generated NaNs will have at least one NaN propagated to the destination.

Operation

```

IF (imm8[4] == 1)
    THEN Temp1[31:0] ← DEST[31:0] * SRC[31:0];
    ELSE Temp1[31:0] ← +0.0; FI;
IF (imm8[5] == 1)
    THEN Temp1[63:32] ← DEST[63:32] * SRC[63:32];
    ELSE Temp1[63:32] ← +0.0; FI;
IF (imm8[6] == 1)
    THEN Temp1[95:64] ← DEST[95:64] * SRC[95:64];
    ELSE Temp1[95:64] ← +0.0; FI;
IF (imm8[7] == 1)
    THEN Temp1[127:96] ← DEST[127:96] * SRC[127:96];
  
```

ELSE Temp1[127:96] \leftarrow +0.0; FI;

Temp2[31:0] \leftarrow Temp1[31:0] + Temp1[63:32];
 Temp3[31:0] \leftarrow Temp1[95:64] + Temp1[127:96];
 Temp4[31:0] \leftarrow Temp2[31:0] + Temp3[31:0];

IF (imm8[0] == 1)
 THEN DEST[31:0] \leftarrow Temp4[31:0];
 ELSE DEST[31:0] \leftarrow +0.0; FI;
 IF (imm8[1] == 1)
 THEN DEST[63:32] \leftarrow Temp4[31:0];
 ELSE DEST[63:32] \leftarrow +0.0; FI;
 IF (imm8[2] == 1)
 THEN DEST[95:64] \leftarrow Temp4[31:0];
 ELSE DEST[95:64] \leftarrow +0.0; FI;
 IF (imm8[3] == 1)
 THEN DEST[127:96] \leftarrow Temp4[31:0];
 ELSE DEST[127:96] \leftarrow +0.0; FI;

Intel C/C++ Compiler Intrinsic Equivalent

DPPS __m128 __mm_dp_ps (__m128 a, __m128 b, const int mask);

SIMD Floating-Point Exceptions

Overflow, Underflow, Invalid, Precision, Denormal

Exceptions are determined separately for each add and multiply operation, in the order of their execution. Unmasked exceptions will leave the destination operands unchanged.

Protected Mode Exceptions

#GP(0)	For an illegal memory operand effective address in the CS, DS, ES, FS, or GS segments. If a memory operand is not aligned on a 16-byte boundary, regardless of segment.
#SS(0)	For an illegal address in the SS segment.
#PF(fault-code)	For a page fault.
#NM	If CR0.TS[bit 3] = 1.
#UD	If an unmasked SIMD floating-point exception and OSXM-MEXCPT in CR4 is 0. If CR0.EM[bit 2] = 1. If CR4.OSFXSR[bit 9] = 0.

	If CPUID.01H: ECX.SSE4_1[bit 19] = 0.
	If LOCK prefix is used.
	Either the prefix REP (F3h) or REPN (F2H) is used.
#XM	If an unmasked SIMD floating-point exception and CR4.OSXMMEXCPT[bit 10] = 1.

Real Mode Exceptions

#GP(0)	if any part of the operand lies outside of the effective address space from 0 to 0FFFFH. If a memory operand is not aligned on a 16-byte boundary, regardless of segment.
#NM	If CR0.TS[bit 3] = 1.
#UD	If an unmasked SIMD floating-point exception and OSXMMEXCPT in CR4 is 0. If CR0.EM[bit 2] = 1. If CR4.OSFXSR[bit 9] = 0. If CPUID.01H: ECX.SSE4_1[bit 19] = 0. If LOCK prefix is used. Either the prefix REP (F3h) or REPN (F2H) is used.
#XM	If an unmasked SIMD floating-point exception and CR4.OSXMMEXCPT[bit 10] = 1.

Virtual 8086 Mode Exceptions

Same exceptions as in Real Address Mode.

#PF(fault-code)	For a page fault.
-----------------	-------------------

Compatibility Mode Exceptions

Same exceptions as in Protected Mode.

64-Bit Mode Exceptions

#GP(0)	If the memory address is in a non-canonical form. If a memory operand is not aligned on a 16-byte boundary, regardless of segment.
#SS(0)	If a memory address referencing the SS segment is in a non-canonical form.
#PF(fault-code)	For a page fault.
#NM	If TS in CR0 is set.
#UD	If an unmasked SIMD floating-point exception and OSXMMEXCPT in CR4 is 0. If EM in CR0 is set.

#XM

If OSFXSR in CR4 is 0.
If CPUID feature flag ECX.SSE4_1 is 0.
If LOCK prefix is used.
Either the prefix REP (F3h) or REPN (F2H) is used.
If an unmasked SIMD floating-point exception and CR4.OSXMMEXCPT[bit 10] = 1.

EMMS—Empty MMX Technology State

Opcode	Instruction	64-Bit Mode	Compat/ Leg Mode	Description
0F 77	EMMS	Valid	Valid	Set the x87 FPU tag word to empty.

Description

Sets the values of all the tags in the x87 FPU tag word to empty (all 1s). This operation marks the x87 FPU data registers (which are aliased to the MMX technology registers) as available for use by x87 FPU floating-point instructions. (See Figure 8-7 in the *Intel® 64 and IA-32 Architectures Software Developer's Manual, Volume 1*, for the format of the x87 FPU tag word.) All other MMX instructions (other than the EMMS instruction) set all the tags in x87 FPU tag word to valid (all 0s).

The EMMS instruction must be used to clear the MMX technology state at the end of all MMX technology procedures or subroutines and before calling other procedures or subroutines that may execute x87 floating-point instructions. If a floating-point instruction loads one of the registers in the x87 FPU data register stack before the x87 FPU tag word has been reset by the EMMS instruction, an x87 floating-point register stack overflow can occur that will result in an x87 floating-point exception or incorrect result.

EMMS operation is the same in non-64-bit modes and 64-bit mode.

Operation

```
x87FPUTagWord ← FFFFH;
```

Intel C/C++ Compiler Intrinsic Equivalent

```
void _mm_empty()
```

Flags Affected

None.

Protected Mode Exceptions

#UD	If CR0.EM[bit 2] = 1.
#NM	If CR0.TS[bit 3] = 1.
#MF	If there is a pending FPU exception.
#UD	If the LOCK prefix is used.

Real-Address Mode Exceptions

Same exceptions as in protected mode.

Virtual-8086 Mode Exceptions

Same exceptions as in protected mode.

Compatibility Mode Exceptions

Same exceptions as in protected mode.

64-Bit Mode Exceptions

Same exceptions as in protected mode.

ENTER—Make Stack Frame for Procedure Parameters

Opcode	Instruction	64-Bit Mode	Compat/ Leg Mode	Description
C8 iw 00	ENTER <i>imm16, 0</i>	Valid	Valid	Create a stack frame for a procedure.
C8 iw 01	ENTER <i>imm16, 1</i>	Valid	Valid	Create a nested stack frame for a procedure.
C8 iw ib	ENTER <i>imm16, imm8</i>	Valid	Valid	Create a nested stack frame for a procedure.

Description

Creates a stack frame for a procedure. The first operand (size operand) specifies the size of the stack frame (that is, the number of bytes of dynamic storage allocated on the stack for the procedure). The second operand (nesting level operand) gives the lexical nesting level (0 to 31) of the procedure. The nesting level determines the number of stack frame pointers that are copied into the “display area” of the new stack frame from the preceding frame. Both of these operands are immediate values.

The stack-size attribute determines whether the BP (16 bits), EBP (32 bits), or RBP (64 bits) register specifies the current frame pointer and whether SP (16 bits), ESP (32 bits), or RSP (64 bits) specifies the stack pointer. In 64-bit mode, stack-size attribute is always 64-bits.

The ENTER and companion LEAVE instructions are provided to support block structured languages. The ENTER instruction (when used) is typically the first instruction in a procedure and is used to set up a new stack frame for a procedure. The LEAVE instruction is then used at the end of the procedure (just before the RET instruction) to release the stack frame.

If the nesting level is 0, the processor pushes the frame pointer from the BP/EBP/RBP register onto the stack, copies the current stack pointer from the SP/ESP/RSP register into the BP/EBP/RBP register, and loads the SP/ESP/RSP register with the current stack-pointer value minus the value in the size operand. For nesting levels of 1 or greater, the processor pushes additional frame pointers on the stack before adjusting the stack pointer. These additional frame pointers provide the called procedure with access points to other nested frames on the stack. See “Procedure Calls for Block-Structured Languages” in Chapter 6 of the *Intel® 64 and IA-32 Architectures Software Developer’s Manual, Volume 1*, for more information about the actions of the ENTER instruction.

The ENTER instruction causes a page fault whenever a write using the final value of the stack pointer (within the current stack segment) would do so.

In 64-bit mode, default operation size is 64 bits; 32-bit operation size cannot be encoded.

Operation

```

NestingLevel ← NestingLevel MOD 32
IF 64-Bit Mode (StackSize = 64)
  THEN
    Push(RBP);
    FrameTemp ← RSP;
  ELSE IF StackSize = 32
    THEN
      Push(EBP);
      FrameTemp ← ESP; FI;
  ELSE (* StackSize = 16 *)
    Push(BP);
    FrameTemp ← SP;
FI;
IF NestingLevel = 0
  THEN GOTO CONTINUE;
FI;
IF (NestingLevel > 1)
  THEN FOR i ← 1 to (NestingLevel - 1)
    DO
      IF 64-Bit Mode (StackSize = 64)
        THEN
          RBP ← RBP - 8;
          Push([RBP]); (* Quadword push *)
        ELSE IF OperandSize = 32
          THEN
            IF StackSize = 32
              EBP ← EBP - 4;
              Push([EBP]); (* Doubleword push *)
            ELSE (* StackSize = 16 *)
              BP ← BP - 4;
              Push([BP]); (* Doubleword push *)
            FI;
          FI;
        ELSE (* OperandSize = 16 *)
          IF StackSize = 32
            THEN
              EBP ← EBP - 2;
              Push([EBP]); (* Word push *)
            ELSE (* StackSize = 16 *)
              BP ← BP - 2;
              Push([BP]); (* Word push *)
          FI;
        FI;
      FI;
    FI;
  FI;

```

```

                FI;
            FI;
    OD;
FI;
IF 64-Bit Mode (StackSize = 64)
    THEN
        Push(FrameTemp); (* Quadword push *)
    ELSE IF OperandSize = 32
        THEN
            Push(FrameTemp); FI; (* Doubleword push *)
        ELSE (* OperandSize = 16 *)
            Push(FrameTemp); (* Word push *)
FI;
CONTINUE:
IF 64-Bit Mode (StackSize = 64)
    THEN
        RBP ← FrameTemp;
        RSP ← RSP – Size;
    ELSE IF StackSize = 32
        THEN
            EBP ← FrameTemp;
            ESP ← ESP – Size; FI;
    ELSE (* StackSize = 16 *)
        BP ← FrameTemp;
        SP ← SP – Size;
FI;
END;
```

Flags Affected

None.

Protected Mode Exceptions

#SS(0)	If the new value of the SP or ESP register is outside the stack segment limit.
#PF(fault-code)	If a page fault occurs or if a write using the final value of the stack pointer (within the current stack segment) would cause a page fault.
#UD	If the LOCK prefix is used.

Real-Address Mode Exceptions

- #SS If the new value of the SP or ESP register is outside the stack segment limit.
- #UD If the LOCK prefix is used.

Virtual-8086 Mode Exceptions

- #SS(0) If the new value of the SP or ESP register is outside the stack segment limit.
- #PF(fault-code) If a page fault occurs or if a write using the final value of the stack pointer (within the current stack segment) would cause a page fault.
- #UD If the LOCK prefix is used.

Compatibility Mode Exceptions

Same exceptions as in protected mode.

64-Bit Mode Exceptions

- #SS(0) If the stack address is in a non-canonical form.
- #PF(fault-code) If a page fault occurs or if a write using the final value of the stack pointer (within the current stack segment) would cause a page fault.
- #UD If the LOCK prefix is used.

EXTRACTPS – Extract Packed Single Precision Floating-Point Value

Opcode	Instruction	64-bit Mode	Compat/ Leg Mode	Description
66 OF 3A 17 <i>/r ib</i>	EXTRACTPS <i>reg/m32</i> , <i>xmm2, imm8</i>	Valid	Valid	Extract a single-precision floating-point value from <i>xmm2</i> at the source offset specified by <i>imm8</i> and store the result to <i>reg</i> or <i>m32</i> . The upper 32 bits of <i>r64</i> is zeroed if <i>reg</i> is <i>r64</i> .

Description

Extract a single-precision floating-point value from the source *xmm* register (second argument) at an offset determined by $imm8[1:0] * 32$. The extracted single precision floating-point value is stored into the low 32-bits of the destination register or to the 32-bit memory location.

When in 64-bit mode and the destination operand is a general purpose register (GPR), the default operand size is 64 bits. The upper 32 bits of the 64-bit register is filled with zero.

Operation

```
IF (64-Bit Mode and the destination is a GPR )
    THEN
        DEST[31:0] ← (SRC >> (32 * imm8[1:0])) AND 0FFFFFFFh;
        DEST[63:32] ← ZERO_FILL;
    ELSE
        DEST[31:0] ← (SRC >> (32 * imm8[1:0])) AND 0FFFFFFFh;
FI;
```

Intel C/C++ Compiler Intrinsic Equivalent

```
EXTRACTPS    int_mm_extract_ps(__m128 src, const int ndx);
```

SIMD Floating-Point Exceptions

None

Protected Mode Exceptions

- #GP(0) For an illegal memory operand effective address in the CS, DS, ES, FS, or GS segments.
- #SS(0) For an illegal address in the SS segment.

#PF(fault-code)	For a page fault.
#NM	If CR0.TS[bit 3] = 1.
#UD	If CR0.EM[bit 2] = 1. If CR4.OSFXSR[bit 9] = 0. If CPUID.01H: ECX.SSE4_1[bit 19] = 0. If LOCK prefix is used. Either the prefix REP (F3h) or REPN (F2H) is used.
#AC(0)	If alignment checking is enabled and an unaligned memory reference is made while the current privilege level is 3.

Real Mode Exceptions

#GP	if any part of the operand lies outside of the effective address space from 0 to 0FFFFH.
#NM	If CR0.TS[bit 3] = 1.
#UD	If CR0.EM[bit 2] = 1. If CR4.OSFXSR[bit 9] = 0. If CPUID.01H: ECX.SSE4_1[bit 19] = 0. If LOCK prefix is used. Either the prefix REP (F3h) or REPN (F2H) is used.

Virtual 8086 Mode Exceptions

Same exceptions as in Real Address Mode.

#PF(fault-code)	For a page fault.
-----------------	-------------------

Compatibility Mode Exceptions

Same exceptions as in Protected Mode.

64-Bit Mode Exceptions

#GP(0)	If the memory address is in a non-canonical form.
#SS(0)	If a memory address referencing the SS segment is in a non-canonical form.
#PF(fault-code)	For a page fault.
#NM	If TS in CR0 is set.
#UD	If EM in CR0 is set. If OSFXSR in CR4 is 0. If CPUID feature flag ECX.SSE4_1 is 0. If LOCK prefix is used. Either the prefix REP (F3h) or REPN (F2H) is used.

#AC(0)

If alignment checking is enabled and an unaligned memory reference is made while the current privilege level is 3.

F2XM1—Compute 2^x-1

Opcode	Instruction	64-Bit Mode	Compat/Leg Mode	Description
D9 F0	F2XM1	Valid	Valid	Replace ST(0) with $(2^{\text{ST}(0)} - 1)$.

Description

Computes the exponential value of 2 to the power of the source operand minus 1. The source operand is located in register ST(0) and the result is also stored in ST(0). The value of the source operand must lie in the range -1.0 to $+1.0$. If the source value is outside this range, the result is undefined.

The following table shows the results obtained when computing the exponential value of various classes of numbers, assuming that neither overflow nor underflow occurs.

Table 3-29. Results Obtained from F2XM1

ST(0) SRC	ST(0) DEST
-1.0 to -0	-0.5 to -0
-0	-0
$+0$	$+0$
$+0$ to $+1.0$	$+0$ to 1.0

Values other than 2 can be exponentiated using the following formula:

$$x^y \leftarrow 2^{(y * \log_2 x)}$$

This instruction's operation is the same in non-64-bit modes and 64-bit mode.

Operation

$$\text{ST}(0) \leftarrow (2^{\text{ST}(0)} - 1);$$

FPU Flags Affected

C1	Set to 0 if stack underflow occurred. Set if result was rounded up; cleared otherwise.
C0, C2, C3	Undefined.

Floating-Point Exceptions

#IS	Stack underflow occurred.
#IA	Source operand is an SNaN value or unsupported format.
#D	Source is a denormal value.

#U	Result is too small for destination format.
#P	Value cannot be represented exactly in destination format.

Protected Mode Exceptions

#NM	CR0.EM[bit 2] or CR0.TS[bit 3] = 1.
#UD	If the LOCK prefix is used.

Real-Address Mode Exceptions

Same exceptions as in protected mode.

Virtual-8086 Mode Exceptions

Same exceptions as in protected mode.

Compatibility Mode Exceptions

Same exceptions as in protected mode.

64-Bit Mode Exceptions

Same exceptions as in protected mode.

FABS—Absolute Value

Opcode	Instruction	64-Bit Mode	Compat/ Leg Mode	Description
D9 E1	FABS	Valid	Valid	Replace ST with its absolute value.

Description

Clears the sign bit of ST(0) to create the absolute value of the operand. The following table shows the results obtained when creating the absolute value of various classes of numbers.

Table 3-30. Results Obtained from FABS

ST(0) SRC	ST(0) DEST
- •	+ •
- F	+ F
- 0	+ 0
+ 0	+ 0
+ F	+ F
+ •	+ •
NaN	NaN

NOTES:

F Means finite floating-point value.

This instruction's operation is the same in non-64-bit modes and 64-bit mode.

Operation

$ST(0) \leftarrow |ST(0)|;$

FPU Flags Affected

C1 Set to 0 if stack underflow occurred; otherwise, set to 0.
 C0, C2, C3 Undefined.

Floating-Point Exceptions

#IS Stack underflow occurred.

Protected Mode Exceptions

#NM CR0.EM[bit 2] or CR0.TS[bit 3] = 1.
 #UD If the LOCK prefix is used.

Real-Address Mode Exceptions

Same exceptions as in protected mode.

Virtual-8086 Mode Exceptions

Same exceptions as in protected mode.

Compatibility Mode Exceptions

Same exceptions as in protected mode.

64-Bit Mode Exceptions

Same exceptions as in protected mode.

FADD/FADDP/FIADD—Add

Opcode	Instruction	64-Bit Mode	Compat/ Leg Mode	Description
D8 /0	FADD <i>m32fp</i>	Valid	Valid	Add <i>m32fp</i> to ST(0) and store result in ST(0).
DC /0	FADD <i>m64fp</i>	Valid	Valid	Add <i>m64fp</i> to ST(0) and store result in ST(0).
D8 C0+i	FADD ST(0), ST(i)	Valid	Valid	Add ST(0) to ST(i) and store result in ST(0).
DC C0+i	FADD ST(i), ST(0)	Valid	Valid	Add ST(i) to ST(0) and store result in ST(i).
DE C0+i	FADDP ST(i), ST(0)	Valid	Valid	Add ST(0) to ST(i), store result in ST(i), and pop the register stack.
DE C1	FADDP	Valid	Valid	Add ST(0) to ST(1), store result in ST(1), and pop the register stack.
DA /0	FIADD <i>m32int</i>	Valid	Valid	Add <i>m32int</i> to ST(0) and store result in ST(0).
DE /0	FIADD <i>m16int</i>	Valid	Valid	Add <i>m16int</i> to ST(0) and store result in ST(0).

Description

Adds the destination and source operands and stores the sum in the destination location. The destination operand is always an FPU register; the source operand can be a register or a memory location. Source operands in memory can be in single-precision or double-precision floating-point format or in word or doubleword integer format.

The no-operand version of the instruction adds the contents of the ST(0) register to the ST(1) register. The one-operand version adds the contents of a memory location (either a floating-point or an integer value) to the contents of the ST(0) register. The two-operand version, adds the contents of the ST(0) register to the ST(i) register or vice versa. The value in ST(0) can be doubled by coding:

```
FADD ST(0), ST(0);
```

The FADDP instructions perform the additional operation of popping the FPU register stack after storing the result. To pop the register stack, the processor marks the ST(0) register as empty and increments the stack pointer (TOP) by 1. (The no-operand version of the floating-point add instructions always results in the register stack being popped. In some assemblers, the mnemonic for this instruction is FADD rather than FADDP.)

The FIADD instructions convert an integer source operand to double extended-precision floating-point format before performing the addition.

The table on the following page shows the results obtained when adding various classes of numbers, assuming that neither overflow nor underflow occurs.

When the sum of two operands with opposite signs is 0, the result is +0, except for the round toward $-\infty$ mode, in which case the result is -0 . When the source operand is an integer 0, it is treated as a +0.

When both operand are infinities of the same sign, the result is ∞ of the expected sign. If both operands are infinities of opposite signs, an invalid-operation exception is generated. See Table 3-31.

Table 3-31. FADD/FADDP/FIADD Results

		DEST						
		$-\infty$	$-F$	-0	$+0$	$+F$	$+\infty$	NaN
SRC	$-\infty$	$-\infty$	$-\infty$	$-\infty$	$-\infty$	$-\infty$	*	NaN
	$-F$ or $-I$	$-\infty$	$-F$	SRC	SRC	$\pm F$ or ± 0	$+\infty$	NaN
	-0	$-\infty$	DEST	-0	± 0	DEST	$+\infty$	NaN
	$+0$	$-\infty$	DEST	± 0	$+0$	DEST	$+\infty$	NaN
	$+F$ or $+I$	$-\infty$	$\pm F$ or ± 0	SRC	SRC	$+F$	$+\infty$	NaN
	$+\infty$	*	$+\infty$	$+\infty$	$+\infty$	$+\infty$	$+\infty$	NaN
	NaN	NaN	NaN	NaN	NaN	NaN	NaN	NaN

NOTES:

F Means finite floating-point value.

I Means integer.

* Indicates floating-point invalid-arithmetic-operand (#IA) exception.

This instruction's operation is the same in non-64-bit modes and 64-bit mode.

Operation

IF Instruction = FIADD

THEN

DEST \leftarrow DEST + ConvertToDoubleExtendedPrecisionFP(SRC);

ELSE (* Source operand is floating-point value *)

DEST \leftarrow DEST + SRC;

FI;

IF Instruction = FADDP

THEN

PopRegisterStack;

FI;

FPU Flags Affected

C1	Set to 0 if stack underflow occurred. Set if result was rounded up; cleared otherwise.
C0, C2, C3	Undefined.

Floating-Point Exceptions

#IS	Stack underflow occurred.
#IA	Operand is an SNaN value or unsupported format. Operands are infinities of unlike sign.
#D	Source operand is a denormal value.
#U	Result is too small for destination format.
#O	Result is too large for destination format.
#P	Value cannot be represented exactly in destination format.

Protected Mode Exceptions

#GP(0)	If a memory operand effective address is outside the CS, DS, ES, FS, or GS segment limit. If the DS, ES, FS, or GS register contains a NULL segment selector.
#SS(0)	If a memory operand effective address is outside the SS segment limit.
#NM	CR0.EM[bit 2] or CR0.TS[bit 3] = 1.
#PF(fault-code)	If a page fault occurs.
#AC(0)	If alignment checking is enabled and an unaligned memory reference is made while the current privilege level is 3.
#UD	If the LOCK prefix is used.

Real-Address Mode Exceptions

#GP	If a memory operand effective address is outside the CS, DS, ES, FS, or GS segment limit.
#SS	If a memory operand effective address is outside the SS segment limit.
#NM	CR0.EM[bit 2] or CR0.TS[bit 3] = 1.
#UD	If the LOCK prefix is used.

Virtual-8086 Mode Exceptions

#GP(0)	If a memory operand effective address is outside the CS, DS, ES, FS, or GS segment limit.
#SS(0)	If a memory operand effective address is outside the SS segment limit.

#NM	CR0.EM[bit 2] or CR0.TS[bit 3] = 1.
#PF(fault-code)	If a page fault occurs.
#AC(0)	If alignment checking is enabled and an unaligned memory reference is made.
#UD	If the LOCK prefix is used.

Compatibility Mode Exceptions

Same exceptions as in protected mode.

64-Bit Mode Exceptions

#SS(0)	If a memory address referencing the SS segment is in a non-canonical form.
#GP(0)	If the memory address is in a non-canonical form.
#NM	CR0.EM[bit 2] or CR0.TS[bit 3] = 1.
#MF	If there is a pending x87 FPU exception.
#PF(fault-code)	If a page fault occurs.
#AC(0)	If alignment checking is enabled and an unaligned memory reference is made while the current privilege level is 3.
#UD	If the LOCK prefix is used.

FBLD—Load Binary Coded Decimal

Opcode	Instruction	64-Bit Mode	Compat/ Leg Mode	Description
DF /4	FBLD <i>m80 dec</i>	Valid	Valid	Convert BCD value to floating-point and push onto the FPU stack.

Description

Converts the BCD source operand into double extended-precision floating-point format and pushes the value onto the FPU stack. The source operand is loaded without rounding errors. The sign of the source operand is preserved, including that of -0 .

The packed BCD digits are assumed to be in the range 0 through 9; the instruction does not check for invalid digits (AH through FH). Attempting to load an invalid encoding produces an undefined result.

This instruction's operation is the same in non-64-bit modes and 64-bit mode.

Operation

TOP \leftarrow TOP $- 1$;

ST(0) \leftarrow ConvertToDoubleExtendedPrecisionFP(SRC);

FPU Flags Affected

C1 Set to 1 if stack overflow occurred; otherwise, set to 0.
C0, C2, C3 Undefined.

Floating-Point Exceptions

#IS Stack overflow occurred.

Protected Mode Exceptions

#GP(0) If a memory operand effective address is outside the CS, DS, ES, FS, or GS segment limit.
If the DS, ES, FS, or GS register contains a NULL segment selector.

#SS(0) If a memory operand effective address is outside the SS segment limit.

#NM CR0.EM[bit 2] or CR0.TS[bit 3] = 1.

#PF(fault-code) If a page fault occurs.

#AC(0) If alignment checking is enabled and an unaligned memory reference is made while the current privilege level is 3.

#UD If the LOCK prefix is used.

Real-Address Mode Exceptions

#GP	If a memory operand effective address is outside the CS, DS, ES, FS, or GS segment limit.
#SS	If a memory operand effective address is outside the SS segment limit.
#NM	CR0.EM[bit 2] or CR0.TS[bit 3] = 1.
#UD	If the LOCK prefix is used.

Virtual-8086 Mode Exceptions

#GP(0)	If a memory operand effective address is outside the CS, DS, ES, FS, or GS segment limit.
#SS(0)	If a memory operand effective address is outside the SS segment limit.
#NM	CR0.EM[bit 2] or CR0.TS[bit 3] = 1.
#PF(fault-code)	If a page fault occurs.
#AC(0)	If alignment checking is enabled and an unaligned memory reference is made.
#UD	If the LOCK prefix is used.

Compatibility Mode Exceptions

Same exceptions as in protected mode.

64-Bit Mode Exceptions

#SS(0)	If a memory address referencing the SS segment is in a non-canonical form.
#GP(0)	If the memory address is in a non-canonical form.
#NM	CR0.EM[bit 2] or CR0.TS[bit 3] = 1.
#MF	If there is a pending x87 FPU exception.
#PF(fault-code)	If a page fault occurs.
#AC(0)	If alignment checking is enabled and an unaligned memory reference is made while the current privilege level is 3.
#UD	If the LOCK prefix is used.

FBSTP—Store BCD Integer and Pop

Opcode	Instruction	64-Bit Mode	Compat/ Leg Mode	Description
DF /6	FBSTP m80bcd	Valid	Valid	Store ST(0) in m80bcd and pop ST(0).

Description

Converts the value in the ST(0) register to an 18-digit packed BCD integer, stores the result in the destination operand, and pops the register stack. If the source value is a non-integral value, it is rounded to an integer value, according to rounding mode specified by the RC field of the FPU control word. To pop the register stack, the processor marks the ST(0) register as empty and increments the stack pointer (TOP) by 1.

The destination operand specifies the address where the first byte destination value is to be stored. The BCD value (including its sign bit) requires 10 bytes of space in memory.

The following table shows the results obtained when storing various classes of numbers in packed BCD format.

Table 3-32. FBSTP Results

ST(0)	DEST
-• or Value Too Large for DEST Format	*
$F \leq -1$	- D
$-1 < F < -0$	**
- 0	- 0
+ 0	+ 0
$+0 < F < +1$	**
$F \geq +1$	+ D
+• or Value Too Large for DEST Format	*
NaN	*

NOTES:

F Means finite floating-point value.

D Means packed-BCD number.

* Indicates floating-point invalid-operation (#IA) exception.

** ± 0 or ± 1 , depending on the rounding mode.

If the converted value is too large for the destination format, or if the source operand is an ∞ , SNaN, QNaN, or is in an unsupported format, an invalid-arithmic-operand condition is signaled. If the invalid-operation exception is not masked, an invalid-arithmic-operand exception (#IA) is generated and no value is stored in the desti-

nation operand. If the invalid-operation exception is masked, the packed BCD indefinite value is stored in memory.

This instruction's operation is the same in non-64-bit modes and 64-bit mode.

Operation

```
DEST ← BCD(ST(0));
PopRegisterStack;
```

FPU Flags Affected

C1	Set to 0 if stack underflow occurred. Set if result was rounded up; cleared otherwise.
C0, C2, C3	Undefined.

Floating-Point Exceptions

#IS	Stack underflow occurred.
#IA	Converted value that exceeds 18 BCD digits in length. Source operand is an SNaN, QNaN, $\pm\infty$, or in an unsupported format.
#P	Value cannot be represented exactly in destination format.

Protected Mode Exceptions

#GP(0)	If a segment register is being loaded with a segment selector that points to a non-writable segment. If a memory operand effective address is outside the CS, DS, ES, FS, or GS segment limit. If the DS, ES, FS, or GS register contains a NULL segment selector.
#SS(0)	If a memory operand effective address is outside the SS segment limit.
#NM	CR0.EM[bit 2] or CR0.TS[bit 3] = 1.
#PF(fault-code)	If a page fault occurs.
#AC(0)	If alignment checking is enabled and an unaligned memory reference is made while the current privilege level is 3.
#UD	If the LOCK prefix is used.

Real-Address Mode Exceptions

#GP	If a memory operand effective address is outside the CS, DS, ES, FS, or GS segment limit.
#SS	If a memory operand effective address is outside the SS segment limit.

#NM	CR0.EM[bit 2] or CR0.TS[bit 3] = 1.
#UD	If the LOCK prefix is used.

Virtual-8086 Mode Exceptions

#GP(0)	If a memory operand effective address is outside the CS, DS, ES, FS, or GS segment limit.
#SS(0)	If a memory operand effective address is outside the SS segment limit.
#NM	CR0.EM[bit 2] or CR0.TS[bit 3] = 1.
#PF(fault-code)	If a page fault occurs.
#AC(0)	If alignment checking is enabled and an unaligned memory reference is made.
#UD	If the LOCK prefix is used.

Compatibility Mode Exceptions

Same exceptions as in protected mode.

64-Bit Mode Exceptions

#SS(0)	If a memory address referencing the SS segment is in a non-canonical form.
#GP(0)	If the memory address is in a non-canonical form.
#NM	CR0.EM[bit 2] or CR0.TS[bit 3] = 1.
#MF	If there is a pending x87 FPU exception.
#PF(fault-code)	If a page fault occurs.
#AC(0)	If alignment checking is enabled and an unaligned memory reference is made while the current privilege level is 3.
#UD	If the LOCK prefix is used.

FCFS—Change Sign

Opcode	Instruction	64-Bit Mode	Compat/ Leg Mode	Description
D9 E0	FCFS	Valid	Valid	Complements sign of ST(0).

Description

Complements the sign bit of ST(0). This operation changes a positive value into a negative value of equal magnitude or vice versa. The following table shows the results obtained when changing the sign of various classes of numbers.

Table 3-33. FCFS Results

ST(0) SRC	ST(0) DEST
- •	+ •
- F	+ F
- 0	+ 0
+ 0	- 0
+ F	- F
+ •	- •
NaN	NaN

NOTES:

* F means finite floating-point value.

This instruction's operation is the same in non-64-bit modes and 64-bit mode.

Operation

SignBit(ST(0)) ← NOT (SignBit(ST(0)));

FPU Flags Affected

C1 Set to 0 if stack underflow occurred; otherwise, set to 0.
 C0, C2, C3 Undefined.

Floating-Point Exceptions

#IS Stack underflow occurred.

Protected Mode Exceptions

#NM CR0.EM[bit 2] or CR0.TS[bit 3] = 1.
 #UD If the LOCK prefix is used.

Real-Address Mode Exceptions

Same exceptions as in protected mode.

Virtual-8086 Mode Exceptions

Same exceptions as in protected mode.

Compatibility Mode Exceptions

Same exceptions as in protected mode.

64-Bit Mode Exceptions

Same exceptions as in protected mode.

FCLEX/FNCLEX—Clear Exceptions

Opcode*	Instruction	64-Bit Mode	Compat/Leg Mode	Description
9B DB E2	FCLEX	Valid	Valid	Clear floating-point exception flags after checking for pending unmasked floating-point exceptions.
DB E2	FNCLEX*	Valid	Valid	Clear floating-point exception flags without checking for pending unmasked floating-point exceptions.

NOTES:

* See IA-32 Architecture Compatibility section below.

Description

Clears the floating-point exception flags (PE, UE, OE, ZE, DE, and IE), the exception summary status flag (ES), the stack fault flag (SF), and the busy flag (B) in the FPU status word. The FCLEX instruction checks for and handles any pending unmasked floating-point exceptions before clearing the exception flags; the FNCLEX instruction does not.

The assembler issues two instructions for the FCLEX instruction (an FWAIT instruction followed by an FNCLEX instruction), and the processor executes each of these instructions separately. If an exception is generated for either of these instructions, the save EIP points to the instruction that caused the exception.

IA-32 Architecture Compatibility

When operating a Pentium or Intel486 processor in MS-DOS* compatibility mode, it is possible (under unusual circumstances) for an FNCLEX instruction to be interrupted prior to being executed to handle a pending FPU exception. See the section titled “No-Wait FPU Instructions Can Get FPU Interrupt in Window” in Appendix D of the *Intel® 64 and IA-32 Architectures Software Developer’s Manual, Volume 1*, for a description of these circumstances. An FNCLEX instruction cannot be interrupted in this way on a Pentium 4, Intel Xeon, or P6 family processor.

This instruction affects only the x87 FPU floating-point exception flags. It does not affect the SIMD floating-point exception flags in the MXCRS register.

This instruction’s operation is the same in non-64-bit modes and 64-bit mode.

Operation

FPUStatusWord[0:7] ← 0;

FPUStatusWord[15] ← 0;

FPU Flags Affected

The PE, UE, OE, ZE, DE, IE, ES, SF, and B flags in the FPU status word are cleared. The C0, C1, C2, and C3 flags are undefined.

Floating-Point Exceptions

None.

Protected Mode Exceptions

#NM CRO.EM[bit 2] or CRO.TS[bit 3] = 1.

#UD If the LOCK prefix is used.

Real-Address Mode Exceptions

Same exceptions as in protected mode.

Virtual-8086 Mode Exceptions

Same exceptions as in protected mode.

Compatibility Mode Exceptions

Same exceptions as in protected mode.

64-Bit Mode Exceptions

Same exceptions as in protected mode.

FCMOV_{cc}—Floating-Point Conditional Move

Opcode*	Instruction	64-Bit Mode	Compat/ Leg Mode*	Description
DA C0+i	FCMOVB ST(0), ST(i)	Valid	Valid	Move if below (CF=1).
DA C8+i	FCMOVE ST(0), ST(i)	Valid	Valid	Move if equal (ZF=1).
DA D0+i	FCMOVBE ST(0), ST(i)	Valid	Valid	Move if below or equal (CF=1 or ZF=1).
DA D8+i	FCMOVU ST(0), ST(i)	Valid	Valid	Move if unordered (PF=1).
DB C0+i	FCMOVNB ST(0), ST(i)	Valid	Valid	Move if not below (CF=0).
DB C8+i	FCMOVNE ST(0), ST(i)	Valid	Valid	Move if not equal (ZF=0).
DB D0+i	FCMOVNBE ST(0), ST(i)	Valid	Valid	Move if not below or equal (CF=0 and ZF=0).
DB D8+i	FCMOVNU ST(0), ST(i)	Valid	Valid	Move if not unordered (PF=0).

NOTES:

* See IA-32 Architecture Compatibility section below.

Description

Tests the status flags in the EFLAGS register and moves the source operand (second operand) to the destination operand (first operand) if the given test condition is true. The condition for each mnemonic is given in the Description column above and in Chapter 8 in the *Intel® 64 and IA-32 Architectures Software Developer's Manual, Volume 1*. The source operand is always in the ST(i) register and the destination operand is always ST(0).

The FCMOV_{cc} instructions are useful for optimizing small IF constructions. They also help eliminate branching overhead for IF operations and the possibility of branch mispredictions by the processor.

A processor may not support the FCMOV_{cc} instructions. Software can check if the FCMOV_{cc} instructions are supported by checking the processor's feature information with the CPUID instruction (see "COMISS—Compare Scalar Ordered Single-Precision Floating-Point Values and Set EFLAGS" in this chapter). If both the CMOV and FPU feature bits are set, the FCMOV_{cc} instructions are supported.

This instruction's operation is the same in non-64-bit modes and 64-bit mode.

IA-32 Architecture Compatibility

The FCMOV_{cc} instructions were introduced to the IA-32 Architecture in the P6 family processors and are not available in earlier IA-32 processors.

Operation

IF condition TRUE
THEN $ST(0) \leftarrow ST(i)$;
FI;

FPU Flags Affected

C1 Set to 0 if stack underflow occurred.
C0, C2, C3 Undefined.

Floating-Point Exceptions

#IS Stack underflow occurred.

Integer Flags Affected

None.

Protected Mode Exceptions

#NM CRO.EM[bit 2] or CRO.TS[bit 3] = 1.
#UD If the LOCK prefix is used.

Real-Address Mode Exceptions

Same exceptions as in protected mode.

Virtual-8086 Mode Exceptions

Same exceptions as in protected mode.

Compatibility Mode Exceptions

Same exceptions as in protected mode.

64-Bit Mode Exceptions

Same exceptions as in protected mode.

FCOM/FCOMP/FCOMPP—Compare Floating Point Values

Opcode	Instruction	64-Bit Mode	Compat/ Leg Mode	Description
D8 /2	FCOM <i>m32fp</i>	Valid	Valid	Compare ST(0) with <i>m32fp</i> .
DC /2	FCOM <i>m64fp</i>	Valid	Valid	Compare ST(0) with <i>m64fp</i> .
D8 D0+i	FCOM ST(i)	Valid	Valid	Compare ST(0) with ST(i).
D8 D1	FCOM	Valid	Valid	Compare ST(0) with ST(1).
D8 /3	FCOMP <i>m32fp</i>	Valid	Valid	Compare ST(0) with <i>m32fp</i> and pop register stack.
DC /3	FCOMP <i>m64fp</i>	Valid	Valid	Compare ST(0) with <i>m64fp</i> and pop register stack.
D8 D8+i	FCOMP ST(i)	Valid	Valid	Compare ST(0) with ST(i) and pop register stack.
D8 D9	FCOMP	Valid	Valid	Compare ST(0) with ST(1) and pop register stack.
DE D9	FCOMPP	Valid	Valid	Compare ST(0) with ST(1) and pop register stack twice.

Description

Compares the contents of register ST(0) and source value and sets condition code flags C0, C2, and C3 in the FPU status word according to the results (see the table below). The source operand can be a data register or a memory location. If no source operand is given, the value in ST(0) is compared with the value in ST(1). The sign of zero is ignored, so that -0.0 is equal to $+0.0$.

Table 3-34. FCOM/FCOMP/FCOMPP Results

Condition	C3	C2	C0
ST(0) > SRC	0	0	0
ST(0) < SRC	0	0	1
ST(0) = SRC	1	0	0
Unordered*	1	1	1

NOTES:

* Flags not set if unmasked invalid-arithmetic-operand (#IA) exception is generated.

This instruction checks the class of the numbers being compared (see “FXAM—Examine ModR/M” in this chapter). If either operand is a NaN or is in an unsupported format, an invalid-arithmetic-operand exception (#IA) is raised and, if the exception is masked, the condition flags are set to “unordered.” If the invalid-arithmetic-operand exception is unmasked, the condition code flags are not set.

The FCOMP instruction pops the register stack following the comparison operation and the FCOMPP instruction pops the register stack twice following the comparison operation. To pop the register stack, the processor marks the ST(0) register as empty and increments the stack pointer (TOP) by 1.

The FCOM instructions perform the same operation as the FUCOM instructions. The only difference is how they handle QNaN operands. The FCOM instructions raise an invalid-arithmetic-operand exception (#IA) when either or both of the operands is a NaN value or is in an unsupported format. The FUCOM instructions perform the same operation as the FCOM instructions, except that they do not generate an invalid-arithmetic-operand exception for QNaNs.

This instruction's operation is the same in non-64-bit modes and 64-bit mode.

Operation

CASE (relation of operands) OF

ST > SRC: C3, C2, C0 ← 000;

ST < SRC: C3, C2, C0 ← 001;

ST = SRC: C3, C2, C0 ← 100;

ESAC;

IF ST(0) or SRC = NaN or unsupported format

THEN

#IA

IF FPUControlWord.IM = 1

THEN

C3, C2, C0 ← 111;

FI;

FI;

IF Instruction = FCOMP

THEN

PopRegisterStack;

FI;

IF Instruction = FCOMPP

THEN

PopRegisterStack;

PopRegisterStack;

FI;

FPU Flags Affected

C1 Set to 0 if stack underflow occurred; otherwise, set to 0.

C0, C2, C3 See table on previous page.

Floating-Point Exceptions

#IS	Stack underflow occurred.
#IA	One or both operands are NaN values or have unsupported formats.
	Register is marked empty.
#D	One or both operands are denormal values.

Protected Mode Exceptions

#GP(0)	If a memory operand effective address is outside the CS, DS, ES, FS, or GS segment limit. If the DS, ES, FS, or GS register contains a NULL segment selector.
#SS(0)	If a memory operand effective address is outside the SS segment limit.
#NM	CR0.EM[bit 2] or CR0.TS[bit 3] = 1.
#PF(fault-code)	If a page fault occurs.
#AC(0)	If alignment checking is enabled and an unaligned memory reference is made while the current privilege level is 3.
#UD	If the LOCK prefix is used.

Real-Address Mode Exceptions

#GP	If a memory operand effective address is outside the CS, DS, ES, FS, or GS segment limit.
#SS	If a memory operand effective address is outside the SS segment limit.
#NM	CR0.EM[bit 2] or CR0.TS[bit 3] = 1.
#UD	If the LOCK prefix is used.

Virtual-8086 Mode Exceptions

#GP(0)	If a memory operand effective address is outside the CS, DS, ES, FS, or GS segment limit.
#SS(0)	If a memory operand effective address is outside the SS segment limit.
#NM	CR0.EM[bit 2] or CR0.TS[bit 3] = 1.
#PF(fault-code)	If a page fault occurs.
#AC(0)	If alignment checking is enabled and an unaligned memory reference is made.
#UD	If the LOCK prefix is used.

Compatibility Mode Exceptions

Same exceptions as in protected mode.

64-Bit Mode Exceptions

#SS(0)	If a memory address referencing the SS segment is in a non-canonical form.
#GP(0)	If the memory address is in a non-canonical form.
#NM	CR0.EM[bit 2] or CR0.TS[bit 3] = 1.
#MF	If there is a pending x87 FPU exception.
#PF(fault-code)	If a page fault occurs.
#AC(0)	If alignment checking is enabled and an unaligned memory reference is made while the current privilege level is 3.
#UD	If the LOCK prefix is used.

FCOMI/FCOMIP/FUCOMI/FUCOMIP—Compare Floating Point Values and Set EFLAGS

Opcode	Instruction	64-Bit Mode	Compat/Leg Mode	Description
DB F0+i	FCOMI ST, ST(i)	Valid	Valid	Compare ST(0) with ST(i) and set status flags accordingly.
DF F0+i	FCOMIP ST, ST(i)	Valid	Valid	Compare ST(0) with ST(i), set status flags accordingly, and pop register stack.
DB E8+i	FUCOMI ST, ST(i)	Valid	Valid	Compare ST(0) with ST(i), check for ordered values, and set status flags accordingly.
DF E8+i	FUCOMIP ST, ST(i)	Valid	Valid	Compare ST(0) with ST(i), check for ordered values, set status flags accordingly, and pop register stack.

Description

Performs an unordered comparison of the contents of registers ST(0) and ST(i) and sets the status flags ZF, PF, and CF in the EFLAGS register according to the results (see the table below). The sign of zero is ignored for comparisons, so that -0.0 is equal to $+0.0$.

Table 3-35. FCOMI/FCOMIP/ FUCOMI/FUCOMIP Results

Comparison Results*	ZF	PF	CF
ST0 > ST(i)	0	0	0
ST0 < ST(i)	0	0	1
ST0 = ST(i)	1	0	0
Unordered**	1	1	1

NOTES:

* See the IA-32 Architecture Compatibility section below.

** Flags not set if unmasked invalid-arithmetic-operand (#IA) exception is generated.

An unordered comparison checks the class of the numbers being compared (see “FXAM—Examine ModR/M” in this chapter). The FUCOMI/FUCOMIP instructions perform the same operations as the FCOMI/FCOMIP instructions. The only difference is that the FUCOMI/FUCOMIP instructions raise the invalid-arithmetic-operand exception (#IA) only when either or both operands are an SNaN or are in an unsupported format; QNaNs cause the condition code flags to be set to unordered, but do not cause an exception to be generated. The FCOMI/FCOMIP instructions raise an invalid-operation exception when either or both of the operands are a NaN value of any kind or are in an unsupported format.

If the operation results in an invalid-arithmetic-operand exception being raised, the status flags in the EFLAGS register are set only if the exception is masked.

The FCOMI/FCOMIP and FUCOMI/FUCOMIP instructions clear the OF flag in the EFLAGS register (regardless of whether an invalid-operation exception is detected).

The FCOMIP and FUCOMIP instructions also pop the register stack following the comparison operation. To pop the register stack, the processor marks the ST(0) register as empty and increments the stack pointer (TOP) by 1.

This instruction's operation is the same in non-64-bit modes and 64-bit mode.

IA-32 Architecture Compatibility

The FCOMI/FCOMIP/FUCOMI/FUCOMIP instructions were introduced to the IA-32 Architecture in the P6 family processors and are not available in earlier IA-32 processors.

Operation

CASE (relation of operands) OF

ST(0) > ST(i): ZF, PF, CF ← 000;

ST(0) < ST(i): ZF, PF, CF ← 001;

ST(0) = ST(i): ZF, PF, CF ← 100;

ESAC;

IF Instruction is FCOMI or FCOMIP

THEN

IF ST(0) or ST(i) = NaN or unsupported format

THEN

#IA

IF FPUControlWord.IM = 1

THEN

ZF, PF, CF ← 111;

FI;

FI;

FI;

IF Instruction is FUCOMI or FUCOMIP

THEN

IF ST(0) or ST(i) = QNaN, but not SNaN or unsupported format

THEN

ZF, PF, CF ← 111;

ELSE (* ST(0) or ST(i) is SNaN or unsupported format *)

#IA;

IF FPUControlWord.IM = 1

THEN

```

ZF, PF, CF ← 111;
    FI;
FI;
IF Instruction is FCOMIP or FUCOMIP
    THEN
        PopRegisterStack;
FI;

```

FPU Flags Affected

C1 Set to 0 if stack underflow occurred; otherwise, set to 0.
C0, C2, C3 Not affected.

Floating-Point Exceptions

#IS Stack underflow occurred.
#IA (FCOMI or FCOMIP instruction) One or both operands are NaN values or have unsupported formats.
(FUCOMI or FUCOMIP instruction) One or both operands are SNaN values (but not QNaNs) or have undefined formats.
Detection of a QNaN value does not raise an invalid-operand exception.

Protected Mode Exceptions

#NM CR0.EM[bit 2] or CR0.TS[bit 3] = 1.
#MF If there is a pending x87 FPU exception.
#UD If the LOCK prefix is used.

Real-Address Mode Exceptions

Same exceptions as in protected mode.

Virtual-8086 Mode Exceptions

Same exceptions as in protected mode.

Compatibility Mode Exceptions

Same exceptions as in protected mode.

64-Bit Mode Exceptions

Same exceptions as in protected mode.

FCOS—Cosine

Opcode	Instruction	64-Bit Mode	Compat/ Leg Mode	Description
D9 FF	FCOS	Valid	Valid	Replace ST(0) with its cosine.

Description

Computes the cosine of the source operand in register ST(0) and stores the result in ST(0). The source operand must be given in radians and must be within the range -2^{63} to $+2^{63}$. The following table shows the results obtained when taking the cosine of various classes of numbers.

Table 3-36. FCOS Results

ST(0) SRC	ST(0) DEST
- •	*
- F	-1 to +1
- 0	+ 1
+ 0	+ 1
+ F	- 1 to + 1
+ •	*
NaN	NaN

NOTES:

F Means finite floating-point value.

* Indicates floating-point invalid-arithmetic-operand (#IA) exception.

If the source operand is outside the acceptable range, the C2 flag in the FPU status word is set, and the value in register ST(0) remains unchanged. The instruction does not raise an exception when the source operand is out of range. It is up to the program to check the C2 flag for out-of-range conditions. Source values outside the range -2^{63} to $+2^{63}$ can be reduced to the range of the instruction by subtracting an appropriate integer multiple of 2π or by using the FPREM instruction with a divisor of 2π . See the section titled "Pi" in Chapter 8 of the *Intel® 64 and IA-32 Architectures Software Developer's Manual, Volume 1*, for a discussion of the proper value to use for π in performing such reductions.

This instruction's operation is the same in non-64-bit modes and 64-bit mode.

Operation

```
IF |ST(0)| < 263
THEN
  C2 ← 0;
```

```

ST(0) ← cosine(ST(0));
ELSE (* Source operand is out-of-range *)
    C2 ← 1;
FI;

```

FPU Flags Affected

C1	Set to 0 if stack underflow occurred. Set if result was rounded up; cleared otherwise. Undefined if C2 is 1.
C2	Set to 1 if outside range ($-2^{63} < \text{source operand} < +2^{63}$); otherwise, set to 0.
C0, C3	Undefined.

Floating-Point Exceptions

#IS	Stack underflow occurred.
#IA	Source operand is an SNaN value, ∞ , or unsupported format.
#D	Source is a denormal value.
#P	Value cannot be represented exactly in destination format.

Protected Mode Exceptions

#NM	CR0.EM[bit 2] or CR0.TS[bit 3] = 1.
#MF	If there is a pending x87 FPU exception.
#UD	If the LOCK prefix is used.

Real-Address Mode Exceptions

Same exceptions as in protected mode.

Virtual-8086 Mode Exceptions

Same exceptions as in protected mode.

Compatibility Mode Exceptions

Same exceptions as in protected mode.

64-Bit Mode Exceptions

Same exceptions as in protected mode.

FDECSTP—Decrement Stack-Top Pointer

Opcode	Instruction	64-Bit Mode	Compat/ Leg Mode	Description
D9 F6	FDECSTP	Valid	Valid	Decrement TOP field in FPU status word.

Description

Subtracts one from the TOP field of the FPU status word (decrements the top-of-stack pointer). If the TOP field contains a 0, it is set to 7. The effect of this instruction is to rotate the stack by one position. The contents of the FPU data registers and tag register are not affected.

This instruction's operation is the same in non-64-bit modes and 64-bit mode.

Operation

```
IF TOP = 0
  THEN TOP ← 7;
  ELSE TOP ← TOP - 1;
FI;
```

FPU Flags Affected

The C1 flag is set to 0. The C0, C2, and C3 flags are undefined.

Floating-Point Exceptions

None.

Protected Mode Exceptions

#NM CR0.EM[bit 2] or CR0.TS[bit 3] = 1.
 #MF If there is a pending x87 FPU exception.
 #UD If the LOCK prefix is used.

Real-Address Mode Exceptions

Same exceptions as in protected mode.

Virtual-8086 Mode Exceptions

Same exceptions as in protected mode.

Compatibility Mode Exceptions

Same exceptions as in protected mode.

64-Bit Mode Exceptions

Same exceptions as in protected mode.

FDIV/FDIVP/FIDIV—Divide

Opcode	Instruction	64-Bit Mode	Compat/ Leg Mode	Description
D8 /6	FDIV <i>m32fp</i>	Valid	Valid	Divide ST(0) by <i>m32fp</i> and store result in ST(0).
DC /6	FDIV <i>m64fp</i>	Valid	Valid	Divide ST(0) by <i>m64fp</i> and store result in ST(0).
D8 F0+i	FDIV ST(0), ST(i)	Valid	Valid	Divide ST(0) by ST(i) and store result in ST(0).
DC F8+i	FDIV ST(i), ST(0)	Valid	Valid	Divide ST(i) by ST(0) and store result in ST(i).
DE F8+i	FDIVP ST(i), ST(0)	Valid	Valid	Divide ST(i) by ST(0), store result in ST(i), and pop the register stack.
DE F9	FDIVP	Valid	Valid	Divide ST(1) by ST(0), store result in ST(1), and pop the register stack.
DA /6	FIDIV <i>m32int</i>	Valid	Valid	Divide ST(0) by <i>m32int</i> and store result in ST(0).
DE /6	FIDIV <i>m64int</i>	Valid	Valid	Divide ST(0) by <i>m64int</i> and store result in ST(0).

Description

Divides the destination operand by the source operand and stores the result in the destination location. The destination operand (dividend) is always in an FPU register; the source operand (divisor) can be a register or a memory location. Source operands in memory can be in single-precision or double-precision floating-point format, word or doubleword integer format.

The no-operand version of the instruction divides the contents of the ST(1) register by the contents of the ST(0) register. The one-operand version divides the contents of the ST(0) register by the contents of a memory location (either a floating-point or an integer value). The two-operand version, divides the contents of the ST(0) register by the contents of the ST(i) register or vice versa.

The FDIVP instructions perform the additional operation of popping the FPU register stack after storing the result. To pop the register stack, the processor marks the ST(0) register as empty and increments the stack pointer (TOP) by 1. The no-operand version of the floating-point divide instructions always results in the register stack being popped. In some assemblers, the mnemonic for this instruction is FDIV rather than FDIVP.

The FIDIV instructions convert an integer source operand to double extended-precision floating-point format before performing the division. When the source operand is an integer 0, it is treated as a +0.

If an unmasked divide-by-zero exception (**#Z**) is generated, no result is stored; if the exception is masked, an ∞ of the appropriate sign is stored in the destination operand.

The following table shows the results obtained when dividing various classes of numbers, assuming that neither overflow nor underflow occurs.

Table 3-37. FDIV/FDIVP/FIDIV Results

		DEST						
		-•	-F	-0	+0	+F	+•	
SRC	-•	*	+0	+0	-0	-0	*	NaN
	-F	+•	+F	+0	-0	-F	-•	NaN
	-I	+•	+F	+0	-0	-F	-•	NaN
	-0	+•	**	*	*	**	-•	NaN
	+0	-•	**	*	*	**	+•	NaN
	+I	-•	-F	-0	+0	+F	+•	NaN
	+F	-•	-F	-0	+0	+F	+•	NaN
	+•	*	-0	-0	+0	+0	*	NaN
	NaN	NaN	NaN	NaN	NaN	NaN	NaN	NaN

NOTES:

F Means finite floating-point value.

I Means integer.

* Indicates floating-point invalid-arithmic-operand (**#IA**) exception.

** Indicates floating-point zero-divide (**#Z**) exception.

This instruction's operation is the same in non-64-bit modes and 64-bit mode.

Operation

IF SRC = 0

THEN

#Z;

ELSE

IF Instruction is FIDIV

THEN

DEST ← DEST / ConvertToDoubleExtendedPrecisionFP(SRC);

ELSE (* Source operand is floating-point value *)

DEST ← DEST / SRC;

FI;

FI;

```
IF Instruction = FDIVP
    THEN
        PopRegisterStack;
FI;
```

FPU Flags Affected

C1 Set to 0 if stack underflow occurred.
 Set if result was rounded up; cleared otherwise.

C0, C2, C3 Undefined.

Floating-Point Exceptions

#IS Stack underflow occurred.

#IA Operand is an SNaN value or unsupported format.
 $\pm\infty / \pm\infty$; $\pm 0 / \pm 0$

#D Source is a denormal value.

#Z DEST / ± 0 , where DEST is not equal to ± 0 .

#U Result is too small for destination format.

#O Result is too large for destination format.

#P Value cannot be represented exactly in destination format.

Protected Mode Exceptions

#GP(0) If a memory operand effective address is outside the CS, DS, ES, FS, or GS segment limit.
 If the DS, ES, FS, or GS register contains a NULL segment selector.

#SS(0) If a memory operand effective address is outside the SS segment limit.

#NM CR0.EM[bit 2] or CR0.TS[bit 3] = 1.

#PF(fault-code) If a page fault occurs.

#AC(0) If alignment checking is enabled and an unaligned memory reference is made while the current privilege level is 3.

#UD If the LOCK prefix is used.

Real-Address Mode Exceptions

#GP If a memory operand effective address is outside the CS, DS, ES, FS, or GS segment limit.

#SS If a memory operand effective address is outside the SS segment limit.

#NM CR0.EM[bit 2] or CR0.TS[bit 3] = 1.

#UD If the LOCK prefix is used.

Virtual-8086 Mode Exceptions

#GP(0)	If a memory operand effective address is outside the CS, DS, ES, FS, or GS segment limit.
#SS(0)	If a memory operand effective address is outside the SS segment limit.
#NM	CR0.EM[bit 2] or CR0.TS[bit 3] = 1.
#PF(fault-code)	If a page fault occurs.
#AC(0)	If alignment checking is enabled and an unaligned memory reference is made.
#UD	If the LOCK prefix is used.

Compatibility Mode Exceptions

Same exceptions as in protected mode.

64-Bit Mode Exceptions

#SS(0)	If a memory address referencing the SS segment is in a non-canonical form.
#GP(0)	If the memory address is in a non-canonical form.
#NM	CR0.EM[bit 2] or CR0.TS[bit 3] = 1.
#MF	If there is a pending x87 FPU exception.
#PF(fault-code)	If a page fault occurs.
#AC(0)	If alignment checking is enabled and an unaligned memory reference is made while the current privilege level is 3.
#UD	If the LOCK prefix is used.

FDIVR/FDIVRP/FIDIVR—Reverse Divide

Opcode	Instruction	64-Bit Mode	Compat/Leg Mode	Description
D8 /7	FDIVR <i>m32fp</i>	Valid	Valid	Divide <i>m32fp</i> by ST(0) and store result in ST(0).
DC /7	FDIVR <i>m64fp</i>	Valid	Valid	Divide <i>m64fp</i> by ST(0) and store result in ST(0).
D8 F8+i	FDIVR ST(0), ST(i)	Valid	Valid	Divide ST(i) by ST(0) and store result in ST(0).
DC F0+i	FDIVR ST(i), ST(0)	Valid	Valid	Divide ST(0) by ST(i) and store result in ST(i).
DE F0+i	FDIVRP ST(i), ST(0)	Valid	Valid	Divide ST(0) by ST(i), store result in ST(i), and pop the register stack.
DE F1	FDIVRP	Valid	Valid	Divide ST(0) by ST(1), store result in ST(1), and pop the register stack.
DA /7	FIDIVR <i>m32int</i>	Valid	Valid	Divide <i>m32int</i> by ST(0) and store result in ST(0).
DE /7	FIDIVR <i>m16int</i>	Valid	Valid	Divide <i>m16int</i> by ST(0) and store result in ST(0).

Description

Divides the source operand by the destination operand and stores the result in the destination location. The destination operand (divisor) is always in an FPU register; the source operand (dividend) can be a register or a memory location. Source operands in memory can be in single-precision or double-precision floating-point format, word or doubleword integer format.

These instructions perform the reverse operations of the FDIV, FDIVP, and FIDIV instructions. They are provided to support more efficient coding.

The no-operand version of the instruction divides the contents of the ST(0) register by the contents of the ST(1) register. The one-operand version divides the contents of a memory location (either a floating-point or an integer value) by the contents of the ST(0) register. The two-operand version, divides the contents of the ST(i) register by the contents of the ST(0) register or vice versa.

The FDIVRP instructions perform the additional operation of popping the FPU register stack after storing the result. To pop the register stack, the processor marks the ST(0) register as empty and increments the stack pointer (TOP) by 1. The no-operand version of the floating-point divide instructions always results in the register stack being popped. In some assemblers, the mnemonic for this instruction is FDIVR rather than FDIVRP.

The FIDIVR instructions convert an integer source operand to double extended-precision floating-point format before performing the division.

If an unmasked divide-by-zero exception (**#Z**) is generated, no result is stored; if the exception is masked, an ∞ of the appropriate sign is stored in the destination operand.

The following table shows the results obtained when dividing various classes of numbers, assuming that neither overflow nor underflow occurs.

Table 3-38. FDIVR/FDIVRP/FIDIVR Results

		DEST						
		-•	- F	- 0	+ 0	+ F	+•	
SRC	-•	*	+•	+•	-•	-•	*	NaN
	- F	+ 0	+ F	**	**	- F	- 0	NaN
	- I	+ 0	+ F	**	**	- F	- 0	NaN
	- 0	+ 0	+ 0	*	*	- 0	- 0	NaN
	+ 0	- 0	- 0	*	*	+ 0	+ 0	NaN
	+ I	- 0	- F	**	**	+ F	+ 0	NaN
	+ F	- 0	- F	**	**	+ F	+ 0	NaN
	+•	*	-•	-•	+•	+•	*	NaN
	NaN	NaN	NaN	NaN	NaN	NaN	NaN	NaN

NOTES:

F Means finite floating-point value.

I Means integer.

* Indicates floating-point invalid-arithmetic-operand (**#IA**) exception.

** Indicates floating-point zero-divide (**#Z**) exception.

When the source operand is an integer 0, it is treated as a +0. This instruction's operation is the same in non-64-bit modes and 64-bit mode.

Operation

IF DEST = 0

THEN

#Z;

ELSE

IF Instruction = FIDIVR

THEN

DEST ← ConvertToDoubleExtendedPrecisionFP(SRC) / DEST;

ELSE (* Source operand is floating-point value *)

```

                DEST ← SRC / DEST;
    FI;
FI;
IF Instruction = FDIVRP
    THEN
        PopRegisterStack;
FI;

```

FPU Flags Affected

C1 Set to 0 if stack underflow occurred.
 Set if result was rounded up; cleared otherwise.

C0, C2, C3 Undefined.

Floating-Point Exceptions

#IS Stack underflow occurred.

#IA Operand is an SNaN value or unsupported format.
 $\pm\infty / \pm\infty$; $\pm 0 / \pm 0$

#D Source is a denormal value.

#Z $SRC / \pm 0$, where SRC is not equal to ± 0 .

#U Result is too small for destination format.

#O Result is too large for destination format.

#P Value cannot be represented exactly in destination format.

Protected Mode Exceptions

#GP(0) If a memory operand effective address is outside the CS, DS, ES, FS, or GS segment limit.
 If the DS, ES, FS, or GS register contains a NULL segment selector.

#SS(0) If a memory operand effective address is outside the SS segment limit.

#NM CR0.EM[bit 2] or CR0.TS[bit 3] = 1.

#PF(fault-code) If a page fault occurs.

#AC(0) If alignment checking is enabled and an unaligned memory reference is made while the current privilege level is 3.

#UD If the LOCK prefix is used.

Real-Address Mode Exceptions

#GP If a memory operand effective address is outside the CS, DS, ES, FS, or GS segment limit.

#SS	If a memory operand effective address is outside the SS segment limit.
#NM	CR0.EM[bit 2] or CR0.TS[bit 3] = 1.
#UD	If the LOCK prefix is used.

Virtual-8086 Mode Exceptions

#GP(0)	If a memory operand effective address is outside the CS, DS, ES, FS, or GS segment limit.
#SS(0)	If a memory operand effective address is outside the SS segment limit.
#NM	CR0.EM[bit 2] or CR0.TS[bit 3] = 1.
#PF(fault-code)	If a page fault occurs.
#AC(0)	If alignment checking is enabled and an unaligned memory reference is made.
#UD	If the LOCK prefix is used.

Compatibility Mode Exceptions

Same exceptions as in protected mode.

64-Bit Mode Exceptions

#SS(0)	If a memory address referencing the SS segment is in a non-canonical form.
#GP(0)	If the memory address is in a non-canonical form.
#NM	CR0.EM[bit 2] or CR0.TS[bit 3] = 1.
#MF	If there is a pending x87 FPU exception.
#PF(fault-code)	If a page fault occurs.
#AC(0)	If alignment checking is enabled and an unaligned memory reference is made while the current privilege level is 3.
#UD	If the LOCK prefix is used.

FFREE—Free Floating-Point Register

Opcode	Instruction	64-Bit Mode	Compat/Leg Mode	Description
DD C0+i	FFREE ST(i)	Valid	Valid	Sets tag for ST(i) to empty.

Description

Sets the tag in the FPU tag register associated with register ST(i) to empty (11B). The contents of ST(i) and the FPU stack-top pointer (TOP) are not affected.

This instruction's operation is the same in non-64-bit modes and 64-bit mode.

Operation

TAG(i) ← 11B;

FPU Flags Affected

C0, C1, C2, C3 undefined.

Floating-Point Exceptions

None.

Protected Mode Exceptions

- #NM CRO.EM[bit 2] or CRO.TS[bit 3] = 1.
- #MF If there is a pending x87 FPU exception.
- #UD If the LOCK prefix is used.

Real-Address Mode Exceptions

Same exceptions as in protected mode.

Virtual-8086 Mode Exceptions

Same exceptions as in protected mode.

Compatibility Mode Exceptions

Same exceptions as in protected mode.

64-Bit Mode Exceptions

Same exceptions as in protected mode.

FICOM/FICOMP—Compare Integer

Opcode	Instruction	64-Bit Mode	Compat/ Leg Mode	Description
DE /2	FICOM <i>m16int</i>	Valid	Valid	Compare ST(0) with <i>m16int</i> .
DA /2	FICOM <i>m32int</i>	Valid	Valid	Compare ST(0) with <i>m32int</i> .
DE /3	FICOMP <i>m16int</i>	Valid	Valid	Compare ST(0) with <i>m16int</i> and pop stack register.
DA /3	FICOMP <i>m32int</i>	Valid	Valid	Compare ST(0) with <i>m32int</i> and pop stack register.

Description

Compares the value in ST(0) with an integer source operand and sets the condition code flags C0, C2, and C3 in the FPU status word according to the results (see table below). The integer value is converted to double extended-precision floating-point format before the comparison is made.

Table 3-39. FICOM/FICOMP Results

Condition	C3	C2	C0
ST(0) > SRC	0	0	0
ST(0) < SRC	0	0	1
ST(0) = SRC	1	0	0
Unordered	1	1	1

These instructions perform an “unordered comparison.” An unordered comparison also checks the class of the numbers being compared (see “FXAM—Examine ModR/M” in this chapter). If either operand is a NaN or is in an undefined format, the condition flags are set to “unordered.”

The sign of zero is ignored, so that $-0.0 \leftarrow +0.0$.

The FICOMP instructions pop the register stack following the comparison. To pop the register stack, the processor marks the ST(0) register empty and increments the stack pointer (TOP) by 1.

This instruction’s operation is the same in non-64-bit modes and 64-bit mode.

Operation

CASE (relation of operands) OF

ST(0) > SRC: C3, C2, C0 ← 000;
 ST(0) < SRC: C3, C2, C0 ← 001;
 ST(0) = SRC: C3, C2, C0 ← 100;
 Unordered: C3, C2, C0 ← 111;

ESAC;

```
IF Instruction = FICOMP
    THEN
        PopRegisterStack;
FI;
```

FPU Flags Affected

C1 Set to 0 if stack underflow occurred; otherwise, set to 0.
 C0, C2, C3 See table on previous page.

Floating-Point Exceptions

#IS Stack underflow occurred.
 #IA One or both operands are NaN values or have unsupported formats.
 #D One or both operands are denormal values.

Protected Mode Exceptions

#GP(0) If a memory operand effective address is outside the CS, DS, ES, FS, or GS segment limit.
 If the DS, ES, FS, or GS register contains a NULL segment selector.
 #SS(0) If a memory operand effective address is outside the SS segment limit.
 #NM CR0.EM[bit 2] or CR0.TS[bit 3] = 1.
 #PF(fault-code) If a page fault occurs.
 #AC(0) If alignment checking is enabled and an unaligned memory reference is made while the current privilege level is 3.
 #UD If the LOCK prefix is used.

Real-Address Mode Exceptions

#GP If a memory operand effective address is outside the CS, DS, ES, FS, or GS segment limit.
 #SS If a memory operand effective address is outside the SS segment limit.
 #NM CR0.EM[bit 2] or CR0.TS[bit 3] = 1.
 #UD If the LOCK prefix is used.

Virtual-8086 Mode Exceptions

#GP(0) If a memory operand effective address is outside the CS, DS, ES, FS, or GS segment limit.

#SS(0)	If a memory operand effective address is outside the SS segment limit.
#NM	CR0.EM[bit 2] or CR0.TS[bit 3] = 1.
#PF(fault-code)	If a page fault occurs.
#AC(0)	If alignment checking is enabled and an unaligned memory reference is made.
#UD	If the LOCK prefix is used.

Compatibility Mode Exceptions

Same exceptions as in protected mode.

64-Bit Mode Exceptions

#SS(0)	If a memory address referencing the SS segment is in a non-canonical form.
#GP(0)	If the memory address is in a non-canonical form.
#NM	CR0.EM[bit 2] or CR0.TS[bit 3] = 1.
#MF	If there is a pending x87 FPU exception.
#PF(fault-code)	If a page fault occurs.
#AC(0)	If alignment checking is enabled and an unaligned memory reference is made while the current privilege level is 3.
#UD	If the LOCK prefix is used.

FILD—Load Integer

Opcode	Instruction	64-Bit Mode	Compat/Leg Mode	Description
DF /0	FILD <i>m16int</i>	Valid	Valid	Push <i>m16int</i> onto the FPU register stack.
DB /0	FILD <i>m32int</i>	Valid	Valid	Push <i>m32int</i> onto the FPU register stack.
DF /5	FILD <i>m64int</i>	Valid	Valid	Push <i>m64int</i> onto the FPU register stack.

Description

Converts the signed-integer source operand into double extended-precision floating-point format and pushes the value onto the FPU register stack. The source operand can be a word, doubleword, or quadword integer. It is loaded without rounding errors. The sign of the source operand is preserved.

This instruction's operation is the same in non-64-bit modes and 64-bit mode.

Operation

TOP ← TOP – 1;
ST(0) ← ConvertToDoubleExtendedPrecisionFP(SRC);

FPU Flags Affected

C1 Set to 1 if stack overflow occurred; set to 0 otherwise.
C0, C2, C3 Undefined.

Floating-Point Exceptions

#IS Stack overflow occurred.

Protected Mode Exceptions

#GP(0) If a memory operand effective address is outside the CS, DS, ES, FS, or GS segment limit.
 If the DS, ES, FS, or GS register contains a NULL segment selector.

#SS(0) If a memory operand effective address is outside the SS segment limit.

#NM CRO.EM[bit 2] or CRO.TS[bit 3] = 1.

#PF(fault-code) If a page fault occurs.

#AC(0) If alignment checking is enabled and an unaligned memory reference is made while the current privilege level is 3.

#UD If the LOCK prefix is used.

Real-Address Mode Exceptions

#GP If a memory operand effective address is outside the CS, DS, ES, FS, or GS segment limit.

#SS If a memory operand effective address is outside the SS segment limit.

#NM CR0.EM[bit 2] or CR0.TS[bit 3] = 1.

#UD If the LOCK prefix is used.

Virtual-8086 Mode Exceptions

#GP(0) If a memory operand effective address is outside the CS, DS, ES, FS, or GS segment limit.

#SS(0) If a memory operand effective address is outside the SS segment limit.

#NM CR0.EM[bit 2] or CR0.TS[bit 3] = 1.

#PF(fault-code) If a page fault occurs.

#AC(0) If alignment checking is enabled and an unaligned memory reference is made.

#UD If the LOCK prefix is used.

Compatibility Mode Exceptions

Same exceptions as in protected mode.

64-Bit Mode Exceptions

#SS(0) If a memory address referencing the SS segment is in a non-canonical form.

#GP(0) If the memory address is in a non-canonical form.

#NM CR0.EM[bit 2] or CR0.TS[bit 3] = 1.

#MF If there is a pending x87 FPU exception.

#PF(fault-code) If a page fault occurs.

#AC(0) If alignment checking is enabled and an unaligned memory reference is made while the current privilege level is 3.

#UD If the LOCK prefix is used.

FINCSTP—Increment Stack-Top Pointer

Opcode	Instruction	64-Bit Mode	Compat/ Leg Mode	Description
D9 F7	FINCSTP	Valid	Valid	Increment the TOP field in the FPU status register.

Description

Adds one to the TOP field of the FPU status word (increments the top-of-stack pointer). If the TOP field contains a 7, it is set to 0. The effect of this instruction is to rotate the stack by one position. The contents of the FPU data registers and tag register are not affected. This operation is not equivalent to popping the stack, because the tag for the previous top-of-stack register is not marked empty.

This instruction's operation is the same in non-64-bit modes and 64-bit mode.

Operation

```
IF TOP = 7
  THEN TOP ← 0;
  ELSE TOP ← TOP + 1;
FI;
```

FPU Flags Affected

The C1 flag is set to 0. The C0, C2, and C3 flags are undefined.

Floating-Point Exceptions

None.

Protected Mode Exceptions

#NM CRO.EM[bit 2] or CRO.TS[bit 3] = 1.
 #MF If there is a pending x87 FPU exception.
 #UD If the LOCK prefix is used.

Real-Address Mode Exceptions

Same exceptions as in protected mode.

Virtual-8086 Mode Exceptions

Same exceptions as in protected mode.

Compatibility Mode Exceptions

Same exceptions as in protected mode.

64-Bit Mode Exceptions

Same exceptions as in protected mode.

FINIT/FNINIT—Initialize Floating-Point Unit

Opcode	Instruction	64-Bit Mode	Compat/ Leg Mode	Description
9B DB E3	FINIT	Valid	Valid	Initialize FPU after checking for pending unmasked floating-point exceptions.
DB E3	FNINIT*	Valid	Valid	Initialize FPU without checking for pending unmasked floating-point exceptions.

NOTES:

* See IA-32 Architecture Compatibility section below.

Description

Sets the FPU control, status, tag, instruction pointer, and data pointer registers to their default states. The FPU control word is set to 037FH (round to nearest, all exceptions masked, 64-bit precision). The status word is cleared (no exception flags set, TOP is set to 0). The data registers in the register stack are left unchanged, but they are all tagged as empty (11B). Both the instruction and data pointers are cleared.

The FINIT instruction checks for and handles any pending unmasked floating-point exceptions before performing the initialization; the FNINIT instruction does not.

The assembler issues two instructions for the FINIT instruction (an FWAIT instruction followed by an FNINIT instruction), and the processor executes each of these instructions in separately. If an exception is generated for either of these instructions, the save EIP points to the instruction that caused the exception.

This instruction's operation is the same in non-64-bit modes and 64-bit mode.

IA-32 Architecture Compatibility

When operating a Pentium or Intel486 processor in MS-DOS compatibility mode, it is possible (under unusual circumstances) for an FNINIT instruction to be interrupted prior to being executed to handle a pending FPU exception. See the section titled "No-Wait FPU Instructions Can Get FPU Interrupt in Window" in Appendix D of the *Intel® 64 and IA-32 Architectures Software Developer's Manual, Volume 1*, for a description of these circumstances. An FNINIT instruction cannot be interrupted in this way on a Pentium 4, Intel Xeon, or P6 family processor.

In the Intel387 math coprocessor, the FINIT/FNINIT instruction does not clear the instruction and data pointers.

This instruction affects only the x87 FPU. It does not affect the XMM and MXCSR registers.

Operation

FPUControlWord \leftarrow 037FH;
 FPUStatusWord \leftarrow 0;
 FPUTagWord \leftarrow FFFFH;
 FPUDataPointer \leftarrow 0;
 FPUInstructionPointer \leftarrow 0;
 FPULastInstructionOpcode \leftarrow 0;

FPU Flags Affected

C0, C1, C2, C3 set to 0.

Floating-Point Exceptions

None.

Protected Mode Exceptions

#NM	CR0.EM[bit 2] or CR0.TS[bit 3] = 1.
#MF	If there is a pending x87 FPU exception.
#UD	If the LOCK prefix is used.

Real-Address Mode Exceptions

Same exceptions as in protected mode.

Virtual-8086 Mode Exceptions

Same exceptions as in protected mode.

Compatibility Mode Exceptions

Same exceptions as in protected mode.

64-Bit Mode Exceptions

Same exceptions as in protected mode.

FIST/FISTP—Store Integer

Opcode	Instruction	64-Bit Mode	Compat/ Leg Mode	Description
DF /2	FIST <i>m16int</i>	Valid	Valid	Store ST(0) in <i>m16int</i> .
DB /2	FIST <i>m32int</i>	Valid	Valid	Store ST(0) in <i>m32int</i> .
DF /3	FISTP <i>m16int</i>	Valid	Valid	Store ST(0) in <i>m16int</i> and pop register stack.
DB /3	FISTP <i>m32int</i>	Valid	Valid	Store ST(0) in <i>m32int</i> and pop register stack.
DF /7	FISTP <i>m64int</i>	Valid	Valid	Store ST(0) in <i>m64int</i> and pop register stack.

Description

The FIST instruction converts the value in the ST(0) register to a signed integer and stores the result in the destination operand. Values can be stored in word or double-word integer format. The destination operand specifies the address where the first byte of the destination value is to be stored.

The FISTP instruction performs the same operation as the FIST instruction and then pops the register stack. To pop the register stack, the processor marks the ST(0) register as empty and increments the stack pointer (TOP) by 1. The FISTP instruction also stores values in quadword integer format.

The following table shows the results obtained when storing various classes of numbers in integer format.

Table 3-40. FIST/FISTP Results

ST(0)	DEST
-• or Value Too Large for DEST Format	*
$F \leq -1$	-
$-1 < F < -0$	**
- 0	0
+ 0	0
$+0 < F < +1$	**
$F \geq +1$	+
+• or Value Too Large for DEST Format	*

Table 3-40. FIST/FISTP Results (Contd.)

ST(0)	DEST
NaN	*

NOTES:
 F Means finite floating-point value.
 I Means integer.
 * Indicates floating-point invalid-operation (#IA) exception.
 ** 0 or ± 1 , depending on the rounding mode.

If the source value is a non-integral value, it is rounded to an integer value, according to the rounding mode specified by the RC field of the FPU control word.

If the converted value is too large for the destination format, or if the source operand is an ∞ , SNaN, QNaN, or is in an unsupported format, an invalid-arithmic-operand condition is signaled. If the invalid-operation exception is not masked, an invalid-arithmic-operand exception (#IA) is generated and no value is stored in the destination operand. If the invalid-operation exception is masked, the integer indefinite value is stored in memory.

This instruction's operation is the same in non-64-bit modes and 64-bit mode.

Operation

DEST \leftarrow Integer(ST(0));

```
IF Instruction = FISTP
  THEN
    PopRegisterStack;
FI;
```

FPU Flags Affected

C1 Set to 0 if stack underflow occurred.
 Indicates rounding direction of if the inexact exception (#P) is generated: 0 \leftarrow not roundup; 1 \leftarrow roundup.
 Set to 0 otherwise.

C0, C2, C3 Undefined.

Floating-Point Exceptions

#IS Stack underflow occurred.
 #IA Converted value is too large for the destination format.
 Source operand is an SNaN, QNaN, $\pm\infty$, or unsupported format.
 #P Value cannot be represented exactly in destination format.

Protected Mode Exceptions

#GP(0)	If the destination is located in a non-writable segment. If a memory operand effective address is outside the CS, DS, ES, FS, or GS segment limit. If the DS, ES, FS, or GS register is used to access memory and it contains a NULL segment selector.
#SS(0)	If a memory operand effective address is outside the SS segment limit.
#NM	CR0.EM[bit 2] or CR0.TS[bit 3] = 1.
#PF(fault-code)	If a page fault occurs.
#AC(0)	If alignment checking is enabled and an unaligned memory reference is made while the current privilege level is 3.
#UD	If the LOCK prefix is used.

Real-Address Mode Exceptions

#GP	If a memory operand effective address is outside the CS, DS, ES, FS, or GS segment limit.
#SS	If a memory operand effective address is outside the SS segment limit.
#NM	CR0.EM[bit 2] or CR0.TS[bit 3] = 1.
#UD	If the LOCK prefix is used.

Virtual-8086 Mode Exceptions

#GP(0)	If a memory operand effective address is outside the CS, DS, ES, FS, or GS segment limit.
#SS(0)	If a memory operand effective address is outside the SS segment limit.
#NM	CR0.EM[bit 2] or CR0.TS[bit 3] = 1.
#PF(fault-code)	If a page fault occurs.
#AC(0)	If alignment checking is enabled and an unaligned memory reference is made.
#UD	If the LOCK prefix is used.

Compatibility Mode Exceptions

Same exceptions as in protected mode.

64-Bit Mode Exceptions

#SS(0)	If a memory address referencing the SS segment is in a non-canonical form.
#GP(0)	If the memory address is in a non-canonical form.

#NM	CRO.EM[bit 2] or CRO.TS[bit 3] = 1.
#MF	If there is a pending x87 FPU exception.
#PF(fault-code)	If a page fault occurs.
#AC(0)	If alignment checking is enabled and an unaligned memory reference is made while the current privilege level is 3.
#UD	If the LOCK prefix is used.

FISTTP—Store Integer with Truncation

Opcode	Instruction	64-Bit Mode	Compat/ Leg Mode	Description
DF /1	FISTTP <i>m16int</i>	Valid	Valid	Store ST(0) in <i>m16int</i> with truncation.
DB /1	FISTTP <i>m32int</i>	Valid	Valid	Store ST(0) in <i>m32int</i> with truncation.
DD /1	FISTTP <i>m64int</i>	Valid	Valid	Store ST(0) in <i>m64int</i> with truncation.

Description

FISTTP converts the value in ST into a signed integer using truncation (chop) as rounding mode, transfers the result to the destination, and pop ST. FISTTP accepts word, short integer, and long integer destinations.

The following table shows the results obtained when storing various classes of numbers in integer format.

Table 3-41. FISTTP Results

ST(0)	DEST
-• or Value Too Large for DEST Format	*
$F \leq -I$	$-I$
$-1 < F < +I$	0
$F \leq +I$	$+I$
+• or Value Too Large for DEST Format	*
NaN	*

NOTES:

F Means finite floating-point value.

I Means integer.

* Indicates floating-point invalid-operation (#IA) exception.

This instruction's operation is the same in non-64-bit modes and 64-bit mode.

Operation

DEST ← ST;

pop ST;

Flags Affected

C1 is cleared; C0, C2, C3 undefined.

Numeric Exceptions

Invalid, Stack Invalid (stack underflow), Precision.

Protected Mode Exceptions

#GP(0)	If the destination is in a nonwritable segment. For an illegal memory operand effective address in the CS, DS, ES, FS or GS segments.
#SS(0)	For an illegal address in the SS segment.
#PF(fault-code)	For a page fault.
#AC(0)	If alignment checking is enabled and an unaligned memory reference is made while the current privilege level is 3.
#NM	If CR0.EM[bit 2] = 1. If CR0.TS[bit 3] = 1.
#UD	If CPUID.01H: ECX.SSE3[bit 0] = 0. If the LOCK prefix is used.

Real Address Mode Exceptions

GP(0)	If any part of the operand would lie outside of the effective address space from 0 to 0FFFFH.
#NM	If CR0.EM[bit 2] = 1. If CR0.TS[bit 3] = 1.
#UD	If CPUID.01H: ECX.SSE3[bit 0] = 0. If the LOCK prefix is used.

Virtual 8086 Mode Exceptions

GP(0)	If any part of the operand would lie outside of the effective address space from 0 to 0FFFFH.
#NM	If CR0.EM[bit 2] = 1. If CR0.TS[bit 3] = 1.
#UD	If CPUID.01H: ECX.SSE3[bit 0] = 0. If the LOCK prefix is used.
#PF(fault-code)	For a page fault.
#AC(0)	For unaligned memory reference if the current privilege is 3.

Compatibility Mode Exceptions

Same exceptions as in protected mode.

64-Bit Mode Exceptions

#SS(0)	If a memory address referencing the SS segment is in a non-canonical form.
#GP(0)	If the memory address is in a non-canonical form.
#NM	CR0.EM[bit 2] or CR0.TS[bit 3] = 1.
#MF	If there is a pending x87 FPU exception.
#PF(fault-code)	If a page fault occurs.
#AC(0)	If alignment checking is enabled and an unaligned memory reference is made while the current privilege level is 3. If the LOCK prefix is used.

FLD—Load Floating Point Value

Opcode	Instruction	64-Bit Mode	Compat/ Leg Mode	Description
D9 /0	FLD <i>m32fp</i>	Valid	Valid	Push <i>m32fp</i> onto the FPU register stack.
DD /0	FLD <i>m64fp</i>	Valid	Valid	Push <i>m64fp</i> onto the FPU register stack.
DB /5	FLD <i>m80fp</i>	Valid	Valid	Push <i>m80fp</i> onto the FPU register stack.
D9 C0+i	FLD ST(i)	Valid	Valid	Push ST(i) onto the FPU register stack.

Description

Pushes the source operand onto the FPU register stack. The source operand can be in single-precision, double-precision, or double extended-precision floating-point format. If the source operand is in single-precision or double-precision floating-point format, it is automatically converted to the double extended-precision floating-point format before being pushed on the stack.

The FLD instruction can also push the value in a selected FPU register [ST(i)] onto the stack. Here, pushing register ST(0) duplicates the stack top.

This instruction's operation is the same in non-64-bit modes and 64-bit mode.

Operation

IF SRC is ST(i)

THEN

temp ← ST(i);

FI;

TOP ← TOP – 1;

IF SRC is memory-operand

THEN

ST(0) ← ConvertToDoubleExtendedPrecisionFP(SRC);

ELSE (* SRC is ST(i) *)

ST(0) ← temp;

FI;

FPU Flags Affected

C1 Set to 1 if stack overflow occurred; otherwise, set to 0.

C0, C2, C3 Undefined.

Floating-Point Exceptions

#IS Stack underflow or overflow occurred.

- #IA Source operand is an SNaN. Does not occur if the source operand is in double extended-precision floating-point format (FLD m80fp or FLD ST(i)).
- #D Source operand is a denormal value. Does not occur if the source operand is in double extended-precision floating-point format.

Protected Mode Exceptions

- #GP(0) If destination is located in a non-writable segment.
If a memory operand effective address is outside the CS, DS, ES, FS, or GS segment limit.
If the DS, ES, FS, or GS register is used to access memory and it contains a NULL segment selector.
- #SS(0) If a memory operand effective address is outside the SS segment limit.
- #NM CR0.EM[bit 2] or CR0.TS[bit 3] = 1.
- #PF(fault-code) If a page fault occurs.
- #AC(0) If alignment checking is enabled and an unaligned memory reference is made while the current privilege level is 3.
- #UD If the LOCK prefix is used.

Real-Address Mode Exceptions

- #GP If a memory operand effective address is outside the CS, DS, ES, FS, or GS segment limit.
- #SS If a memory operand effective address is outside the SS segment limit.
- #NM CR0.EM[bit 2] or CR0.TS[bit 3] = 1.
- #UD If the LOCK prefix is used.

Virtual-8086 Mode Exceptions

- #GP(0) If a memory operand effective address is outside the CS, DS, ES, FS, or GS segment limit.
- #SS(0) If a memory operand effective address is outside the SS segment limit.
- #NM CR0.EM[bit 2] or CR0.TS[bit 3] = 1.
- #PF(fault-code) If a page fault occurs.
- #AC(0) If alignment checking is enabled and an unaligned memory reference is made.
- #UD If the LOCK prefix is used.

Compatibility Mode Exceptions

Same exceptions as in protected mode.

64-Bit Mode Exceptions

#SS(0)	If a memory address referencing the SS segment is in a non-canonical form.
#GP(0)	If the memory address is in a non-canonical form.
#NM	CR0.EM[bit 2] or CR0.TS[bit 3] = 1.
#MF	If there is a pending x87 FPU exception.
#PF(fault-code)	If a page fault occurs.
#AC(0)	If alignment checking is enabled and an unaligned memory reference is made while the current privilege level is 3.
#UD	If the LOCK prefix is used.

FLD1/FLDL2T/FLDL2E/FLDPI/FLDLG2/FLDLN2/FLDZ—Load Constant

Opcode*	Instruction	64-Bit Mode	Compat/ Leg Mode	Description
D9 E8	FLD1	Valid	Valid	Push +1.0 onto the FPU register stack.
D9 E9	FLDL2T	Valid	Valid	Push $\log_2 10$ onto the FPU register stack.
D9 EA	FLDL2E	Valid	Valid	Push $\log_2 e$ onto the FPU register stack.
D9 EB	FLDPI	Valid	Valid	Push π onto the FPU register stack.
D9 EC	FLDLG2	Valid	Valid	Push $\log_{10} 2$ onto the FPU register stack.
D9 ED	FLDLN2	Valid	Valid	Push $\log_e 2$ onto the FPU register stack.
D9 EE	FLDZ	Valid	Valid	Push +0.0 onto the FPU register stack.

NOTES:

* See IA-32 Architecture Compatibility section below.

Description

Push one of seven commonly used constants (in double extended-precision floating-point format) onto the FPU register stack. The constants that can be loaded with these instructions include +1.0, +0.0, $\log_2 10$, $\log_2 e$, π , $\log_{10} 2$, and $\log_e 2$. For each constant, an internal 66-bit constant is rounded (as specified by the RC field in the FPU control word) to double extended-precision floating-point format. The inexact-result exception (#P) is not generated as a result of the rounding, nor is the C1 flag set in the x87 FPU status word if the value is rounded up.

See the section titled “Pi” in Chapter 8 of the *Intel® 64 and IA-32 Architectures Software Developer’s Manual, Volume 1*, for a description of the π constant.

This instruction’s operation is the same in non-64-bit modes and 64-bit mode.

IA-32 Architecture Compatibility

When the RC field is set to round-to-nearest, the FPU produces the same constants that is produced by the Intel 8087 and Intel 287 math coprocessors.

Operation

TOP \leftarrow TOP – 1;
ST(0) \leftarrow CONSTANT;

FPU Flags Affected

C1 Set to 1 if stack overflow occurred; otherwise, set to 0.
C0, C2, C3 Undefined.

Floating-Point Exceptions

#IS Stack overflow occurred.

Protected Mode Exceptions

#NM CR0.EM[bit 2] or CR0.TS[bit 3] = 1.
#MF If there is a pending x87 FPU exception.
#UD If the LOCK prefix is used.

Real-Address Mode Exceptions

Same exceptions as in protected mode.

Virtual-8086 Mode Exceptions

Same exceptions as in protected mode.

Virtual-8086 Mode Exceptions

Same exceptions as in protected mode.

Compatibility Mode Exceptions

Same exceptions as in protected mode.

64-Bit Mode Exceptions

Same exceptions as in protected mode.

FLDCW—Load x87 FPU Control Word

Opcode	Instruction	64-Bit Mode	Compat/ Leg Mode	Description
D9 /5	FLDCW m2byte	Valid	Valid	Load FPU control word from <i>m2byte</i> .

Description

Loads the 16-bit source operand into the FPU control word. The source operand is a memory location. This instruction is typically used to establish or change the FPU's mode of operation.

If one or more exception flags are set in the FPU status word prior to loading a new FPU control word and the new control word unmask one or more of those exceptions, a floating-point exception will be generated upon execution of the next floating-point instruction (except for the no-wait floating-point instructions, see the section titled "Software Exception Handling" in Chapter 8 of the *Intel® 64 and IA-32 Architectures Software Developer's Manual, Volume 1*). To avoid raising exceptions when changing FPU operating modes, clear any pending exceptions (using the FCLEX or FNCLEX instruction) before loading the new control word.

This instruction's operation is the same in non-64-bit modes and 64-bit mode.

Operation

FPUControlWord ← SRC;

FPU Flags Affected

C0, C1, C2, C3 undefined.

Floating-Point Exceptions

None; however, this operation might unmask a pending exception in the FPU status word. That exception is then generated upon execution of the next "waiting" floating-point instruction.

Protected Mode Exceptions

#GP(0)	If a memory operand effective address is outside the CS, DS, ES, FS, or GS segment limit. If the DS, ES, FS, or GS register is used to access memory and it contains a NULL segment selector.
#SS(0)	If a memory operand effective address is outside the SS segment limit.
#NM	CR0.EM[bit 2] or CR0.TS[bit 3] = 1.
#PF(fault-code)	If a page fault occurs.

#AC(0)	If alignment checking is enabled and an unaligned memory reference is made while the current privilege level is 3.
#UD	If the LOCK prefix is used.

Real-Address Mode Exceptions

#GP	If a memory operand effective address is outside the CS, DS, ES, FS, or GS segment limit.
#SS	If a memory operand effective address is outside the SS segment limit.
#NM	CR0.EM[bit 2] or CR0.TS[bit 3] = 1.
#UD	If the LOCK prefix is used.

Virtual-8086 Mode Exceptions

#GP(0)	If a memory operand effective address is outside the CS, DS, ES, FS, or GS segment limit.
#SS(0)	If a memory operand effective address is outside the SS segment limit.
#NM	CR0.EM[bit 2] or CR0.TS[bit 3] = 1.
#PF(fault-code)	If a page fault occurs.
#AC(0)	If alignment checking is enabled and an unaligned memory reference is made.
#UD	If the LOCK prefix is used.

Compatibility Mode Exceptions

Same exceptions as in protected mode.

64-Bit Mode Exceptions

#SS(0)	If a memory address referencing the SS segment is in a non-canonical form.
#GP(0)	If the memory address is in a non-canonical form.
#NM	CR0.EM[bit 2] or CR0.TS[bit 3] = 1.
#MF	If there is a pending x87 FPU exception.
#PF(fault-code)	If a page fault occurs.
#AC(0)	If alignment checking is enabled and an unaligned memory reference is made while the current privilege level is 3.
#UD	If the LOCK prefix is used.

FLDENV—Load x87 FPU Environment

Opcode	Instruction	64-Bit Mode	Compat/ Leg Mode	Description
D9 /4	FLDENV <i>m14/28byte</i>	Valid	Valid	Load FPU environment from <i>m14byte</i> or <i>m28byte</i> .

Description

Loads the complete x87 FPU operating environment from memory into the FPU registers. The source operand specifies the first byte of the operating-environment data in memory. This data is typically written to the specified memory location by a FSTENV or FNSTENV instruction.

The FPU operating environment consists of the FPU control word, status word, tag word, instruction pointer, data pointer, and last opcode. Figures 8-9 through 8-12 in the *Intel® 64 and IA-32 Architectures Software Developer's Manual, Volume 1*, show the layout in memory of the loaded environment, depending on the operating mode of the processor (protected or real) and the current operand-size attribute (16-bit or 32-bit). In virtual-8086 mode, the real mode layouts are used.

The FLDENV instruction should be executed in the same operating mode as the corresponding FSTENV/FNSTENV instruction.

If one or more unmasked exception flags are set in the new FPU status word, a floating-point exception will be generated upon execution of the next floating-point instruction (except for the no-wait floating-point instructions, see the section titled “Software Exception Handling” in Chapter 8 of the *Intel® 64 and IA-32 Architectures Software Developer's Manual, Volume 1*). To avoid generating exceptions when loading a new environment, clear all the exception flags in the FPU status word that is being loaded.

If a page or limit fault occurs during the execution of this instruction, the state of the x87 FPU registers as seen by the fault handler may be different than the state being loaded from memory. In such situations, the fault handler should ignore the status of the x87 FPU registers, handle the fault, and return. The FLDENV instruction will then complete the loading of the x87 FPU registers with no resulting context inconsistency.

This instruction's operation is the same in non-64-bit modes and 64-bit mode.

Operation

```

FPUControlWord ← SRC[FPUControlWord];
FPUStatusWord ← SRC[FPUStatusWord];
FPUTagWord ← SRC[FPUTagWord];
FPUDataPointer ← SRC[FPUDataPointer];
FPUInstructionPointer ← SRC[FPUInstructionPointer];
FPULastInstructionOpcode ← SRC[FPULastInstructionOpcode];

```

FPU Flags Affected

The C0, C1, C2, C3 flags are loaded.

Floating-Point Exceptions

None; however, if an unmasked exception is loaded in the status word, it is generated upon execution of the next “waiting” floating-point instruction.

Protected Mode Exceptions

#GP(0)	If a memory operand effective address is outside the CS, DS, ES, FS, or GS segment limit. If the DS, ES, FS, or GS register is used to access memory and it contains a NULL segment selector.
#SS(0)	If a memory operand effective address is outside the SS segment limit.
#NM	CR0.EM[bit 2] or CR0.TS[bit 3] = 1.
#PF(fault-code)	If a page fault occurs.
#AC(0)	If alignment checking is enabled and an unaligned memory reference is made while the current privilege level is 3.
#UD	If the LOCK prefix is used.

Real-Address Mode Exceptions

#GP	If a memory operand effective address is outside the CS, DS, ES, FS, or GS segment limit.
#SS	If a memory operand effective address is outside the SS segment limit.
#NM	CR0.EM[bit 2] or CR0.TS[bit 3] = 1.
#UD	If the LOCK prefix is used.

Virtual-8086 Mode Exceptions

#GP(0)	If a memory operand effective address is outside the CS, DS, ES, FS, or GS segment limit.
#SS(0)	If a memory operand effective address is outside the SS segment limit.
#NM	CR0.EM[bit 2] or CR0.TS[bit 3] = 1.
#PF(fault-code)	If a page fault occurs.
#AC(0)	If alignment checking is enabled and an unaligned memory reference is made.
#UD	If the LOCK prefix is used.

Compatibility Mode Exceptions

Same exceptions as in protected mode.

64-Bit Mode Exceptions

#SS(0)	If a memory address referencing the SS segment is in a non-canonical form.
#GP(0)	If the memory address is in a non-canonical form.
#NM	CR0.EM[bit 2] or CR0.TS[bit 3] = 1.
#MF	If there is a pending x87 FPU exception.
#PF(fault-code)	If a page fault occurs.
#AC(0)	If alignment checking is enabled and an unaligned memory reference is made while the current privilege level is 3.
#UD	If the LOCK prefix is used.

FMUL/FMULP/FIMUL—Multiply

Opcode	Instruction	64-Bit Mode	Compat/ Leg Mode	Description
D8 /1	FMUL <i>m32fp</i>	Valid	Valid	Multiply ST(0) by <i>m32fp</i> and store result in ST(0).
DC /1	FMUL <i>m64fp</i>	Valid	Valid	Multiply ST(0) by <i>m64fp</i> and store result in ST(0).
D8 C8+i	FMUL ST(0), ST(i)	Valid	Valid	Multiply ST(0) by ST(i) and store result in ST(0).
DC C8+i	FMUL ST(i), ST(0)	Valid	Valid	Multiply ST(i) by ST(0) and store result in ST(i).
DE C8+i	FMULP ST(i), ST(0)	Valid	Valid	Multiply ST(i) by ST(0), store result in ST(i), and pop the register stack.
DE C9	FMULP	Valid	Valid	Multiply ST(1) by ST(0), store result in ST(1), and pop the register stack.
DA /1	FIMUL <i>m32int</i>	Valid	Valid	Multiply ST(0) by <i>m32int</i> and store result in ST(0).
DE /1	FIMUL <i>m16int</i>	Valid	Valid	Multiply ST(0) by <i>m16int</i> and store result in ST(0).

Description

Multiplies the destination and source operands and stores the product in the destination location. The destination operand is always an FPU data register; the source operand can be an FPU data register or a memory location. Source operands in memory can be in single-precision or double-precision floating-point format or in word or doubleword integer format.

The no-operand version of the instruction multiplies the contents of the ST(1) register by the contents of the ST(0) register and stores the product in the ST(1) register. The one-operand version multiplies the contents of the ST(0) register by the contents of a memory location (either a floating point or an integer value) and stores the product in the ST(0) register. The two-operand version, multiplies the contents of the ST(0) register by the contents of the ST(i) register, or vice versa, with the result being stored in the register specified with the first operand (the destination operand).

The FMULP instructions perform the additional operation of popping the FPU register stack after storing the product. To pop the register stack, the processor marks the ST(0) register as empty and increments the stack pointer (TOP) by 1. The no-operand version of the floating-point multiply instructions always results in the register stack being popped. In some assemblers, the mnemonic for this instruction is FMUL rather than FMULP.

The FIMUL instructions convert an integer source operand to double extended-precision floating-point format before performing the multiplication.

The sign of the result is always the exclusive-OR of the source signs, even if one or more of the values being multiplied is 0 or ∞. When the source operand is an integer 0, it is treated as a +0.

The following table shows the results obtained when multiplying various classes of numbers, assuming that neither overflow nor underflow occurs.

Table 3-42. FMUL/FMULP/FIMUL Results

		DEST						
		-.•	-F	-0	+0	+F	+•	NaN
SRC	-.•	+•	+•	*	*	-.•	-.•	NaN
	-F	+•	+F	+0	-0	-F	-.•	NaN
	-I	+•	+F	+0	-0	-F	-.•	NaN
	-0	*	+0	+0	-0	-0	*	NaN
	+0	*	-0	-0	+0	+0	*	NaN
	+I	-.•	-F	-0	+0	+F	+•	NaN
	+F	-.•	-F	-0	+0	+F	+•	NaN
	+•	-.•	-.•	*	*	+•	+•	NaN
	NaN	NaN	NaN	NaN	NaN	NaN	NaN	NaN

NOTES:

- F Means finite floating-point value.
- I Means Integer.
- * Indicates invalid-arithmetic-operand (#IA) exception.

This instruction’s operation is the same in non-64-bit modes and 64-bit mode.

Operation

```
IF Instruction = FIMUL
    THEN
        DEST ← DEST * ConvertToDoubleExtendedPrecisionFP(SRC);
    ELSE (* Source operand is floating-point value *)
        DEST ← DEST * SRC;
```

FI;

```
IF Instruction = FMULP
    THEN
        PopRegisterStack;
```

FI;

FPU Flags Affected

C1	Set to 0 if stack underflow occurred. Set if result was rounded up; cleared otherwise.
C0, C2, C3	Undefined.

Floating-Point Exceptions

#IS	Stack underflow occurred.
#IA	Operand is an SNaN value or unsupported format. One operand is ± 0 and the other is $\pm \infty$.
#D	Source operand is a denormal value.
#U	Result is too small for destination format.
#O	Result is too large for destination format.
#P	Value cannot be represented exactly in destination format.

Protected Mode Exceptions

#GP(0)	If a memory operand effective address is outside the CS, DS, ES, FS, or GS segment limit. If the DS, ES, FS, or GS register is used to access memory and it contains a NULL segment selector.
#SS(0)	If a memory operand effective address is outside the SS segment limit.
#NM	CR0.EM[bit 2] or CR0.TS[bit 3] = 1.
#PF(fault-code)	If a page fault occurs.
#AC(0)	If alignment checking is enabled and an unaligned memory reference is made while the current privilege level is 3.
#UD	If the LOCK prefix is used.

Real-Address Mode Exceptions

#GP	If a memory operand effective address is outside the CS, DS, ES, FS, or GS segment limit.
#SS	If a memory operand effective address is outside the SS segment limit.
#NM	CR0.EM[bit 2] or CR0.TS[bit 3] = 1.
#UD	If the LOCK prefix is used.

Virtual-8086 Mode Exceptions

#GP(0)	If a memory operand effective address is outside the CS, DS, ES, FS, or GS segment limit.
#SS(0)	If a memory operand effective address is outside the SS segment limit.

INSTRUCTION SET REFERENCE, A-M

#NM	CR0.EM[bit 2] or CR0.TS[bit 3] = 1.
#PF(fault-code)	If a page fault occurs.
#AC(0)	If alignment checking is enabled and an unaligned memory reference is made.
#UD	If the LOCK prefix is used.

Compatibility Mode Exceptions

Same exceptions as in protected mode.

64-Bit Mode Exceptions

#SS(0)	If a memory address referencing the SS segment is in a non-canonical form.
#GP(0)	If the memory address is in a non-canonical form.
#NM	CR0.EM[bit 2] or CR0.TS[bit 3] = 1.
#MF	If there is a pending x87 FPU exception.
#PF(fault-code)	If a page fault occurs.
#AC(0)	If alignment checking is enabled and an unaligned memory reference is made while the current privilege level is 3.
#UD	If the LOCK prefix is used.

FNOP—No Operation

Opcode	Instruction	64-Bit Mode	Compat/ Leg Mode	Description
D9 D0	FNOP	Valid	Valid	No operation is performed.

Description

Performs no FPU operation. This instruction takes up space in the instruction stream but does not affect the FPU or machine context, except the EIP register.

This instruction's operation is the same in non-64-bit modes and 64-bit mode.

FPU Flags Affected

C0, C1, C2, C3 undefined.

Floating-Point Exceptions

None.

Protected Mode Exceptions

- #NM CRO.EM[bit 2] or CRO.TS[bit 3] = 1.
- #MF If there is a pending x87 FPU exception.
- #UD If the LOCK prefix is used.

Real-Address Mode Exceptions

Same exceptions as in protected mode.

Virtual-8086 Mode Exceptions

Same exceptions as in protected mode.

Compatibility Mode Exceptions

Same exceptions as in protected mode.

64-Bit Mode Exceptions

Same exceptions as in protected mode.

FPATAN—Partial Arctangent

Opcode*	Instruction	64-Bit Mode	Compat/ Leg Mode	Description
D9 F3	FPATAN	Valid	Valid	Replace ST(1) with $\arctan(\text{ST}(1)/\text{ST}(0))$ and pop the register stack.

NOTES:

- * See IA-32 Architecture Compatibility section below.

Description

Computes the arctangent of the source operand in register ST(1) divided by the source operand in register ST(0), stores the result in ST(1), and pops the FPU register stack. The result in register ST(0) has the same sign as the source operand ST(1) and a magnitude less than $+\pi$.

The FPATAN instruction returns the angle between the X axis and the line from the origin to the point (X,Y), where Y (the ordinate) is ST(1) and X (the abscissa) is ST(0). The angle depends on the sign of X and Y independently, not just on the sign of the ratio Y/X. This is because a point $(-X,Y)$ is in the second quadrant, resulting in an angle between $\pi/2$ and π , while a point $(X,-Y)$ is in the fourth quadrant, resulting in an angle between 0 and $-\pi/2$. A point $(-X,-Y)$ is in the third quadrant, giving an angle between $-\pi/2$ and $-\pi$.

The following table shows the results obtained when computing the arctangent of various classes of numbers, assuming that underflow does not occur.

Table 3-43. FPATAN Results

		ST(0)						NaN
		-•	-F	-0	+0	+F	+•	
ST(1)	-•	$-3\pi/4^*$	$-\pi/2$	$-\pi/2$	$-\pi/2$	$-\pi/2$	$-\pi/4^*$	NaN
	-F	-p	$-\pi$ to $-\pi/2$	$-\pi/2$	$-\pi/2$	$-\pi/2$ to -0	-0	NaN
	-0	-p	-p	$-p^*$	-0^*	-0	-0	NaN
	+0	+p	+p	$+\pi^*$	$+0^*$	+0	+0	NaN
	+F	+p	$+\pi$ to $+\pi/2$	$+\pi/2$	$+\pi/2$	$+\pi/2$ to $+0$	+0	NaN
	+•	$+3\pi/4^*$	$+\pi/2$	$+\pi/2$	$+\pi/2$	$+\pi/2$	$+\pi/4^*$	NaN
	NaN	NaN	NaN	NaN	NaN	NaN	NaN	NaN

NOTES:

F Means finite floating-point value.

* Table 8-10 in the *Intel® 64 and IA-32 Architectures Software Developer's Manual, Volume 1*, specifies that the ratios 0/0 and •/• generate the floating-point invalid arithmetic-operation exception and, if this exception is masked, the floating-point QNaN indefinite value is returned. With the FPATAN instruction, the 0/0 or •/• value is actually not calculated using division. Instead, the arctangent of the two variables is derived from a standard mathematical formulation that is generalized to allow complex numbers as arguments. In this complex variable formulation, $\arctan(0,0)$ etc. has well defined values. These values are needed to develop a library to compute transcendental functions with complex arguments, based on the FPU functions that only allow floating-point values as arguments.

There is no restriction on the range of source operands that FPATAN can accept.

This instruction's operation is the same in non-64-bit modes and 64-bit mode.

IA-32 Architecture Compatibility

The source operands for this instruction are restricted for the 80287 math coprocessor to the following range:

$$0 \leq |ST(1)| < |ST(0)| < +\infty$$

Operation

$ST(1) \leftarrow \arctan(ST(1) / ST(0));$

PopRegisterStack;

FPU Flags Affected

C1	Set to 0 if stack underflow occurred. Set if result was rounded up; cleared otherwise.
C0, C2, C3	Undefined.

Floating-Point Exceptions

#IS	Stack underflow occurred.
#IA	Source operand is an SNaN value or unsupported format.
#D	Source operand is a denormal value.
#U	Result is too small for destination format.
#P	Value cannot be represented exactly in destination format.

Protected Mode Exceptions

#NM	CR0.EM[bit 2] or CR0.TS[bit 3] = 1.
#MF	If there is a pending x87 FPU exception.
#UD	If the LOCK prefix is used.

Real-Address Mode Exceptions

Same exceptions as in protected mode.

Virtual-8086 Mode Exceptions

Same exceptions as in protected mode.

Compatibility Mode Exceptions

Same exceptions as in protected mode.

64-Bit Mode Exceptions

Same exceptions as in protected mode.

FPREM—Partial Remainder

Opcode	Instruction	64-Bit Mode	Compat/ Leg Mode	Description
D9 F8	FPREM	Valid	Valid	Replace ST(0) with the remainder obtained from dividing ST(0) by ST(1).

Description

Computes the remainder obtained from dividing the value in the ST(0) register (the dividend) by the value in the ST(1) register (the divisor or **modulus**), and stores the result in ST(0). The remainder represents the following value:

$$\text{Remainder} \leftarrow \text{ST}(0) - (Q * \text{ST}(1))$$

Here, Q is an integer value that is obtained by truncating the floating-point number quotient of $[\text{ST}(0) / \text{ST}(1)]$ toward zero. The sign of the remainder is the same as the sign of the dividend. The magnitude of the remainder is less than that of the modulus, unless a partial remainder was computed (as described below).

This instruction produces an exact result; the inexact-result exception does not occur and the rounding control has no effect. The following table shows the results obtained when computing the remainder of various classes of numbers, assuming that underflow does not occur.

Table 3-44. FPREM Results

		ST(1)						
		-.•	-F	-0	+0	+F	+•	
ST(0)	-.•	*	*	*	*	*	*	NaN
	-F	ST(0)	-F or -0	**	**	-F or -0	ST(0)	NaN
	-0	-0	-0	*	*	-0	-0	NaN
	+0	+0	+0	*	*	+0	+0	NaN
	+F	ST(0)	+F or +0	**	**	+F or +0	ST(0)	NaN
	+•	*	*	*	*	*	*	NaN
	NaN	NaN	NaN	NaN	NaN	NaN	NaN	NaN

NOTES:

F Means finite floating-point value.

* Indicates floating-point invalid-arithmetic-operand (#IA) exception.

** Indicates floating-point zero-divide (#Z) exception.

When the result is 0, its sign is the same as that of the dividend. When the modulus is ∞ , the result is equal to the value in ST(0).

The FPREM instruction does not compute the remainder specified in IEEE Std 754. The IEEE specified remainder can be computed with the FPREM1 instruction. The FPREM instruction is provided for compatibility with the Intel 8087 and Intel287 math coprocessors.

The FPREM instruction gets its name “partial remainder” because of the way it computes the remainder. This instruction arrives at a remainder through iterative subtraction. It can, however, reduce the exponent of ST(0) by no more than 63 in one execution of the instruction. If the instruction succeeds in producing a remainder that is less than the modulus, the operation is complete and the C2 flag in the FPU status word is cleared. Otherwise, C2 is set, and the result in ST(0) is called the **partial remainder**. The exponent of the partial remainder will be less than the exponent of the original dividend by at least 32. Software can re-execute the instruction (using the partial remainder in ST(0) as the dividend) until C2 is cleared. (Note that while executing such a remainder-computation loop, a higher-priority interrupting routine that needs the FPU can force a context switch in-between the instructions in the loop.)

An important use of the FPREM instruction is to reduce the arguments of periodic functions. When reduction is complete, the instruction stores the three least-significant bits of the quotient in the C3, C1, and C0 flags of the FPU status word. This information is important in argument reduction for the tangent function (using a modulus of $\pi/4$), because it locates the original angle in the correct one of eight sectors of the unit circle.

This instruction’s operation is the same in non-64-bit modes and 64-bit mode.

Operation

$D \leftarrow \text{exponent}(\text{ST}(0)) - \text{exponent}(\text{ST}(1));$

IF $D < 64$

THEN

$Q \leftarrow \text{Integer}(\text{TruncateTowardZero}(\text{ST}(0) / \text{ST}(1)));$

$\text{ST}(0) \leftarrow \text{ST}(0) - (\text{ST}(1) * Q);$

$C2 \leftarrow 0;$

$C0, C3, C1 \leftarrow \text{LeastSignificantBits}(Q); (* Q2, Q1, Q0 *)$

ELSE

$C2 \leftarrow 1;$

$N \leftarrow \text{An implementation-dependent number between 32 and 63};$

$QQ \leftarrow \text{Integer}(\text{TruncateTowardZero}((\text{ST}(0) / \text{ST}(1)) / 2^{(D-N)}));$

$\text{ST}(0) \leftarrow \text{ST}(0) - (\text{ST}(1) * QQ * 2^{(D-N)});$

FI;

FPU Flags Affected

C0	Set to bit 2 (Q2) of the quotient.
C1	Set to 0 if stack underflow occurred; otherwise, set to least significant bit of quotient (Q0).
C2	Set to 0 if reduction complete; set to 1 if incomplete.
C3	Set to bit 1 (Q1) of the quotient.

Floating-Point Exceptions

#IS	Stack underflow occurred.
#IA	Source operand is an SNaN value, modulus is 0, dividend is ∞ , or unsupported format.
#D	Source operand is a denormal value.
#U	Result is too small for destination format.

Protected Mode Exceptions

#NM	CR0.EM[bit 2] or CR0.TS[bit 3] = 1.
#MF	If there is a pending x87 FPU exception.
#UD	If the LOCK prefix is used.

Real-Address Mode Exceptions

Same exceptions as in protected mode.

Virtual-8086 Mode Exceptions

Same exceptions as in protected mode.

Compatibility Mode Exceptions

Same exceptions as in protected mode.

64-Bit Mode Exceptions

Same exceptions as in protected mode.

FPREM1—Partial Remainder

Opcode	Instruction	64-Bit Mode	Compat/ Leg Mode	Description
D9 F5	FPREM1	Valid	Valid	Replace ST(0) with the IEEE remainder obtained from dividing ST(0) by ST(1).

Description

Computes the IEEE remainder obtained from dividing the value in the ST(0) register (the dividend) by the value in the ST(1) register (the divisor or **modulus**), and stores the result in ST(0). The remainder represents the following value:

$$\text{Remainder} \leftarrow \text{ST}(0) - (Q * \text{ST}(1))$$

Here, Q is an integer value that is obtained by rounding the floating-point number quotient of [ST(0) / ST(1)] toward the nearest integer value. The magnitude of the remainder is less than or equal to half the magnitude of the modulus, unless a partial remainder was computed (as described below).

This instruction produces an exact result; the precision (inexact) exception does not occur and the rounding control has no effect. The following table shows the results obtained when computing the remainder of various classes of numbers, assuming that underflow does not occur.

Table 3-45. FPREM1 Results

		ST(1)						NaN
		-∞	-F	-0	+0	+F	+∞	
ST(0)	-∞	*	*	*	*	*	*	NaN
	-F	ST(0)	±F or -0	**	**	±F or -0	ST(0)	NaN
	-0	-0	-0	*	*	-0	-0	NaN
	+0	+0	+0	*	*	+0	+0	NaN
	+F	ST(0)	±F or +0	**	**	±F or +0	ST(0)	NaN
	+∞	*	*	*	*	*	*	NaN
	NaN	NaN	NaN	NaN	NaN	NaN	NaN	NaN

NOTES:

- F Means finite floating-point value.
- * Indicates floating-point invalid-arithmetic-operand (#IA) exception.
- ** Indicates floating-point zero-divide (#Z) exception.

When the result is 0, its sign is the same as that of the dividend. When the modulus is ∞, the result is equal to the value in ST(0).

The FPREM1 instruction computes the remainder specified in IEEE Standard 754. This instruction operates differently from the FPREM instruction in the way that it rounds the quotient of ST(0) divided by ST(1) to an integer (see the “Operation” section below).

Like the FPREM instruction, FPREM1 computes the remainder through iterative subtraction, but can reduce the exponent of ST(0) by no more than 63 in one execution of the instruction. If the instruction succeeds in producing a remainder that is less than one half the modulus, the operation is complete and the C2 flag in the FPU status word is cleared. Otherwise, C2 is set, and the result in ST(0) is called the **partial remainder**. The exponent of the partial remainder will be less than the exponent of the original dividend by at least 32. Software can re-execute the instruction (using the partial remainder in ST(0) as the dividend) until C2 is cleared. (Note that while executing such a remainder-computation loop, a higher-priority interrupting routine that needs the FPU can force a context switch in-between the instructions in the loop.)

An important use of the FPREM1 instruction is to reduce the arguments of periodic functions. When reduction is complete, the instruction stores the three least-significant bits of the quotient in the C3, C1, and C0 flags of the FPU status word. This information is important in argument reduction for the tangent function (using a modulus of $\pi/4$), because it locates the original angle in the correct one of eight sectors of the unit circle.

This instruction’s operation is the same in non-64-bit modes and 64-bit mode.

Operation

$D \leftarrow \text{exponent}(\text{ST}(0)) - \text{exponent}(\text{ST}(1));$

IF $D < 64$

THEN

$Q \leftarrow \text{Integer}(\text{RoundTowardNearestInteger}(\text{ST}(0) / \text{ST}(1)));$

$\text{ST}(0) \leftarrow \text{ST}(0) - (\text{ST}(1) * Q);$

$C2 \leftarrow 0;$

$C0, C3, C1 \leftarrow \text{LeastSignificantBits}(Q); (* Q2, Q1, Q0 *)$

ELSE

$C2 \leftarrow 1;$

$N \leftarrow \text{An implementation-dependent number between 32 and 63};$

$QQ \leftarrow \text{Integer}(\text{TruncateTowardZero}((\text{ST}(0) / \text{ST}(1)) / 2^{(D-N)}));$

$\text{ST}(0) \leftarrow \text{ST}(0) - (\text{ST}(1) * QQ * 2^{(D-N)});$

FI;

FPU Flags Affected

C0 Set to bit 2 (Q2) of the quotient.

C1 Set to 0 if stack underflow occurred; otherwise, set to least significant bit of quotient (Q0).

C2	Set to 0 if reduction complete; set to 1 if incomplete.
C3	Set to bit 1 (Q1) of the quotient.

Floating-Point Exceptions

#IS	Stack underflow occurred.
#IA	Source operand is an SNaN value, modulus (divisor) is 0, dividend is ∞ , or unsupported format.
#D	Source operand is a denormal value.
#U	Result is too small for destination format.

Protected Mode Exceptions

#NM	CR0.EM[bit 2] or CR0.TS[bit 3] = 1.
#MF	If there is a pending x87 FPU exception.
#UD	If the LOCK prefix is used.

Real-Address Mode Exceptions

Same exceptions as in protected mode.

Virtual-8086 Mode Exceptions

Same exceptions as in protected mode.

Compatibility Mode Exceptions

Same exceptions as in protected mode.

64-Bit Mode Exceptions

Same exceptions as in protected mode.

FPTAN—Partial Tangent

Opcode	Instruction	64-Bit Mode	Compat/ Leg Mode	Description
D9 F2	FPTAN	Valid	Valid	Replace ST(0) with its tangent and push 1 onto the FPU stack.

Description

Computes the tangent of the source operand in register ST(0), stores the result in ST(0), and pushes a 1.0 onto the FPU register stack. The source operand must be given in radians and must be less than $\pm 2^{63}$. The following table shows the unmasked results obtained when computing the partial tangent of various classes of numbers, assuming that underflow does not occur.

Table 3-46. FPTAN Results

ST(0) SRC	ST(0) DEST
-*	*
- F	- F to + F
- 0	- 0
+ 0	+ 0
+ F	- F to + F
+*	*
NaN	NaN

NOTES:

F Means finite floating-point value.

* Indicates floating-point invalid-arithmetic-operand (#IA) exception.

If the source operand is outside the acceptable range, the C2 flag in the FPU status word is set, and the value in register ST(0) remains unchanged. The instruction does not raise an exception when the source operand is out of range. It is up to the program to check the C2 flag for out-of-range conditions. Source values outside the range -2^{63} to $+2^{63}$ can be reduced to the range of the instruction by subtracting an appropriate integer multiple of 2π or by using the FPREM instruction with a divisor of 2π . See the section titled "Pi" in Chapter 8 of the *Intel® 64 and IA-32 Architectures Software Developer's Manual, Volume 1*, for a discussion of the proper value to use for π in performing such reductions.

The value 1.0 is pushed onto the register stack after the tangent has been computed to maintain compatibility with the Intel 8087 and Intel287 math coprocessors. This operation also simplifies the calculation of other trigonometric functions. For instance, the cotangent (which is the reciprocal of the tangent) can be computed by executing a FDIVR instruction after the FPTAN instruction.

This instruction's operation is the same in non-64-bit modes and 64-bit mode.

Operation

```
IF ST(0) < 263
  THEN
    C2 ← 0;
    ST(0) ← tan(ST(0));
    TOP ← TOP – 1;
    ST(0) ← 1.0;
  ELSE (* Source operand is out-of-range *)
    C2 ← 1;
FI;
```

FPU Flags Affected

C1	Set to 0 if stack underflow occurred; set to 1 if stack overflow occurred.
	Set if result was rounded up; cleared otherwise.
C2	Set to 1 if outside range ($-2^{63} < \text{source operand} < +2^{63}$); otherwise, set to 0.
C0, C3	Undefined.

Floating-Point Exceptions

#IS	Stack underflow or overflow occurred.
#IA	Source operand is an SNaN value, ∞ , or unsupported format.
#D	Source operand is a denormal value.
#U	Result is too small for destination format.
#P	Value cannot be represented exactly in destination format.

Protected Mode Exceptions

#NM	CR0.EM[bit 2] or CR0.TS[bit 3] = 1.
#MF	If there is a pending x87 FPU exception.
#UD	If the LOCK prefix is used.

Real-Address Mode Exceptions

Same exceptions as in protected mode.

Virtual-8086 Mode Exceptions

Same exceptions as in protected mode.

Compatibility Mode Exceptions

Same exceptions as in protected mode.

64-Bit Mode Exceptions

Same exceptions as in protected mode.

FRNDINT—Round to Integer

Opcode	Instruction	64-Bit Mode	Compat/ Leg Mode	Description
D9 FC	FRNDINT	Valid	Valid	Round ST(0) to an integer.

Description

Rounds the source value in the ST(0) register to the nearest integral value, depending on the current rounding mode (setting of the RC field of the FPU control word), and stores the result in ST(0).

If the source value is ∞ , the value is not changed. If the source value is not an integral value, the floating-point inexact-result exception (#P) is generated.

This instruction's operation is the same in non-64-bit modes and 64-bit mode.

Operation

ST(0) \leftarrow RoundToIntegralValue(ST(0));

FPU Flags Affected

C1	Set to 0 if stack underflow occurred. Set if result was rounded up; cleared otherwise.
C0, C2, C3	Undefined.

Floating-Point Exceptions

#IS	Stack underflow occurred.
#IA	Source operand is an SNaN value or unsupported format.
#D	Source operand is a denormal value.
#P	Source operand is not an integral value.

Protected Mode Exceptions

#NM	CR0.EM[bit 2] or CR0.TS[bit 3] = 1.
#MF	If there is a pending x87 FPU exception.
#UD	If the LOCK prefix is used.

Real-Address Mode Exceptions

Same exceptions as in protected mode.

Virtual-8086 Mode Exceptions

Same exceptions as in protected mode.

Compatibility Mode Exceptions

Same exceptions as in protected mode.

64-Bit Mode Exceptions

Same exceptions as in protected mode.

FRSTOR—Restore x87 FPU State

Opcode	Instruction	64-Bit Mode	Compat/ Leg Mode	Description
DD /4	FRSTOR <i>m94/108byte</i>	Valid	Valid	Load FPU state from <i>m94byte</i> or <i>m108byte</i> .

Description

Loads the FPU state (operating environment and register stack) from the memory area specified with the source operand. This state data is typically written to the specified memory location by a previous FSAVE/FNSAVE instruction.

The FPU operating environment consists of the FPU control word, status word, tag word, instruction pointer, data pointer, and last opcode. Figures 8-9 through 8-12 in the *Intel® 64 and IA-32 Architectures Software Developer's Manual, Volume 1*, show the layout in memory of the stored environment, depending on the operating mode of the processor (protected or real) and the current operand-size attribute (16-bit or 32-bit). In virtual-8086 mode, the real mode layouts are used. The contents of the FPU register stack are stored in the 80 bytes immediately following the operating environment image.

The FRSTOR instruction should be executed in the same operating mode as the corresponding FSAVE/FNSAVE instruction.

If one or more unmasked exception bits are set in the new FPU status word, a floating-point exception will be generated. To avoid raising exceptions when loading a new operating environment, clear all the exception flags in the FPU status word that is being loaded.

This instruction's operation is the same in non-64-bit modes and 64-bit mode.

Operation

```

FPUControlWord ← SRC[FPUControlWord];
FPUStatusWord ← SRC[FPUStatusWord];
FPUTagWord ← SRC[FPUTagWord];
FPUDataPointer ← SRC[FPUDataPointer];
FPUInstructionPointer ← SRC[FPUInstructionPointer];
FPULastInstructionOpcode ← SRC[FPULastInstructionOpcode];

```

```

ST(0) ← SRC[ST(0)];
ST(1) ← SRC[ST(1)];
ST(2) ← SRC[ST(2)];
ST(3) ← SRC[ST(3)];
ST(4) ← SRC[ST(4)];
ST(5) ← SRC[ST(5)];
ST(6) ← SRC[ST(6)];

```

ST(7) ← SRC[ST(7)];

FPU Flags Affected

The C0, C1, C2, C3 flags are loaded.

Floating-Point Exceptions

None; however, this operation might unmask an existing exception that has been detected but not generated, because it was masked. Here, the exception is generated at the completion of the instruction.

Protected Mode Exceptions

#GP(0)	If a memory operand effective address is outside the CS, DS, ES, FS, or GS segment limit. If the DS, ES, FS, or GS register is used to access memory and it contains a NULL segment selector.
#SS(0)	If a memory operand effective address is outside the SS segment limit.
#NM	CR0.EM[bit 2] or CR0.TS[bit 3] = 1.
#PF(fault-code)	If a page fault occurs.
#AC(0)	If alignment checking is enabled and an unaligned memory reference is made while the current privilege level is 3.
#UD	If the LOCK prefix is used.

Real-Address Mode Exceptions

#GP	If a memory operand effective address is outside the CS, DS, ES, FS, or GS segment limit.
#SS	If a memory operand effective address is outside the SS segment limit.
#NM	CR0.EM[bit 2] or CR0.TS[bit 3] = 1.
#UD	If the LOCK prefix is used.

Virtual-8086 Mode Exceptions

#GP(0)	If a memory operand effective address is outside the CS, DS, ES, FS, or GS segment limit.
#SS(0)	If a memory operand effective address is outside the SS segment limit.
#NM	CR0.EM[bit 2] or CR0.TS[bit 3] = 1.
#PF(fault-code)	If a page fault occurs.

#AC(0)	If alignment checking is enabled and an unaligned memory reference is made.
#UD	If the LOCK prefix is used.

Compatibility Mode Exceptions

Same exceptions as in protected mode.

64-Bit Mode Exceptions

#SS(0)	If a memory address referencing the SS segment is in a non-canonical form.
#GP(0)	If the memory address is in a non-canonical form.
#NM	CR0.EM[bit 2] or CR0.TS[bit 3] = 1.
#PF(fault-code)	If a page fault occurs.
#AC(0)	If alignment checking is enabled and an unaligned memory reference is made while the current privilege level is 3.
#UD	If the LOCK prefix is used.

FSAVE/FNSAVE—Store x87 FPU State

Opcode	Instruction	64-Bit Mode	Compat/ Leg Mode	Description
9B DD /6	FSAVE <i>m94/108byte</i>	Valid	Valid	Store FPU state to <i>m94byte</i> or <i>m108byte</i> after checking for pending unmasked floating-point exceptions. Then re-initialize the FPU.
DD /6	FNSAVE* <i>m94/108byte</i>	Valid	Valid	Store FPU environment to <i>m94byte</i> or <i>m108byte</i> without checking for pending unmasked floating-point exceptions. Then re-initialize the FPU.

NOTES:

* See IA-32 Architecture Compatibility section below.

Description

Stores the current FPU state (operating environment and register stack) at the specified destination in memory, and then re-initializes the FPU. The FSAVE instruction checks for and handles pending unmasked floating-point exceptions before storing the FPU state; the FNSAVE instruction does not.

The FPU operating environment consists of the FPU control word, status word, tag word, instruction pointer, data pointer, and last opcode. Figures 8-9 through 8-12 in the *Intel® 64 and IA-32 Architectures Software Developer's Manual, Volume 1*, show the layout in memory of the stored environment, depending on the operating mode of the processor (protected or real) and the current operand-size attribute (16-bit or 32-bit). In virtual-8086 mode, the real mode layouts are used. The contents of the FPU register stack are stored in the 80 bytes immediately follow the operating environment image.

The saved image reflects the state of the FPU after all floating-point instructions preceding the FSAVE/FNSAVE instruction in the instruction stream have been executed.

After the FPU state has been saved, the FPU is reset to the same default values it is set to with the FINIT/FNINIT instructions (see “FINIT/FNINIT—Initialize Floating-Point Unit” in this chapter).

The FSAVE/FNSAVE instructions are typically used when the operating system needs to perform a context switch, an exception handler needs to use the FPU, or an application program needs to pass a “clean” FPU to a procedure.

The assembler issues two instructions for the FSAVE instruction (an FWAIT instruction followed by an FNSAVE instruction), and the processor executes each of these

instructions separately. If an exception is generated for either of these instructions, the save EIP points to the instruction that caused the exception.

This instruction's operation is the same in non-64-bit modes and 64-bit mode.

IA-32 Architecture Compatibility

For Intel math coprocessors and FPUs prior to the Intel Pentium processor, an FWAIT instruction should be executed before attempting to read from the memory image stored with a prior FSAVE/FNSAVE instruction. This FWAIT instruction helps insure that the storage operation has been completed.

When operating a Pentium or Intel486 processor in MS-DOS compatibility mode, it is possible (under unusual circumstances) for an FNSAVE instruction to be interrupted prior to being executed to handle a pending FPU exception. See the section titled "No-Wait FPU Instructions Can Get FPU Interrupt in Window" in Appendix D of the *Intel® 64 and IA-32 Architectures Software Developer's Manual, Volume 1*, for a description of these circumstances. An FNSAVE instruction cannot be interrupted in this way on a Pentium 4, Intel Xeon, or P6 family processor.

Operation

(* Save FPU State and Registers *)

```
DEST[FPUControlWord] ← FPUControlWord;
DEST[FPUStatusWord] ← FPUStatusWord;
DEST[FPUTagWord] ← FPUTagWord;
DEST[FPUDataPointer] ← FPUDataPointer;
DEST[FPUInstructionPointer] ← FPUInstructionPointer;
DEST[FPULastInstructionOpcode] ← FPULastInstructionOpcode;
```

```
DEST[ST(0)] ← ST(0);
DEST[ST(1)] ← ST(1);
DEST[ST(2)] ← ST(2);
DEST[ST(3)] ← ST(3);
DEST[ST(4)] ← ST(4);
DEST[ST(5)] ← ST(5);
DEST[ST(6)] ← ST(6);
DEST[ST(7)] ← ST(7);
```

(* Initialize FPU *)

```
FPUControlWord ← 037FH;
FPUStatusWord ← 0;
FPUTagWord ← FFFFH;
FPUDataPointer ← 0;
FPUInstructionPointer ← 0;
FPULastInstructionOpcode ← 0;
```

FPU Flags Affected

The C0, C1, C2, and C3 flags are saved and then cleared.

Floating-Point Exceptions

None.

Protected Mode Exceptions

#GP(0)	If destination is located in a non-writable segment. If a memory operand effective address is outside the CS, DS, ES, FS, or GS segment limit. If the DS, ES, FS, or GS register is used to access memory and it contains a NULL segment selector.
#SS(0)	If a memory operand effective address is outside the SS segment limit.
#NM	CR0.EM[bit 2] or CR0.TS[bit 3] = 1.
#PF(fault-code)	If a page fault occurs.
#AC(0)	If alignment checking is enabled and an unaligned memory reference is made while the current privilege level is 3.
#UD	If the LOCK prefix is used.

Real-Address Mode Exceptions

#GP	If a memory operand effective address is outside the CS, DS, ES, FS, or GS segment limit.
#SS	If a memory operand effective address is outside the SS segment limit.
#NM	CR0.EM[bit 2] or CR0.TS[bit 3] = 1.
#UD	If the LOCK prefix is used.

Virtual-8086 Mode Exceptions

#GP(0)	If a memory operand effective address is outside the CS, DS, ES, FS, or GS segment limit.
#SS(0)	If a memory operand effective address is outside the SS segment limit.
#NM	CR0.EM[bit 2] or CR0.TS[bit 3] = 1.
#PF(fault-code)	If a page fault occurs.
#AC(0)	If alignment checking is enabled and an unaligned memory reference is made.
#UD	If the LOCK prefix is used.

Compatibility Mode Exceptions

Same exceptions as in protected mode.

64-Bit Mode Exceptions

#SS(0)	If a memory address referencing the SS segment is in a non-canonical form.
#GP(0)	If the memory address is in a non-canonical form.
#NM	CR0.EM[bit 2] or CR0.TS[bit 3] = 1.
#MF	If there is a pending x87 FPU exception.
#PF(fault-code)	If a page fault occurs.
#AC(0)	If alignment checking is enabled and an unaligned memory reference is made while the current privilege level is 3.

FSCALE—Scale

Opcode	Instruction	64-Bit Mode	Compat/ Leg Mode	Description
D9 FD	FSCALE	Valid	Valid	Scale ST(0) by ST(1).

Description

Truncates the value in the source operand (toward 0) to an integral value and adds that value to the exponent of the destination operand. The destination and source operands are floating-point values located in registers ST(0) and ST(1), respectively. This instruction provides rapid multiplication or division by integral powers of 2. The following table shows the results obtained when scaling various classes of numbers, assuming that neither overflow nor underflow occurs.

Table 3-47. FSCALE Results

		ST(1)						
		-•	-F	-0	+0	+F	+•	NaN
ST(0)	-•	NaN	-•	-•	-•	-•	-•	NaN
	-F	-0	-F	-F	-F	-F	-•	NaN
	-0	-0	-0	-0	-0	-0	NaN	NaN
	+0	+0	+0	+0	+0	+0	NaN	NaN
	+F	+0	+F	+F	+F	+F	+•	NaN
	+•	NaN	+•	+•	+•	+•	+•	NaN
	NaN	NaN	NaN	NaN	NaN	NaN	NaN	NaN

NOTES:

F Means finite floating-point value.

In most cases, only the exponent is changed and the mantissa (significand) remains unchanged. However, when the value being scaled in ST(0) is a denormal value, the mantissa is also changed and the result may turn out to be a normalized number. Similarly, if overflow or underflow results from a scale operation, the resulting mantissa will differ from the source's mantissa.

The FSCALE instruction can also be used to reverse the action of the FXTRACT instruction, as shown in the following example:

```
FXTRACT;
FSCALE;
FSTP ST(1);
```

In this example, the FXTRACT instruction extracts the significand and exponent from the value in ST(0) and stores them in ST(0) and ST(1) respectively. The FSCALE then scales the significand in ST(0) by the exponent in ST(1), recreating the original value

before the FEXTRACT operation was performed. The FSTP ST(1) instruction overwrites the exponent (extracted by the FEXTRACT instruction) with the recreated value, which returns the stack to its original state with only one register [ST(0)] occupied.

This instruction's operation is the same in non-64-bit modes and 64-bit mode.

Operation

$$ST(0) \leftarrow ST(0) * 2^{\text{RoundTowardZero}(ST(1))};$$

FPU Flags Affected

C1	Set to 0 if stack underflow occurred. Set if result was rounded up; cleared otherwise.
C0, C2, C3	Undefined.

Floating-Point Exceptions

#IS	Stack underflow occurred.
#IA	Source operand is an SNaN value or unsupported format.
#D	Source operand is a denormal value.
#U	Result is too small for destination format.
#O	Result is too large for destination format.
#P	Value cannot be represented exactly in destination format.

Protected Mode Exceptions

#NM	CR0.EM[bit 2] or CR0.TS[bit 3] = 1.
#MF	If there is a pending x87 FPU exception.
#UD	If the LOCK prefix is used.

Real-Address Mode Exceptions

Same exceptions as in protected mode.

Virtual-8086 Mode Exceptions

Same exceptions as in protected mode.

Compatibility Mode Exceptions

Same exceptions as in protected mode.

64-Bit Mode Exceptions

Same exceptions as in protected mode.

FSIN—Sine

Opcode	Instruction	64-Bit Mode	Compat/ Leg Mode	Description
D9 FE	FSIN	Valid	Valid	Replace ST(0) with its sine.

Description

Computes the sine of the source operand in register ST(0) and stores the result in ST(0). The source operand must be given in radians and must be within the range -2^{63} to $+2^{63}$. The following table shows the results obtained when taking the sine of various classes of numbers, assuming that underflow does not occur.

Table 3-48. FSIN Results

SRC (ST(0))	DEST (ST(0))
- •	*
- F	- 1 to + 1
- 0	-0
+ 0	+ 0
+ F	- 1 to +1
+ •	*
NaN	NaN

NOTES:

F Means finite floating-point value.

* Indicates floating-point invalid-arithmetic-operand (#IA) exception.

If the source operand is outside the acceptable range, the C2 flag in the FPU status word is set, and the value in register ST(0) remains unchanged. The instruction does not raise an exception when the source operand is out of range. It is up to the program to check the C2 flag for out-of-range conditions. Source values outside the range -2^{63} to $+2^{63}$ can be reduced to the range of the instruction by subtracting an appropriate integer multiple of 2π or by using the FPREM instruction with a divisor of 2π . See the section titled "Pi" in Chapter 8 of the *Intel® 64 and IA-32 Architectures Software Developer's Manual, Volume 1*, for a discussion of the proper value to use for π in performing such reductions.

This instruction's operation is the same in non-64-bit modes and 64-bit mode.

Operation

```
IF ST(0) < 263
  THEN
    C2 ← 0;
```

```

    ST(0) ← sin(ST(0));
    ELSE (* Source operand out of range *)
        C2 ← 1;
FI;

```

FPU Flags Affected

C1	Set to 0 if stack underflow occurred. Set if result was rounded up; cleared otherwise.
C2	Set to 1 if outside range ($-2^{63} < \text{source operand} < +2^{63}$); otherwise, set to 0.
C0, C3	Undefined.

Floating-Point Exceptions

#IS	Stack underflow occurred.
#IA	Source operand is an SNaN value, ∞ , or unsupported format.
#D	Source operand is a denormal value.
#P	Value cannot be represented exactly in destination format.

Protected Mode Exceptions

#NM	CR0.EM[bit 2] or CR0.TS[bit 3] = 1.
#MF	If there is a pending x87 FPU exception.
#UD	If the LOCK prefix is used.

Real-Address Mode Exceptions

Same exceptions as in protected mode.

Virtual-8086 Mode Exceptions

Same exceptions as in protected mode.

Compatibility Mode Exceptions

Same exceptions as in protected mode.

64-Bit Mode Exceptions

Same exceptions as in protected mode.

FSINCOS—Sine and Cosine

Opcode	Instruction	64-Bit Mode	Compat/ Leg Mode	Description
D9 FB	FSINCOS	Valid	Valid	Compute the sine and cosine of ST(0); replace ST(0) with the sine, and push the cosine onto the register stack.

Description

Computes both the sine and the cosine of the source operand in register ST(0), stores the sine in ST(0), and pushes the cosine onto the top of the FPU register stack. (This instruction is faster than executing the FSIN and FCOS instructions in succession.)

The source operand must be given in radians and must be within the range -2^{63} to $+2^{63}$. The following table shows the results obtained when taking the sine and cosine of various classes of numbers, assuming that underflow does not occur.

Table 3-49. FSINCOS Results

SRC	DEST	
	ST(1) Cosine	ST(0) Sine
ST(0)		
-•	*	*
- F	- 1 to + 1	- 1 to + 1
- 0	+ 1	- 0
+ 0	+ 1	+ 0
+ F	- 1 to + 1	- 1 to + 1
+•	*	*
NaN	NaN	NaN

NOTES:

F Means finite floating-point value.

* Indicates floating-point invalid-arithmetic-operand (#IA) exception.

If the source operand is outside the acceptable range, the C2 flag in the FPU status word is set, and the value in register ST(0) remains unchanged. The instruction does not raise an exception when the source operand is out of range. It is up to the program to check the C2 flag for out-of-range conditions. Source values outside the range -2^{63} to $+2^{63}$ can be reduced to the range of the instruction by subtracting an appropriate integer multiple of 2π or by using the FPREM instruction with a divisor of 2π . See the section titled "Pi" in Chapter 8 of the *Intel® 64 and IA-32 Architectures Software Developer's Manual, Volume 1*, for a discussion of the proper value to use for π in performing such reductions.

This instruction's operation is the same in non-64-bit modes and 64-bit mode.

Operation

```

IF ST(0) < 263
  THEN
    C2 ← 0;
    TEMP ← cosine(ST(0));
    ST(0) ← sine(ST(0));
    TOP ← TOP – 1;
    ST(0) ← TEMP;
  ELSE (* Source operand out of range *)
    C2 ← 1;
FI;

```

FPU Flags Affected

C1	Set to 0 if stack underflow occurred; set to 1 if stack overflow occurs.
	Set if result was rounded up; cleared otherwise.
C2	Set to 1 if outside range ($-2^{63} < \text{source operand} < +2^{63}$); otherwise, set to 0.
C0, C3	Undefined.

Floating-Point Exceptions

#IS	Stack underflow or overflow occurred.
#IA	Source operand is an SNaN value, ∞ , or unsupported format.
#D	Source operand is a denormal value.
#U	Result is too small for destination format.
#P	Value cannot be represented exactly in destination format.

Protected Mode Exceptions

#NM	CR0.EM[bit 2] or CR0.TS[bit 3] = 1.
#MF	If there is a pending x87 FPU exception.
#UD	If the LOCK prefix is used.

Real-Address Mode Exceptions

Same exceptions as in protected mode.

Virtual-8086 Mode Exceptions

Same exceptions as in protected mode.

Compatibility Mode Exceptions

Same exceptions as in protected mode.

64-Bit Mode Exceptions

Same exceptions as in protected mode.

FSQRT—Square Root

Opcode	Instruction	64-Bit Mode	Compat/ Leg Mode	Description
D9 FA	FSQRT	Valid	Valid	Computes square root of ST(0) and stores the result in ST(0).

Description

Computes the square root of the source value in the ST(0) register and stores the result in ST(0).

The following table shows the results obtained when taking the square root of various classes of numbers, assuming that neither overflow nor underflow occurs.

Table 3-50. FSQRT Results

SRC (ST(0))	DEST (ST(0))
-•	*
- F	*
- 0	- 0
+ 0	+ 0
+ F	+ F
+•	+•
NaN	NaN

NOTES:

F Means finite floating-point value.

* Indicates floating-point invalid-arithmetic-operand (#IA) exception.

This instruction's operation is the same in non-64-bit modes and 64-bit mode.

Operation

ST(0) ← SquareRoot(ST(0));

FPU Flags Affected

C1	Set to 0 if stack underflow occurred.
	Set if result was rounded up; cleared otherwise.
C0, C2, C3	Undefined.

Floating-Point Exceptions

#IS	Stack underflow occurred.
#IA	Source operand is an SNaN value or unsupported format.

	Source operand is a negative value (except for -0).
#D	Source operand is a denormal value.
#P	Value cannot be represented exactly in destination format.

Protected Mode Exceptions

#NM	CRO.EM[bit 2] or CRO.TS[bit 3] = 1.
#MF	If there is a pending x87 FPU exception.
#UD	If the LOCK prefix is used.

Real-Address Mode Exceptions

Same exceptions as in protected mode.

Virtual-8086 Mode Exceptions

Same exceptions as in protected mode.

Compatibility Mode Exceptions

Same exceptions as in protected mode.

64-Bit Mode Exceptions

Same exceptions as in protected mode.

FST/FSTP—Store Floating Point Value

Opcode	Instruction	64-Bit Mode	Compat/Leg Mode	Description
D9 /2	FST <i>m32fp</i>	Valid	Valid	Copy ST(0) to <i>m32fp</i> .
DD /2	FST <i>m64fp</i>	Valid	Valid	Copy ST(0) to <i>m64fp</i> .
DD D0+i	FST ST(i)	Valid	Valid	Copy ST(0) to ST(i).
D9 /3	FSTP <i>m32fp</i>	Valid	Valid	Copy ST(0) to <i>m32fp</i> and pop register stack.
DD /3	FSTP <i>m64fp</i>	Valid	Valid	Copy ST(0) to <i>m64fp</i> and pop register stack.
DB /7	FSTP <i>m80fp</i>	Valid	Valid	Copy ST(0) to <i>m80fp</i> and pop register stack.
DD D8+i	FSTP ST(i)	Valid	Valid	Copy ST(0) to ST(i) and pop register stack.

Description

The FST instruction copies the value in the ST(0) register to the destination operand, which can be a memory location or another register in the FPU register stack. When storing the value in memory, the value is converted to single-precision or double-precision floating-point format.

The FSTP instruction performs the same operation as the FST instruction and then pops the register stack. To pop the register stack, the processor marks the ST(0) register as empty and increments the stack pointer (TOP) by 1. The FSTP instruction can also store values in memory in double extended-precision floating-point format.

If the destination operand is a memory location, the operand specifies the address where the first byte of the destination value is to be stored. If the destination operand is a register, the operand specifies a register in the register stack relative to the top of the stack.

If the destination size is single-precision or double-precision, the significand of the value being stored is rounded to the width of the destination (according to the rounding mode specified by the RC field of the FPU control word), and the exponent is converted to the width and bias of the destination format. If the value being stored is too large for the destination format, a numeric overflow exception (#O) is generated and, if the exception is unmasked, no value is stored in the destination operand. If the value being stored is a denormal value, the denormal exception (#D) is not generated. This condition is simply signaled as a numeric underflow exception (#U) condition.

If the value being stored is ± 0 , $\pm\infty$, or a NaN, the least-significant bits of the significand and the exponent are truncated to fit the destination format. This operation preserves the value's identity as a 0, ∞ , or NaN.

If the destination operand is a non-empty register, the invalid-operation exception is not generated.

This instruction's operation is the same in non-64-bit modes and 64-bit mode.

Operation

DEST ← ST(0);

IF Instruction = FSTP

THEN

PopRegisterStack;

FI;

FPU Flags Affected

C1	Set to 0 if stack underflow occurred. Indicates rounding direction of if the floating-point inexact exception (#P) is generated: 0 ← not roundup; 1 ← roundup.
C0, C2, C3	Undefined.

Floating-Point Exceptions

#IS	Stack underflow occurred.
#IA	Source operand is an SNaN value or unsupported format. Does not occur if the source operand is in double extended-precision floating-point format.
#U	Result is too small for the destination format.
#O	Result is too large for the destination format.
#P	Value cannot be represented exactly in destination format.

Protected Mode Exceptions

#GP(0)	If the destination is located in a non-writable segment. If a memory operand effective address is outside the CS, DS, ES, FS, or GS segment limit. If the DS, ES, FS, or GS register is used to access memory and it contains a NULL segment selector.
#SS(0)	If a memory operand effective address is outside the SS segment limit.
#NM	CR0.EM[bit 2] or CR0.TS[bit 3] = 1.
#PF(fault-code)	If a page fault occurs.
#AC(0)	If alignment checking is enabled and an unaligned memory reference is made while the current privilege level is 3.
#UD	If the LOCK prefix is used.

Real-Address Mode Exceptions

#GP	If a memory operand effective address is outside the CS, DS, ES, FS, or GS segment limit.
#SS	If a memory operand effective address is outside the SS segment limit.
#NM	CR0.EM[bit 2] or CR0.TS[bit 3] = 1.
#UD	If the LOCK prefix is used.

Virtual-8086 Mode Exceptions

#GP(0)	If a memory operand effective address is outside the CS, DS, ES, FS, or GS segment limit.
#SS(0)	If a memory operand effective address is outside the SS segment limit.
#NM	CR0.EM[bit 2] or CR0.TS[bit 3] = 1.
#PF(fault-code)	If a page fault occurs.
#AC(0)	If alignment checking is enabled and an unaligned memory reference is made.
#UD	If the LOCK prefix is used.

Compatibility Mode Exceptions

Same exceptions as in protected mode.

64-Bit Mode Exceptions

#SS(0)	If a memory address referencing the SS segment is in a non-canonical form.
#GP(0)	If the memory address is in a non-canonical form.
#NM	CR0.EM[bit 2] or CR0.TS[bit 3] = 1.
#MF	If there is a pending x87 FPU exception.
#PF(fault-code)	If a page fault occurs.
#AC(0)	If alignment checking is enabled and an unaligned memory reference is made while the current privilege level is 3.
#UD	If the LOCK prefix is used.

FSTCW/FNSTCW—Store x87 FPU Control Word

Opcode	Instruction	64-Bit Mode	Compat/ Leg Mode	Description
9B D9 /7	FSTCW <i>m2byte</i>	Valid	Valid	Store FPU control word to <i>m2byte</i> after checking for pending unmasked floating-point exceptions.
D9 /7	FNSTCW* <i>m2byte</i>	Valid	Valid	Store FPU control word to <i>m2byte</i> without checking for pending unmasked floating-point exceptions.

NOTES:

* See IA-32 Architecture Compatibility section below.

Description

Stores the current value of the FPU control word at the specified destination in memory. The FSTCW instruction checks for and handles pending unmasked floating-point exceptions before storing the control word; the FNSTCW instruction does not.

The assembler issues two instructions for the FSTCW instruction (an FWAIT instruction followed by an FNSTCW instruction), and the processor executes each of these instructions in separately. If an exception is generated for either of these instructions, the save EIP points to the instruction that caused the exception.

This instruction's operation is the same in non-64-bit modes and 64-bit mode.

IA-32 Architecture Compatibility

When operating a Pentium or Intel486 processor in MS-DOS compatibility mode, it is possible (under unusual circumstances) for an FNSTCW instruction to be interrupted prior to being executed to handle a pending FPU exception. See the section titled "No-Wait FPU Instructions Can Get FPU Interrupt in Window" in Appendix D of the *Intel® 64 and IA-32 Architectures Software Developer's Manual, Volume 1*, for a description of these circumstances. An FNSTCW instruction cannot be interrupted in this way on a Pentium 4, Intel Xeon, or P6 family processor.

Operation

DEST ← FPUControlWord;

FPU Flags Affected

The C0, C1, C2, and C3 flags are undefined.

Floating-Point Exceptions

None.

Protected Mode Exceptions

#GP(0)	If the destination is located in a non-writable segment. If a memory operand effective address is outside the CS, DS, ES, FS, or GS segment limit. If the DS, ES, FS, or GS register is used to access memory and it contains a NULL segment selector.
#SS(0)	If a memory operand effective address is outside the SS segment limit.
#NM	CR0.EM[bit 2] or CR0.TS[bit 3] = 1.
#PF(fault-code)	If a page fault occurs.
#AC(0)	If alignment checking is enabled and an unaligned memory reference is made while the current privilege level is 3.
#UD	If the LOCK prefix is used.

Real-Address Mode Exceptions

#GP	If a memory operand effective address is outside the CS, DS, ES, FS, or GS segment limit.
#SS	If a memory operand effective address is outside the SS segment limit.
#NM	CR0.EM[bit 2] or CR0.TS[bit 3] = 1.
#UD	If the LOCK prefix is used.

Virtual-8086 Mode Exceptions

#GP(0)	If a memory operand effective address is outside the CS, DS, ES, FS, or GS segment limit.
#SS(0)	If a memory operand effective address is outside the SS segment limit.
#NM	CR0.EM[bit 2] or CR0.TS[bit 3] = 1.
#PF(fault-code)	If a page fault occurs.
#AC(0)	If alignment checking is enabled and an unaligned memory reference is made.
#UD	If the LOCK prefix is used.

Compatibility Mode Exceptions

Same exceptions as in protected mode.

64-Bit Mode Exceptions

#SS(0)	If a memory address referencing the SS segment is in a non-canonical form.
#GP(0)	If the memory address is in a non-canonical form.

#NM	CRO.EM[bit 2] or CRO.TS[bit 3] = 1.
#MF	If there is a pending x87 FPU exception.
#PF(fault-code)	If a page fault occurs.
#AC(0)	If alignment checking is enabled and an unaligned memory reference is made while the current privilege level is 3.
#UD	If the LOCK prefix is used.

FSTENV/FNSTENV—Store x87 FPU Environment

Opcode	Instruction	64-Bit Mode	Compat/ Leg Mode	Description
9B D9 /6	FSTENV <i>m14/28byte</i>	Valid	Valid	Store FPU environment to <i>m14byte</i> or <i>m28byte</i> after checking for pending unmasked floating-point exceptions. Then mask all floating-point exceptions.
D9 /6	FNSTENV* <i>m14/28byte</i>	Valid	Valid	Store FPU environment to <i>m14byte</i> or <i>m28byte</i> without checking for pending unmasked floating-point exceptions. Then mask all floating-point exceptions.

NOTES:

* See IA-32 Architecture Compatibility section below.

Description

Saves the current FPU operating environment at the memory location specified with the destination operand, and then masks all floating-point exceptions. The FPU operating environment consists of the FPU control word, status word, tag word, instruction pointer, data pointer, and last opcode. Figures 8-9 through 8-12 in the *Intel® 64 and IA-32 Architectures Software Developer's Manual, Volume 1*, show the layout in memory of the stored environment, depending on the operating mode of the processor (protected or real) and the current operand-size attribute (16-bit or 32-bit). In virtual-8086 mode, the real mode layouts are used.

The FSTENV instruction checks for and handles any pending unmasked floating-point exceptions before storing the FPU environment; the FNSTENV instruction does not. The saved image reflects the state of the FPU after all floating-point instructions preceding the FSTENV/FNSTENV instruction in the instruction stream have been executed.

These instructions are often used by exception handlers because they provide access to the FPU instruction and data pointers. The environment is typically saved in the stack. Masking all exceptions after saving the environment prevents floating-point exceptions from interrupting the exception handler.

The assembler issues two instructions for the FSTENV instruction (an FWAIT instruction followed by an FNSTENV instruction), and the processor executes each of these instructions separately. If an exception is generated for either of these instructions, the save EIP points to the instruction that caused the exception.

This instruction's operation is the same in non-64-bit modes and 64-bit mode.

IA-32 Architecture Compatibility

When operating a Pentium or Intel486 processor in MS-DOS compatibility mode, it is possible (under unusual circumstances) for an FNSTENV instruction to be interrupted prior to being executed to handle a pending FPU exception. See the section titled “No-Wait FPU Instructions Can Get FPU Interrupt in Window” in Appendix D of the *Intel® 64 and IA-32 Architectures Software Developer’s Manual, Volume 1*, for a description of these circumstances. An FNSTENV instruction cannot be interrupted in this way on a Pentium 4, Intel Xeon, or P6 family processor.

Operation

```
DEST[FPUControlWord] ← FPUControlWord;
DEST[FPUStatusWord] ← FPUStatusWord;
DEST[FPUTagWord] ← FPUTagWord;
DEST[FPUDataPointer] ← FPUDataPointer;
DEST[FPUInstructionPointer] ← FPUInstructionPointer;
DEST[FPULastInstructionOpcode] ← FPULastInstructionOpcode;
```

FPU Flags Affected

The C0, C1, C2, and C3 are undefined.

Floating-Point Exceptions

None.

Protected Mode Exceptions

#GP(0)	If the destination is located in a non-writable segment. If a memory operand effective address is outside the CS, DS, ES, FS, or GS segment limit. If the DS, ES, FS, or GS register is used to access memory and it contains a NULL segment selector.
#SS(0)	If a memory operand effective address is outside the SS segment limit.
#NM	CR0.EM[bit 2] or CR0.TS[bit 3] = 1.
#PF(fault-code)	If a page fault occurs.
#AC(0)	If alignment checking is enabled and an unaligned memory reference is made while the current privilege level is 3.
#UD	If the LOCK prefix is used.

Real-Address Mode Exceptions

#GP	If a memory operand effective address is outside the CS, DS, ES, FS, or GS segment limit.
-----	-------------------------------------------------------------------------------------------

#SS	If a memory operand effective address is outside the SS segment limit.
#NM	CR0.EM[bit 2] or CR0.TS[bit 3] = 1.
#UD	If the LOCK prefix is used.

Virtual-8086 Mode Exceptions

#GP(0)	If a memory operand effective address is outside the CS, DS, ES, FS, or GS segment limit.
#SS(0)	If a memory operand effective address is outside the SS segment limit.
#NM	CR0.EM[bit 2] or CR0.TS[bit 3] = 1.
#PF(fault-code)	If a page fault occurs.
#AC(0)	If alignment checking is enabled and an unaligned memory reference is made.
#UD	If the LOCK prefix is used.

Compatibility Mode Exceptions

Same exceptions as in protected mode.

64-Bit Mode Exceptions

#SS(0)	If a memory address referencing the SS segment is in a non-canonical form.
#GP(0)	If the memory address is in a non-canonical form.
#NM	CR0.EM[bit 2] or CR0.TS[bit 3] = 1.
#MF	If there is a pending x87 FPU exception.
#PF(fault-code)	If a page fault occurs.
#AC(0)	If alignment checking is enabled and an unaligned memory reference is made while the current privilege level is 3.
#UD	If the LOCK prefix is used.

FSTSW/FNSTSW—Store x87 FPU Status Word

Opcode	Instruction	64-Bit Mode	Compat/ Leg Mode	Description
9B DD /7	FSTSW <i>m2byte</i>	Valid	Valid	Store FPU status word at <i>m2byte</i> after checking for pending unmasked floating-point exceptions.
9B DF E0	FSTSW AX	Valid	Valid	Store FPU status word in AX register after checking for pending unmasked floating-point exceptions.
DD /7	FNSTSW* <i>m2byte</i>	Valid	Valid	Store FPU status word at <i>m2byte</i> without checking for pending unmasked floating-point exceptions.
DF E0	FNSTSW* AX	Valid	Valid	Store FPU status word in AX register without checking for pending unmasked floating-point exceptions.

NOTES:

* See IA-32 Architecture Compatibility section below.

Description

Stores the current value of the x87 FPU status word in the destination location. The destination operand can be either a two-byte memory location or the AX register. The FSTSW instruction checks for and handles pending unmasked floating-point exceptions before storing the status word; the FNSTSW instruction does not.

The FNSTSW AX form of the instruction is used primarily in conditional branching (for instance, after an FPU comparison instruction or an FPREM, FPREM1, or FXAM instruction), where the direction of the branch depends on the state of the FPU condition code flags. (See the section titled “Branching and Conditional Moves on FPU Condition Codes” in Chapter 8 of the *Intel® 64 and IA-32 Architectures Software Developer’s Manual, Volume 1*.) This instruction can also be used to invoke exception handlers (by examining the exception flags) in environments that do not use interrupts. When the FNSTSW AX instruction is executed, the AX register is updated before the processor executes any further instructions. The status stored in the AX register is thus guaranteed to be from the completion of the prior FPU instruction.

The assembler issues two instructions for the FSTSW instruction (an FWAIT instruction followed by an FNSTSW instruction), and the processor executes each of these instructions separately. If an exception is generated for either of these instructions, the save EIP points to the instruction that caused the exception.

This instruction’s operation is the same in non-64-bit modes and 64-bit mode.

IA-32 Architecture Compatibility

When operating a Pentium or Intel486 processor in MS-DOS compatibility mode, it is possible (under unusual circumstances) for an FNSTSW instruction to be interrupted prior to being executed to handle a pending FPU exception. See the section titled “No-Wait FPU Instructions Can Get FPU Interrupt in Window” in Appendix D of the *Intel® 64 and IA-32 Architectures Software Developer’s Manual, Volume 1*, for a description of these circumstances. An FNSTSW instruction cannot be interrupted in this way on a Pentium 4, Intel Xeon, or P6 family processor.

Operation

DEST ← FPUStatusWord;

FPU Flags Affected

The C0, C1, C2, and C3 are undefined.

Floating-Point Exceptions

None.

Protected Mode Exceptions

#GP(0)	If the destination is located in a non-writable segment. If a memory operand effective address is outside the CS, DS, ES, FS, or GS segment limit. If the DS, ES, FS, or GS register is used to access memory and it contains a NULL segment selector.
#SS(0)	If a memory operand effective address is outside the SS segment limit.
#NM	CR0.EM[bit 2] or CR0.TS[bit 3] = 1.
#PF(fault-code)	If a page fault occurs.
#AC(0)	If alignment checking is enabled and an unaligned memory reference is made while the current privilege level is 3.
#UD	If the LOCK prefix is used.

Real-Address Mode Exceptions

#GP	If a memory operand effective address is outside the CS, DS, ES, FS, or GS segment limit.
#SS	If a memory operand effective address is outside the SS segment limit.
#NM	CR0.EM[bit 2] or CR0.TS[bit 3] = 1.

Virtual-8086 Mode Exceptions

#GP(0)	If a memory operand effective address is outside the CS, DS, ES, FS, or GS segment limit.
#SS(0)	If a memory operand effective address is outside the SS segment limit.
#NM	CR0.EM[bit 2] or CR0.TS[bit 3] = 1.
#PF(fault-code)	If a page fault occurs.
#AC(0)	If alignment checking is enabled and an unaligned memory reference is made.
#UD	If the LOCK prefix is used.

Compatibility Mode Exceptions

Same exceptions as in protected mode.

64-Bit Mode Exceptions

#SS(0)	If a memory address referencing the SS segment is in a non-canonical form.
#GP(0)	If the memory address is in a non-canonical form.
#NM	CR0.EM[bit 2] or CR0.TS[bit 3] = 1.
#MF	If there is a pending x87 FPU exception.
#PF(fault-code)	If a page fault occurs.
#AC(0)	If alignment checking is enabled and an unaligned memory reference is made while the current privilege level is 3.
#UD	If the LOCK prefix is used.

FSUB/FSUBP/FISUB—Subtract

Opcode	Instruction	64-Bit Mode	Compat/Leg Mode	Description
D8 /4	FSUB <i>m32fp</i>	Valid	Valid	Subtract <i>m32fp</i> from ST(0) and store result in ST(0).
DC /4	FSUB <i>m64fp</i>	Valid	Valid	Subtract <i>m64fp</i> from ST(0) and store result in ST(0).
D8 E0+i	FSUB ST(0), ST(i)	Valid	Valid	Subtract ST(i) from ST(0) and store result in ST(0).
DC E8+i	FSUB ST(i), ST(0)	Valid	Valid	Subtract ST(0) from ST(i) and store result in ST(i).
DE E8+i	FSUBP ST(i), ST(0)	Valid	Valid	Subtract ST(0) from ST(i), store result in ST(i), and pop register stack.
DE E9	FSUBP	Valid	Valid	Subtract ST(0) from ST(1), store result in ST(1), and pop register stack.
DA /4	FISUB <i>m32int</i>	Valid	Valid	Subtract <i>m32int</i> from ST(0) and store result in ST(0).
DE /4	FISUB <i>m16int</i>	Valid	Valid	Subtract <i>m16int</i> from ST(0) and store result in ST(0).

Description

Subtracts the source operand from the destination operand and stores the difference in the destination location. The destination operand is always an FPU data register; the source operand can be a register or a memory location. Source operands in memory can be in single-precision or double-precision floating-point format or in word or doubleword integer format.

The no-operand version of the instruction subtracts the contents of the ST(0) register from the ST(1) register and stores the result in ST(1). The one-operand version subtracts the contents of a memory location (either a floating-point or an integer value) from the contents of the ST(0) register and stores the result in ST(0). The two-operand version, subtracts the contents of the ST(0) register from the ST(i) register or vice versa.

The FSUBP instructions perform the additional operation of popping the FPU register stack following the subtraction. To pop the register stack, the processor marks the ST(0) register as empty and increments the stack pointer (TOP) by 1. The no-operand version of the floating-point subtract instructions always results in the register stack being popped. In some assemblers, the mnemonic for this instruction is FSUB rather than FSUBP.

The FISUB instructions convert an integer source operand to double extended-precision floating-point format before performing the subtraction.

Table 3-51 shows the results obtained when subtracting various classes of numbers from one another, assuming that neither overflow nor underflow occurs. Here, the SRC value is subtracted from the DEST value ($\text{DEST} - \text{SRC} = \text{result}$).

When the difference between two operands of like sign is 0, the result is +0, except for the round toward $-\infty$ mode, in which case the result is -0. This instruction also guarantees that $+0 - (-0) = +0$, and that $-0 - (+0) = -0$. When the source operand is an integer 0, it is treated as a +0.

When one operand is ∞ , the result is ∞ of the expected sign. If both operands are ∞ of the same sign, an invalid-operation exception is generated.

Table 3-51. FSUB/FSUBP/FISUB Results

		SRC						
		-•	- F or - I	- 0	+ 0	+ F or + I	+•	
DEST	-•	*	-•	-•	-•	-•	-•	NaN
	- F	+•	$\pm F$ or ± 0	DEST	DEST	- F	-•	NaN
	- 0	+•	-SRC	± 0	- 0	- SRC	-•	NaN
	+ 0	+•	-SRC	+ 0	± 0	- SRC	-•	NaN
	+ F	+•	+ F	DEST	DEST	$\pm F$ or ± 0	-•	NaN
	+•	+•	+•	+•	+•	+•	*	NaN
	NaN	NaN	NaN	NaN	NaN	NaN	NaN	NaN

NOTES:

F Means finite floating-point value.

I Means integer.

* Indicates floating-point invalid-arithmetic-operand (#IA) exception.

This instruction's operation is the same in non-64-bit modes and 64-bit mode.

Operation

IF Instruction = FISUB

THEN

DEST \leftarrow DEST - ConvertToDoubleExtendedPrecisionFP(SRC);

ELSE (* Source operand is floating-point value *)

DEST \leftarrow DEST - SRC;

FI;

```
IF Instruction = FSUBP
    THEN
        PopRegisterStack;
FI;
```

FPU Flags Affected

C1 Set to 0 if stack underflow occurred.
 Set if result was rounded up; cleared otherwise.

C0, C2, C3 Undefined.

Floating-Point Exceptions

#IS Stack underflow occurred.

#IA Operand is an SNaN value or unsupported format.
 Operands are infinities of like sign.

#D Source operand is a denormal value.

#U Result is too small for destination format.

#O Result is too large for destination format.

#P Value cannot be represented exactly in destination format.

Protected Mode Exceptions

#GP(0) If a memory operand effective address is outside the CS, DS, ES, FS, or GS segment limit.
 If the DS, ES, FS, or GS register is used to access memory and it contains a NULL segment selector.

#SS(0) If a memory operand effective address is outside the SS segment limit.

#NM CR0.EM[bit 2] or CR0.TS[bit 3] = 1.

#PF(fault-code) If a page fault occurs.

#AC(0) If alignment checking is enabled and an unaligned memory reference is made while the current privilege level is 3.

#UD If the LOCK prefix is used.

Real-Address Mode Exceptions

#GP If a memory operand effective address is outside the CS, DS, ES, FS, or GS segment limit.

#SS If a memory operand effective address is outside the SS segment limit.

#NM CR0.EM[bit 2] or CR0.TS[bit 3] = 1.

#UD If the LOCK prefix is used.

Virtual-8086 Mode Exceptions

#GP(0)	If a memory operand effective address is outside the CS, DS, ES, FS, or GS segment limit.
#SS(0)	If a memory operand effective address is outside the SS segment limit.
#NM	CR0.EM[bit 2] or CR0.TS[bit 3] = 1.
#PF(fault-code)	If a page fault occurs.
#AC(0)	If alignment checking is enabled and an unaligned memory reference is made.
#UD	If the LOCK prefix is used.

Compatibility Mode Exceptions

Same exceptions as in protected mode.

64-Bit Mode Exceptions

#SS(0)	If a memory address referencing the SS segment is in a non-canonical form.
#GP(0)	If the memory address is in a non-canonical form.
#NM	CR0.EM[bit 2] or CR0.TS[bit 3] = 1.
#MF	If there is a pending x87 FPU exception.
#PF(fault-code)	If a page fault occurs.
#AC(0)	If alignment checking is enabled and an unaligned memory reference is made while the current privilege level is 3.
#UD	If the LOCK prefix is used.

FSUBR/FSUBRP/FISUBR—Reverse Subtract

Opcode	Instruction	64-Bit Mode	Compat/ Leg Mode	Description
D8 /5	FSUBR <i>m32fp</i>	Valid	Valid	Subtract ST(0) from <i>m32fp</i> and store result in ST(0).
DC /5	FSUBR <i>m64fp</i>	Valid	Valid	Subtract ST(0) from <i>m64fp</i> and store result in ST(0).
D8 E8+i	FSUBR ST(0), ST(i)	Valid	Valid	Subtract ST(0) from ST(i) and store result in ST(0).
DC E0+i	FSUBR ST(i), ST(0)	Valid	Valid	Subtract ST(i) from ST(0) and store result in ST(i).
DE E0+i	FSUBRP ST(i), ST(0)	Valid	Valid	Subtract ST(i) from ST(0), store result in ST(i), and pop register stack.
DE E1	FSUBRP	Valid	Valid	Subtract ST(1) from ST(0), store result in ST(1), and pop register stack.
DA /5	FISUBR <i>m32int</i>	Valid	Valid	Subtract ST(0) from <i>m32int</i> and store result in ST(0).
DE /5	FISUBR <i>m16int</i>	Valid	Valid	Subtract ST(0) from <i>m16int</i> and store result in ST(0).

Description

Subtracts the destination operand from the source operand and stores the difference in the destination location. The destination operand is always an FPU register; the source operand can be a register or a memory location. Source operands in memory can be in single-precision or double-precision floating-point format or in word or doubleword integer format.

These instructions perform the reverse operations of the FSUB, FSUBP, and FISUB instructions. They are provided to support more efficient coding.

The no-operand version of the instruction subtracts the contents of the ST(1) register from the ST(0) register and stores the result in ST(1). The one-operand version subtracts the contents of the ST(0) register from the contents of a memory location (either a floating-point or an integer value) and stores the result in ST(0). The two-operand version, subtracts the contents of the ST(i) register from the ST(0) register or vice versa.

The FSUBRP instructions perform the additional operation of popping the FPU register stack following the subtraction. To pop the register stack, the processor marks the ST(0) register as empty and increments the stack pointer (TOP) by 1. The no-operand version of the floating-point reverse subtract instructions always results in

the register stack being popped. In some assemblers, the mnemonic for this instruction is FSUBR rather than FSUBRP.

The FISUBR instructions convert an integer source operand to double extended-precision floating-point format before performing the subtraction.

The following table shows the results obtained when subtracting various classes of numbers from one another, assuming that neither overflow nor underflow occurs. Here, the DEST value is subtracted from the SRC value ($SRC - DEST = \text{result}$).

When the difference between two operands of like sign is 0, the result is +0, except for the round toward $-\infty$ mode, in which case the result is -0. This instruction also guarantees that $+0 - (-0) = +0$, and that $-0 - (+0) = -0$. When the source operand is an integer 0, it is treated as a +0.

When one operand is ∞ , the result is ∞ of the expected sign. If both operands are ∞ of the same sign, an invalid-operation exception is generated.

Table 3-52. FSUBR/FSUBRP/FISUBR Results

		SRC						
		-.	-F or -I	-0	+0	+F or +I	+.	
DEST	-.	*	+.	+.	+.	+.	+.	NaN
	-F	-.	$\pm F$ or ± 0	-DEST	-DEST	+F	+.	NaN
	-0	-.	SRC	± 0	+0	SRC	+.	NaN
	+0	-.	SRC	-0	± 0	SRC	+.	NaN
	+F	-.	-F	-DEST	-DEST	$\pm F$ or ± 0	+.	NaN
	+.	-.	-.	-.	-.	-.	*	NaN
	NaN	NaN	NaN	NaN	NaN	NaN	NaN	NaN

NOTES:

F Means finite floating-point value.

I Means integer.

* Indicates floating-point invalid-arithmic-operand (#IA) exception.

This instruction's operation is the same in non-64-bit modes and 64-bit mode.

Operation

IF Instruction = FISUBR

THEN

DEST \leftarrow ConvertToDoubleExtendedPrecisionFP(SRC) - DEST;

ELSE (* Source operand is floating-point value *)

DEST \leftarrow SRC - DEST; FI;

```
IF Instruction = FSUBRP
  THEN
    PopRegisterStack; FI;
```

FPU Flags Affected

C1 Set to 0 if stack underflow occurred.
 Set if result was rounded up; cleared otherwise.

C0, C2, C3 Undefined.

Floating-Point Exceptions

#IS Stack underflow occurred.

#IA Operand is an SNaN value or unsupported format.
 Operands are infinities of like sign.

#D Source operand is a denormal value.

#U Result is too small for destination format.

#O Result is too large for destination format.

#P Value cannot be represented exactly in destination format.

Protected Mode Exceptions

#GP(0) If a memory operand effective address is outside the CS, DS, ES, FS, or GS segment limit.
 If the DS, ES, FS, or GS register is used to access memory and it contains a NULL segment selector.

#SS(0) If a memory operand effective address is outside the SS segment limit.

#NM CR0.EM[bit 2] or CR0.TS[bit 3] = 1.

#PF(fault-code) If a page fault occurs.

#AC(0) If alignment checking is enabled and an unaligned memory reference is made while the current privilege level is 3.

#UD If the LOCK prefix is used.

Real-Address Mode Exceptions

#GP If a memory operand effective address is outside the CS, DS, ES, FS, or GS segment limit.

#SS If a memory operand effective address is outside the SS segment limit.

#NM CR0.EM[bit 2] or CR0.TS[bit 3] = 1.

#UD If the LOCK prefix is used.

Virtual-8086 Mode Exceptions

#GP(0)	If a memory operand effective address is outside the CS, DS, ES, FS, or GS segment limit.
#SS(0)	If a memory operand effective address is outside the SS segment limit.
#NM	CR0.EM[bit 2] or CR0.TS[bit 3] = 1.
#PF(fault-code)	If a page fault occurs.
#AC(0)	If alignment checking is enabled and an unaligned memory reference is made.
#UD	If the LOCK prefix is used.

Compatibility Mode Exceptions

Same exceptions as in protected mode.

64-Bit Mode Exceptions

#SS(0)	If a memory address referencing the SS segment is in a non-canonical form.
#GP(0)	If the memory address is in a non-canonical form.
#NM	CR0.EM[bit 2] or CR0.TS[bit 3] = 1.
#MF	If there is a pending x87 FPU exception.
#PF(fault-code)	If a page fault occurs.
#AC(0)	If alignment checking is enabled and an unaligned memory reference is made while the current privilege level is 3.
#UD	If the LOCK prefix is used.

FTST—TEST

Opcode	Instruction	64-Bit Mode	Compat/ Leg Mode	Description
D9 E4	FTST	Valid	Valid	Compare ST(0) with 0.0.

Description

Compares the value in the ST(0) register with 0.0 and sets the condition code flags C0, C2, and C3 in the FPU status word according to the results (see table below).

Table 3-53. FTST Results

Condition	C3	C2	C0
ST(0) > 0.0	0	0	0
ST(0) < 0.0	0	0	1
ST(0) = 0.0	1	0	0
Unordered	1	1	1

This instruction performs an “unordered comparison.” An unordered comparison also checks the class of the numbers being compared (see “FXAM—Examine ModR/M” in this chapter). If the value in register ST(0) is a NaN or is in an undefined format, the condition flags are set to “unordered” and the invalid operation exception is generated.

The sign of zero is ignored, so that $(-0.0 \leftarrow +0.0)$.

This instruction’s operation is the same in non-64-bit modes and 64-bit mode.

Operation

CASE (relation of operands) OF

Not comparable: C3, C2, C0 ← 111;

ST(0) > 0.0: C3, C2, C0 ← 000;

ST(0) < 0.0: C3, C2, C0 ← 001;

ST(0) = 0.0: C3, C2, C0 ← 100;

ESAC;

FPU Flags Affected

C1 Set to 0 if stack underflow occurred; otherwise, set to 0.

C0, C2, C3 See Table 3-53.

Floating-Point Exceptions

#IS Stack underflow occurred.

#IA	The source operand is a NaN value or is in an unsupported format.
#D	The source operand is a denormal value.

Protected Mode Exceptions

#NM	CRO.EM[bit 2] or CRO.TS[bit 3] = 1.
#MF	If there is a pending x87 FPU exception.
#UD	If the LOCK prefix is used.

Real-Address Mode Exceptions

Same exceptions as in protected mode.

Virtual-8086 Mode Exceptions

Same exceptions as in protected mode.

Compatibility Mode Exceptions

Same exceptions as in protected mode.

64-Bit Mode Exceptions

Same exceptions as in protected mode.

FUCOM/FUCOMP/FUCOMPP—Unordered Compare Floating Point Values

Opcode	Instruction	64-Bit Mode	Compat/Leg Mode	Description
DD E0+i	FUCOM ST(i)	Valid	Valid	Compare ST(0) with ST(i).
DD E1	FUCOM	Valid	Valid	Compare ST(0) with ST(1).
DD E8+i	FUCOMP ST(i)	Valid	Valid	Compare ST(0) with ST(i) and pop register stack.
DD E9	FUCOMP	Valid	Valid	Compare ST(0) with ST(1) and pop register stack.
DA E9	FUCOMPP	Valid	Valid	Compare ST(0) with ST(1) and pop register stack twice.

Description

Performs an unordered comparison of the contents of register ST(0) and ST(i) and sets condition code flags C0, C2, and C3 in the FPU status word according to the results (see the table below). If no operand is specified, the contents of registers ST(0) and ST(1) are compared. The sign of zero is ignored, so that -0.0 is equal to $+0.0$.

Table 3-54. FUCOM/FUCOMP/FUCOMPP Results

Comparison Results*	C3	C2	C0
ST0 > ST(i)	0	0	0
ST0 < ST(i)	0	0	1
ST0 = ST(i)	1	0	0
Unordered	1	1	1

NOTES:

* Flags not set if unmasked invalid-arithmetic-operand (#IA) exception is generated.

An unordered comparison checks the class of the numbers being compared (see “FXAM—Examine ModR/M” in this chapter). The FUCOM/FUCOMP/FUCOMPP instructions perform the same operations as the FCOM/FCOMP/FCOMPP instructions. The only difference is that the FUCOM/FUCOMP/FUCOMPP instructions raise the invalid-arithmetic-operand exception (#IA) only when either or both operands are an SNaN or are in an unsupported format; QNaNs cause the condition code flags to be set to unordered, but do not cause an exception to be generated. The FCOM/FCOMP/FCOMPP instructions raise an invalid-operation exception when either or both of the operands are a NaN value of any kind or are in an unsupported format.

As with the FCOM/FCOMP/FCOMPP instructions, if the operation results in an invalid-arithmetic-operand exception being raised, the condition code flags are set only if the exception is masked.

The FUCOMP instruction pops the register stack following the comparison operation and the FUCOMPP instruction pops the register stack twice following the comparison operation. To pop the register stack, the processor marks the ST(0) register as empty and increments the stack pointer (TOP) by 1.

This instruction's operation is the same in non-64-bit modes and 64-bit mode.

Operation

CASE (relation of operands) OF

ST > SRC: C3, C2, C0 ← 000;

ST < SRC: C3, C2, C0 ← 001;

ST = SRC: C3, C2, C0 ← 100;

ESAC;

IF ST(0) or SRC = QNaN, but not SNaN or unsupported format

THEN

C3, C2, C0 ← 111;

ELSE (* ST(0) or SRC is SNaN or unsupported format *)

#IA;

IF FPUControlWord.IM = 1

THEN

C3, C2, C0 ← 111;

FI;

FI;

IF Instruction = FUCOMP

THEN

PopRegisterStack;

FI;

IF Instruction = FUCOMPP

THEN

PopRegisterStack;

FI;

FPU Flags Affected

C1 Set to 0 if stack underflow occurred.

C0, C2, C3 See Table 3-54.

Floating-Point Exceptions

#IS Stack underflow occurred.

#IA	One or both operands are SNaN values or have unsupported formats. Detection of a QNaN value in and of itself does not raise an invalid-operand exception.
#D	One or both operands are denormal values.

Protected Mode Exceptions

#NM	CR0.EM[bit 2] or CR0.TS[bit 3] = 1.
#MF	If there is a pending x87 FPU exception.
#UD	If the LOCK prefix is used.

Real-Address Mode Exceptions

Same exceptions as in protected mode.

Virtual-8086 Mode Exceptions

Same exceptions as in protected mode.

Compatibility Mode Exceptions

Same exceptions as in protected mode.

64-Bit Mode Exceptions

Same exceptions as in protected mode.

FXAM—Examine ModR/M

Opcode	Instruction	64-Bit Mode	Compat/ Leg Mode	Description
D9 E5	FXAM	Valid	Valid	Classify value or number in ST(0).

Description

Examines the contents of the ST(0) register and sets the condition code flags C0, C2, and C3 in the FPU status word to indicate the class of value or number in the register (see the table below).

Table 3-55. FXAM Results

Class	C3	C2	C0
Unsupported	0	0	0
NaN	0	0	1
Normal finite number	0	1	0
Infinity	0	1	1
Zero	1	0	0
Empty	1	0	1
Denormal number	1	1	0

The C1 flag is set to the sign of the value in ST(0), regardless of whether the register is empty or full.

This instruction's operation is the same in non-64-bit modes and 64-bit mode.

Operation

C1 ← sign bit of ST; (* 0 for positive, 1 for negative *)

CASE (class of value or number in ST(0)) OF

 Unsupported: C3, C2, C0 ← 000;

 NaN: C3, C2, C0 ← 001;

 Normal: C3, C2, C0 ← 010;

 Infinity: C3, C2, C0 ← 011;

 Zero: C3, C2, C0 ← 100;

 Empty: C3, C2, C0 ← 101;

 Denormal: C3, C2, C0 ← 110;

ESAC;

FPU Flags Affected

C1	Sign of value in ST(0).
C0, C2, C3	See Table 3-55.

Floating-Point Exceptions

None.

Protected Mode Exceptions

#NM	CR0.EM[bit 2] or CR0.TS[bit 3] = 1.
#MF	If there is a pending x87 FPU exception.
#UD	If the LOCK prefix is used.

Real-Address Mode Exceptions

Same exceptions as in protected mode.

Virtual-8086 Mode Exceptions

Same exceptions as in protected mode.

Compatibility Mode Exceptions

Same exceptions as in protected mode.

64-Bit Mode Exceptions

Same exceptions as in protected mode.

FXCH—Exchange Register Contents

Opcode	Instruction	64-Bit Mode	Compat/ Leg Mode	Description
D9 C8+i	FXCH ST(i)	Valid	Valid	Exchange the contents of ST(0) and ST(i).
D9 C9	FXCH	Valid	Valid	Exchange the contents of ST(0) and ST(1).

Description

Exchanges the contents of registers ST(0) and ST(i). If no source operand is specified, the contents of ST(0) and ST(1) are exchanged.

This instruction provides a simple means of moving values in the FPU register stack to the top of the stack [ST(0)], so that they can be operated on by those floating-point instructions that can only operate on values in ST(0). For example, the following instruction sequence takes the square root of the third register from the top of the register stack:

```
FXCH ST(3);
FSQRT;
FXCH ST(3);
```

This instruction's operation is the same in non-64-bit modes and 64-bit mode.

Operation

```
IF (Number-of-operands) is 1
  THEN
    temp ← ST(0);
    ST(0) ← SRC;
    SRC ← temp;
  ELSE
    temp ← ST(0);
    ST(0) ← ST(1);
    ST(1) ← temp;
```

FI;

FPU Flags Affected

C1 Set to 0 if stack underflow occurred; otherwise, set to 1.
 C0, C2, C3 Undefined.

Floating-Point Exceptions

#IS Stack underflow occurred.

Protected Mode Exceptions

#NM	CR0.EM[bit 2] or CR0.TS[bit 3] = 1.
#MF	If there is a pending x87 FPU exception.
#UD	If the LOCK prefix is used.

Real-Address Mode Exceptions

Same exceptions as in protected mode.

Virtual-8086 Mode Exceptions

Same exceptions as in protected mode.

Compatibility Mode Exceptions

Same exceptions as in protected mode.

64-Bit Mode Exceptions

Same exceptions as in protected mode.

FXRSTOR—Restore x87 FPU, MMX , XMM, and MXCSR State

Opcode	Instruction	64-Bit Mode	Compat/Leg Mode	Description
OF AE /1	FXRSTOR <i>m512byte</i>	Valid	Valid	Restore the x87 FPU, MMX, XMM, and MXCSR register state from <i>m512byte</i> .

Description

Reloads the x87 FPU, MMX technology, XMM, and MXCSR registers from the 512-byte memory image specified in the source operand. This data should have been written to memory previously using the FXSAVE instruction, and in the same format as required by the operating modes. The first byte of the data should be located on a 16-byte boundary. There are three distinct layout of the FXSAVE state map: one for legacy and compatibility mode, a second format for 64-bit mode with promoted operand size, and the third format is for 64-bit mode with default operand size. Table 3-56 shows the layout of the legacy/compatibility mode state information in memory and describes the fields in the memory image for the FXRSTOR and FXSAVE instructions. Table 3-59 shows the layout of the 64-bit mode stat information when REX.W is set. Table 3-60 shows the layout of the 64-bit mode stat information when REX.W is clear.

The state image referenced with an FXRSTOR instruction must have been saved using an FXSAVE instruction or be in the same format as required by Table 3-56, Table 3-59, or Table 3-60. Referencing a state image saved with an FSAVE, FNSAVE instruction or incompatible field layout will result in an incorrect state restoration.

The FXRSTOR instruction does not flush pending x87 FPU exceptions. To check and raise exceptions when loading x87 FPU state information with the FXRSTOR instruction, use an FWAIT instruction after the FXRSTOR instruction.

If the OSFXSR bit in control register CR4 is not set, the FXRSTOR instruction may not restore the states of the XMM and MXCSR registers. This behavior is implementation dependent.

If the MXCSR state contains an unmasked exception with a corresponding status flag also set, loading the register with the FXRSTOR instruction will not result in a SIMD floating-point error condition being generated. Only the next occurrence of this unmasked exception will result in the exception being generated.

Bits 16 through 32 of the MXCSR register are defined as reserved and should be set to 0. Attempting to write a 1 in any of these bits from the saved state image will result in a general protection exception (#GP) being generated.

Bytes 464:511 of an FXSAVE image are available for software use. FXRSTOR ignores the content of bytes 464:511 in an FXSAVE state image.

Operation

(x87 FPU, MMX, XMM7-XMM0, MXCSR) ← Load(SRC);

x87 FPU and SIMD Floating-Point Exceptions

None.

Protected Mode Exceptions

#GP(0)	For an illegal memory operand effective address in the CS, DS, ES, FS or GS segments. If a memory operand is not aligned on a 16-byte boundary, regardless of segment. (See alignment check exception [#AC] below.) For an attempt to set reserved bits in MXCSR.
#SS(0)	For an illegal address in the SS segment.
#PF(fault-code)	For a page fault.
#NM	If CR0.TS[bit 3] = 1. If CR0.EM[bit 2] = 1.
#UD	If CPUID.01H: EDX.FXSR[bit 24] = 0. If instruction is preceded by a LOCK prefix.
#AC	If this exception is disabled a general protection exception (#GP) is signaled if the memory operand is not aligned on a 16-byte boundary, as described above. If the alignment check exception (#AC) is enabled (and the CPL is 3), signaling of #AC is not guaranteed and may vary with implementation, as follows. In all implementations where #AC is not signaled, a general protection exception is signaled in its place. In addition, the width of the alignment check may also vary with implementation. For instance, for a given implementation, an alignment check exception might be signaled for a 2-byte misalignment, whereas a general protection exception might be signaled for all other misalignments (4-, 8-, or 16-byte misalignments).
#UD	If the LOCK prefix is used.

Real-Address Mode Exceptions

#GP	If a memory operand is not aligned on a 16-byte boundary, regardless of segment. If any part of the operand lies outside the effective address space from 0 to FFFFH. For an attempt to set reserved bits in MXCSR.
#NM	If CR0.TS[bit 3] = 1. If CR0.EM[bit 2] = 1.

#UD If CPUID.01H: EDX.FXSR[bit 24] = 0.
If the LOCK prefix is used.

Virtual-8086 Mode Exceptions

Same exceptions as in real address mode.

#PF(fault-code) For a page fault.
#AC For unaligned memory reference.
#UD If the LOCK prefix is used.

Compatibility Mode Exceptions

Same exceptions as in protected mode.

64-Bit Mode Exceptions

#SS(0) If a memory address referencing the SS segment is in a non-canonical form.

#GP(0) If the memory address is in a non-canonical form.
If memory operand is not aligned on a 16-byte boundary, regardless of segment.
For an attempt to set reserved bits in MXCSR.

#MF If there is a pending x87 FPU exception.

#PF(fault-code) For a page fault.

#NM If CR0.TS[bit 3] = 1.
If CR0.EM[bit 2] = 1.

#UD If CPUID.01H: EDX.FXSR[bit 24] = 0.
If instruction is preceded by a LOCK prefix.

#AC If this exception is disabled a general protection exception (#GP) is signaled if the memory operand is not aligned on a 16-byte boundary, as described above. If the alignment check exception (#AC) is enabled (and the CPL is 3), signaling of #AC is not guaranteed and may vary with implementation, as follows. In all implementations where #AC is not signaled, a general protection exception is signaled in its place. In addition, the width of the alignment check may also vary with implementation. For instance, for a given implementation, an alignment check exception might be signaled for a 2-byte misalignment, whereas a general protection exception might be signaled for all other misalignments (4-, 8-, or 16-byte misalignments).

FXSAVE—Save x87 FPU, MMX Technology, and SSE State

Opcode	Instruction	64-Bit Mode	Compat/ Leg Mode	Description
OF AE /0	FXSAVE <i>m512byte</i>	Valid	Valid	Save the x87 FPU, MMX, XMM, and MXCSR register state to <i>m512byte</i> .

Description

Saves the current state of the x87 FPU, MMX technology, XMM, and MXCSR registers to a 512-byte memory location specified in the destination operand. The content layout of the 512 byte region depends on whether the processor is operating in non-64-bit operating modes or 64-bit sub-mode of IA-32e mode.

Bytes 464:511 are available to software use. The processor does not write to bytes 464:511 of an FXSAVE area.

The operation of FXSAVE in non-64-bit modes is described first.

Non-64-Bit Mode Operation

Table 3-56 shows the layout of the state information in memory when the processor is operating in legacy modes.

Table 3-56. Non-64-bit-Mode Layout of FXSAVE and FXRSTOR Memory Region

15	14	13	12	11	10	9	8	7	6	5	4	3	2	1	0	
Rsrvd		CS		FPU IP			FOP		FTW		FSW		FCW		0	
MXCSR_MASK			MXCSR			Rsrvd		DS		FPU DP			16			
Reserved						ST0/MM0						32				
Reserved						ST1/MM1						48				
Reserved						ST2/MM2						64				
Reserved						ST3/MM3						80				
Reserved						ST4/MM4						96				
Reserved						ST5/MM5						112				
Reserved						ST6/MM6						128				
Reserved						ST7/MM7						144				
						XMM0						160				
						XMM1						176				
						XMM2						192				

Table 3-56. Non-64-bit-Mode Layout of FXSAVE and FXRSTOR Memory Region (Contd.)

15	14	13	12	11	10	9	8	7	6	5	4	3	2	1	0	
XMM3																208
XMM4																224
XMM5																240
XMM6																256
XMM7																272
Reserved																288
Reserved																304
Reserved																320
Reserved																336
Reserved																352
Reserved																368
Reserved																384
Reserved																400
Reserved																416
Reserved																432
Reserved																448
Available																464
Available																480
Available																496

The destination operand contains the first byte of the memory image, and it must be aligned on a 16-byte boundary. A misaligned destination operand will result in a general-protection (#GP) exception being generated (or in some cases, an alignment check exception [#AC]).

The FXSAVE instruction is used when an operating system needs to perform a context switch or when an exception handler needs to save and examine the current state of the x87 FPU, MMX technology, and/or XMM and MXCSR registers.

The fields in Table 3-56 are defined in Table 3-57.

Table 3-57. Field Definitions

Field	Definition
FCW	x87 FPU Control Word (16 bits). See Figure 8-6 in the <i>Intel® 64 and IA-32 Architectures Software Developer's Manual, Volume 1</i> , for the layout of the x87 FPU control word.
FSW	x87 FPU Status Word (16 bits). See Figure 8-4 in the <i>Intel® 64 and IA-32 Architectures Software Developer's Manual, Volume 1</i> , for the layout of the x87 FPU status word.
FTW	x87 FPU Tag Word (8 bits). The tag information saved here is abridged, as described in the following paragraphs. See Figure 8-7 in the <i>Intel® 64 and IA-32 Architectures Software Developer's Manual, Volume 1</i> , for the layout of the x87 FPU tag word.
FOP	x87 FPU Opcode (16 bits). The lower 11 bits of this field contain the opcode, upper 5 bits are reserved. See Figure 8-8 in the <i>Intel® 64 and IA-32 Architectures Software Developer's Manual, Volume 1</i> , for the layout of the x87 FPU opcode field.
FPU IP	x87 FPU Instruction Pointer Offset (32 bits). The contents of this field differ depending on the current addressing mode (32-bit or 16-bit) of the processor when the FXSAVE instruction was executed: 32-bit mode — 32-bit IP offset. 16-bit mode — low 16 bits are IP offset; high 16 bits are reserved. See “x87 FPU Instruction and Operand (Data) Pointers” in Chapter 8 of the <i>Intel® 64 and IA-32 Architectures Software Developer's Manual, Volume 1</i> , for a description of the x87 FPU instruction pointer.
CS	x87 FPU Instruction Pointer Selector (16 bits).
FPU DP	x87 FPU Instruction Operand (Data) Pointer Offset (32 bits). The contents of this field differ depending on the current addressing mode (32-bit or 16-bit) of the processor when the FXSAVE instruction was executed: 32-bit mode — 32-bit IP offset. 16-bit mode — low 16 bits are IP offset; high 16 bits are reserved.
	See “x87 FPU Instruction and Operand (Data) Pointers” in Chapter 8 of the <i>Intel® 64 and IA-32 Architectures Software Developer's Manual, Volume 1</i> , for a description of the x87 FPU operand pointer.
DS	x87 FPU Instruction Operand (Data) Pointer Selector (16 bits).

Table 3-57. Field Definitions (Contd.)

Field	Definition
MXCSR	MXCSR Register State (32 bits). See Figure 10-3 in the <i>Intel® 64 and IA-32 Architectures Software Developer's Manual, Volume 1</i> , for the layout of the MXCSR register. If the OSFXSR bit in control register CR4 is not set, the FXSAVE instruction may not save this register. This behavior is implementation dependent.
MXCSR_MASK	MXCSR_MASK (32 bits). This mask can be used to adjust values written to the MXCSR register, ensuring that reserved bits are set to 0. Set the mask bits and flags in MXCSR to the mode of operation desired for SSE and SSE2 SIMD floating-point instructions. See "Guidelines for Writing to the MXCSR Register" in Chapter 11 of the <i>Intel® 64 and IA-32 Architectures Software Developer's Manual, Volume 1</i> , for instructions for how to determine and use the MXCSR_MASK value.
ST0/MM0 through ST7/MM7	x87 FPU or MMX technology registers. These 80-bit fields contain the x87 FPU data registers or the MMX technology registers, depending on the state of the processor prior to the execution of the FXSAVE instruction. If the processor had been executing x87 FPU instruction prior to the FXSAVE instruction, the x87 FPU data registers are saved; if it had been executing MMX instructions (or SSE or SSE2 instructions that operated on the MMX technology registers), the MMX technology registers are saved. When the MMX technology registers are saved, the high 16 bits of the field are reserved.
XMM0 through XMM7	XMM registers (128 bits per field). If the OSFXSR bit in control register CR4 is not set, the FXSAVE instruction may not save these registers. This behavior is implementation dependent.

The FXSAVE instruction saves an abridged version of the x87 FPU tag word in the FTW field (unlike the FSAVE instruction, which saves the complete tag word). The tag information is saved in physical register order (R0 through R7), rather than in top-of-stack (TOS) order. With the FXSAVE instruction, however, only a single bit (1 for valid or 0 for empty) is saved for each tag. For example, assume that the tag word is currently set as follows:

```
R7 R6 R5 R4 R3 R2 R1 R0
11 xx xx xx 11 11 11 11
```

Here, 11B indicates empty stack elements and "xx" indicates valid (00B), zero (01B), or special (10B).

For this example, the FXSAVE instruction saves only the following 8 bits of information:

```
R7 R6 R5 R4 R3 R2 R1 R0
0 1 1 1 0 0 0 0
```

Here, a 1 is saved for any valid, zero, or special tag, and a 0 is saved for any empty tag.

The operation of the FXSAVE instruction differs from that of the FSAVE instruction, the as follows:

- FXSAVE instruction does not check for pending unmasked floating-point exceptions. (The FXSAVE operation in this regard is similar to the operation of the FNSAVE instruction).
- After the FXSAVE instruction has saved the state of the x87 FPU, MMX technology, XMM, and MXCSR registers, the processor retains the contents of the registers. Because of this behavior, the FXSAVE instruction cannot be used by an application program to pass a “clean” x87 FPU state to a procedure, since it retains the current state. To clean the x87 FPU state, an application must explicitly execute a FINIT instruction after an FXSAVE instruction to reinitialize the x87 FPU state.
- The format of the memory image saved with the FXSAVE instruction is the same regardless of the current addressing mode (32-bit or 16-bit) and operating mode (protected, real address, or system management). This behavior differs from the FSAVE instructions, where the memory image format is different depending on the addressing mode and operating mode. Because of the different image formats, the memory image saved with the FXSAVE instruction cannot be restored correctly with the FRSTOR instruction, and likewise the state saved with the FSAVE instruction cannot be restored correctly with the FXRSTOR instruction.

The FSAVE format for FTW can be recreated from the FTW valid bits and the stored 80-bit FP data (assuming the stored data was not the contents of MMX technology registers) using Table 3-58.

Table 3-58. Recreating FSAVE Format

Exponent all 1's	Exponent all 0's	Fraction all 0's	J and M bits	FTW valid bit	x87 FTW	
0	0	0	0x	1	Special	10
0	0	0	1x	1	Valid	00
0	0	1	00	1	Special	10
0	0	1	10	1	Valid	00
0	1	0	0x	1	Special	10
0	1	0	1x	1	Special	10
0	1	1	00	1	Zero	01
0	1	1	10	1	Special	10
1	0	0	1x	1	Special	10
1	0	0	1x	1	Special	10

Table 3-58. Recreating FSAVE Format (Contd.)

Exponent all 1's	Exponent all 0's	Fraction all 0's	J and M bits	FTW valid bit	x87 FTW	
1	0	1	00	1	Special	10
1	0	1	10	1	Special	10
For all legal combinations above.				0	Empty	11

The J-bit is defined to be the 1-bit binary integer to the left of the decimal place in the significand. The M-bit is defined to be the most significant bit of the fractional portion of the significand (i.e., the bit immediately to the right of the decimal place).

When the M-bit is the most significant bit of the fractional portion of the significand, it must be 0 if the fraction is all 0's.

IA-32e Mode Operation

In compatibility sub-mode of IA-32e mode, legacy SSE registers, XMM0 through XMM7, are saved according to the legacy FXSAVE map. In 64-bit mode, all of the SSE registers, XMM0 through XMM15, are saved. But the layout of the 64-bit FXSAVE map has two flavors, depending on the value of the REX.W bit. The difference of these two flavors is in the FPU IP and FPU DP pointers. When REX.W = 0, the FPU IP is saved as CS with the 32 bit IP, and the FPU DP is saved as DS with the 32 bit DP. When REX.W = 1, the FPU IP and FPU DP are both 64 bit values without and segment selectors.

The IA-32e mode save formats are shown in Table 3-59 and Table 3-60 listed below.

**Table 3-59. Layout of the 64-bit-mode FXSAVE Map
with Promoted OperandSize**

15	14	13	12	11	10	9	8	7	6	5	4	3	2	1	0	
FPU IP								FOP	FTW			FSW	FCW	0		
MXCSR_MASK				MXCSR				FPU DP								16
Reserved				ST0/MM0												32
Reserved				ST1/MM1												48
Reserved				ST2/MM2												64
Reserved				ST3/MM3												80
Reserved				ST4/MM4												96
Reserved				ST5/MM5												112
Reserved				ST6/MM6												128
Reserved				ST7/MM7												144
										XMM0						160
										XMM1						176

Table 3-59. Layout of the 64-bit-mode FXSAVE Map with Promoted OperandSize (Contd.)

15	14	13	12	11	10	9	8	7	6	5	4	3	2	1	0	
XMM2																192
XMM3																208
XMM4																224
XMM5																240
XMM6																256
XMM7																272
XMM8																288
XMM9																304
XMM10																320
XMM11																336
XMM12																352
XMM13																368
XMM14																384
XMM15																400
Reserved																416
Reserved																432
Reserved																448
Available																464
Available																480
Available																496

Table 3-60. Layout of the 64-bit-mode FXSAVE Map with Default OperandSize

15	14	13	12	11	10	9	8	7	6	5	4	3	2	1	0	
Reserved		CS		FPU IP			FOP		FTW		FSW		FCW		0	
MXCSR_MASK			MXCSR			Re-served		DS		FPU DP				16		
Reserved				ST0/MM0				32								
Reserved				ST1/MM1				48								
Reserved				ST2/MM2				64								
Reserved				ST3/MM3				80								

Table 3-60. Layout of the 64-bit-mode FXSAVE Map with Default OperandSize (Contd.)

15	14	13	12	11	10	9	8	7	6	5	4	3	2	1	0	
Reserved						ST4/MM4										96
Reserved						ST5/MM5										112
Reserved						ST6/MM6										128
Reserved						ST7/MM7										144
						XMM0										160
						XMM1										176
						XMM2										192
						XMM3										208
						XMM4										224
						XMM5										240
						XMM6										256
						XMM7										272
						XMM8										288
						XMM9										304
						XMM10										320
						XMM11										336
						XMM12										352
						XMM13										368
						XMM14										384
						XMM15										400
						Reserved										416
						Reserved										432
						Reserved										448
						Available										464
						Available										480
						Available										496

Operation

IF 64-Bit Mode
 THEN
 IF REX.W = 1

```

THEN
    DEST ← Save64BitPromotedFxsave(x87 FPU, MMX, XMM7-XMM0,
    MXCSR);
ELSE
    DEST ← Save64BitDefaultFxsave(x87 FPU, MMX, XMM7-XMM0, MXCSR);
FI;
ELSE
    DEST ← SaveLegacyFxsave(x87 FPU, MMX, XMM7-XMM0, MXCSR);
FI;

```

Protected Mode Exceptions

#GP(0)	For an illegal memory operand effective address in the CS, DS, ES, FS or GS segments. If a memory operand is not aligned on a 16-byte boundary, regardless of segment. (See the description of the alignment check exception [#AC] below.)
#SS(0)	For an illegal address in the SS segment.
#PF(fault-code)	For a page fault.
#NM	If CRO.TS[bit 3] = 1. If CRO.EM[bit 2] = 1.
#UD	If CPUID.01H:EDX.FXSR[bit 24] = 0.
#UD	If the LOCK prefix is used.
#AC	If this exception is disabled a general protection exception (#GP) is signaled if the memory operand is not aligned on a 16-byte boundary, as described above. If the alignment check exception (#AC) is enabled (and the CPL is 3), signaling of #AC is not guaranteed and may vary with implementation, as follows. In all implementations where #AC is not signaled, a general protection exception is signaled in its place. In addition, the width of the alignment check may also vary with implementation. For instance, for a given implementation, an alignment check exception might be signaled for a 2-byte misalignment, whereas a general protection exception might be signaled for all other misalignments (4-, 8-, or 16-byte misalignments).

Real-Address Mode Exceptions

#GP	If a memory operand is not aligned on a 16-byte boundary, regardless of segment. If any part of the operand lies outside the effective address space from 0 to FFFFH.
#NM	If CRO.TS[bit 3] = 1.

	If CR0.EM[bit 2] = 1.
#UD	If CPUID.01H: EDX.FXSR[bit 24] = 0. If the LOCK prefix is used.

Virtual-8086 Mode Exceptions

Same exceptions as in real address mode.

#PF(fault-code)	For a page fault.
#AC	For unaligned memory reference.
#UD	If the LOCK prefix is used.

Compatibility Mode Exceptions

Same exceptions as in protected mode.

64-Bit Mode Exceptions

#SS(0)	If a memory address referencing the SS segment is in a non-canonical form.
#GP(0)	If the memory address is in a non-canonical form. If memory operand is not aligned on a 16-byte boundary, regardless of segment.
#MF	If there is a pending x87 FPU exception.
#PF(fault-code)	For a page fault.
#NM	If CR0.TS[bit 3] = 1. If CR0.EM[bit 2] = 1.
#UD	If CPUID.01H: EDX.FXSR[bit 24] = 0. If the LOCK prefix is used.
#AC	If this exception is disabled a general protection exception (#GP) is signaled if the memory operand is not aligned on a 16-byte boundary, as described above. If the alignment check exception (#AC) is enabled (and the CPL is 3), signaling of #AC is not guaranteed and may vary with implementation, as follows. In all implementations where #AC is not signaled, a general protection exception is signaled in its place. In addition, the width of the alignment check may also vary with implementation. For instance, for a given implementation, an alignment check exception might be signaled for a 2-byte misalignment, whereas a general protection exception might be signaled for all other misalignments (4-, 8-, or 16-byte misalignments).

Implementation Note

The order in which the processor signals general-protection (#GP) and page-fault (#PF) exceptions when they both occur on an instruction boundary is given in Table 5-2 in the *Intel® 64 and IA-32 Architectures Software Developer's Manual, Volume 3B*. This order vary for FXSAVE for different processor implementations.

FXTRACT—Extract Exponent and Significand

Opcode	Instruction	64-Bit Mode	Compat/ Leg Mode	Description
D9 F4	FXTRACT	Valid	Valid	Separate value in ST(0) into exponent and significand, store exponent in ST(0), and push the significand onto the register stack.

Description

Separates the source value in the ST(0) register into its exponent and significand, stores the exponent in ST(0), and pushes the significand onto the register stack. Following this operation, the new top-of-stack register ST(0) contains the value of the original significand expressed as a floating-point value. The sign and significand of this value are the same as those found in the source operand, and the exponent is 3FFFH (biased value for a true exponent of zero). The ST(1) register contains the value of the original operand's true (unbiased) exponent expressed as a floating-point value. (The operation performed by this instruction is a superset of the IEEE-recommended $\log_b(x)$ function.)

This instruction and the F2XM1 instruction are useful for performing power and range scaling operations. The FXTRACT instruction is also useful for converting numbers in double extended-precision floating-point format to decimal representations (e.g., for printing or displaying).

If the floating-point zero-divide exception (#Z) is masked and the source operand is zero, an exponent value of $-\infty$ is stored in register ST(1) and 0 with the sign of the source operand is stored in register ST(0).

This instruction's operation is the same in non-64-bit modes and 64-bit mode.

Operation

```
TEMP ← Significand(ST(0));
ST(0) ← Exponent(ST(0));
TOP ← TOP - 1;
ST(0) ← TEMP;
```

FPU Flags Affected

C1	Set to 0 if stack underflow occurred; set to 1 if stack overflow occurred.
C0, C2, C3	Undefined.

Floating-Point Exceptions

#IS	Stack underflow or overflow occurred.
-----	---------------------------------------

#IA	Source operand is an SNaN value or unsupported format.
#Z	ST(0) operand is ± 0 .
#D	Source operand is a denormal value.

Protected Mode Exceptions

#NM	CR0.EM[bit 2] or CR0.TS[bit 3] = 1.
#MF	If there is a pending x87 FPU exception.
#UD	If the LOCK prefix is used.

Real-Address Mode Exceptions

Same exceptions as in protected mode.

Virtual-8086 Mode Exceptions

Same exceptions as in protected mode.

Compatibility Mode Exceptions

Same exceptions as in protected mode.

64-Bit Mode Exceptions

Same exceptions as in protected mode.

FYL2X—Compute $y * \log_2 x$

Opcode	Instruction	64-Bit Mode	Compat/ Leg Mode	Description
D9 F1	FYL2X	Valid	Valid	Replace ST(1) with $(ST(1) * \log_2 ST(0))$ and pop the register stack.

Description

Computes $(ST(1) * \log_2 (ST(0)))$, stores the result in register ST(1), and pops the FPU register stack. The source operand in ST(0) must be a non-zero positive number.

The following table shows the results obtained when taking the log of various classes of numbers, assuming that neither overflow nor underflow occurs.

Table 3-61. FYL2X Results

		ST(0)							
		-•	-F	±0	+0<+F<+1	+ 1	+ F > + 1	+•	NaN
ST(1)	-•	*	*	+•	+•	*	-•	-•	NaN
	-F	*	*	**	+ F	- 0	- F	-•	NaN
	-0	*	*	*	+ 0	- 0	- 0	*	NaN
	+0	*	*	*	- 0	+ 0	+ 0	*	NaN
	+F	*	*	**	- F	+ 0	+ F	+•	NaN
	+•	*	*	-•	-•	*	+•	+•	NaN
	NaN	NaN	NaN	NaN	NaN	NaN	NaN	NaN	NaN

NOTES:

F Means finite floating-point value.

* Indicates floating-point invalid-operation (#IA) exception.

** Indicates floating-point zero-divide (#Z) exception.

If the divide-by-zero exception is masked and register ST(0) contains ± 0 , the instruction returns ∞ with a sign that is the opposite of the sign of the source operand in register ST(1).

The FYL2X instruction is designed with a built-in multiplication to optimize the calculation of logarithms with an arbitrary positive base (b):

$$\log_b x \leftarrow (\log_2 b)^{-1} * \log_2 x$$

This instruction's operation is the same in non-64-bit modes and 64-bit mode.

Operation

$ST(1) \leftarrow ST(1) * \log_2 ST(0);$
 PopRegisterStack;

FPU Flags Affected

C1 Set to 0 if stack underflow occurred.
 Set if result was rounded up; cleared otherwise.
 C0, C2, C3 Undefined.

Floating-Point Exceptions

#IS Stack underflow occurred.
 #IA Either operand is an SNaN or unsupported format.
 Source operand in register ST(0) is a negative finite value
 (not -0).
 #Z Source operand in register ST(0) is ± 0 .
 #D Source operand is a denormal value.
 #U Result is too small for destination format.
 #O Result is too large for destination format.
 #P Value cannot be represented exactly in destination format.

Protected Mode Exceptions

#NM CR0.EM[bit 2] or CR0.TS[bit 3] = 1.
 #MF If there is a pending x87 FPU exception.
 #UD If the LOCK prefix is used.

Real-Address Mode Exceptions

Same exceptions as in protected mode.

Virtual-8086 Mode Exceptions

Same exceptions as in protected mode.

Compatibility Mode Exceptions

Same exceptions as in protected mode.

64-Bit Mode Exceptions

Same exceptions as in protected mode.

FYL2XP1—Compute $y * \log_2(x + 1)$

Opcode	Instruction	64-Bit Mode	Compat/ Leg Mode	Description
D9 F9	FYL2XP1	Valid	Valid	Replace ST(1) with $ST(1) * \log_2(ST(0) + 1.0)$ and pop the register stack.

Description

Computes $(ST(1) * \log_2(ST(0) + 1.0))$, stores the result in register ST(1), and pops the FPU register stack. The source operand in ST(0) must be in the range:

$$-(1 - \sqrt{2}/2) \text{ to } (1 - \sqrt{2}/2)$$

The source operand in ST(1) can range from $-\infty$ to $+\infty$. If the ST(0) operand is outside of its acceptable range, the result is undefined and software should not rely on an exception being generated. Under some circumstances exceptions may be generated when ST(0) is out of range, but this behavior is implementation specific and not guaranteed.

The following table shows the results obtained when taking the log epsilon of various classes of numbers, assuming that underflow does not occur.

Table 3-62. FYL2XP1 Results

		ST(0)				
		$-(1 - (\sqrt{2}/2))$ to -0	-0	$+0$	$+0$ to $+(1 - (\sqrt{2}/2))$	NaN
ST(1)	$-\bullet$	$+\bullet$	*	*	$-\bullet$	NaN
	$-F$	$+F$	$+0$	-0	$-F$	NaN
	-0	$+0$	$+0$	-0	-0	NaN
	$+0$	-0	-0	$+0$	$+0$	NaN
	$+F$	$-F$	-0	$+0$	$+F$	NaN
	$+\bullet$	$-\bullet$	*	*	$+\bullet$	NaN
	NaN	NaN	NaN	NaN	NaN	NaN

NOTES:

F Means finite floating-point value.

* Indicates floating-point invalid-operation (#IA) exception.

This instruction provides optimal accuracy for values of epsilon [the value in register ST(0)] that are close to 0. For small epsilon (ϵ) values, more significant digits can be retained by using the FYL2XP1 instruction than by using $(\epsilon+1)$ as an argument to the FYL2X instruction. The $(\epsilon+1)$ expression is commonly found in compound interest and annuity calculations. The result can be simply converted into a value in another logarithm base by including a scale factor in the ST(1) source operand. The following

equation is used to calculate the scale factor for a particular logarithm base, where n is the logarithm base desired for the result of the FYL2XP1 instruction:

$$\text{scale factor} \leftarrow \log_n 2$$

This instruction's operation is the same in non-64-bit modes and 64-bit mode.

Operation

$ST(1) \leftarrow ST(1) * \log_2(ST(0) + 1.0);$
PopRegisterStack;

FPU Flags Affected

C1	Set to 0 if stack underflow occurred.
	Set if result was rounded up; cleared otherwise.
C0, C2, C3	Undefined.

Floating-Point Exceptions

#IS	Stack underflow occurred.
#IA	Either operand is an SNaN value or unsupported format.
#D	Source operand is a denormal value.
#U	Result is too small for destination format.
#O	Result is too large for destination format.
#P	Value cannot be represented exactly in destination format.

Protected Mode Exceptions

#NM	CR0.EM[bit 2] or CR0.TS[bit 3] = 1.
#MF	If there is a pending x87 FPU exception.
#UD	If the LOCK prefix is used.

Real-Address Mode Exceptions

Same exceptions as in protected mode.

Virtual-8086 Mode Exceptions

Same exceptions as in protected mode.

Compatibility Mode Exceptions

Same exceptions as in protected mode.

64-Bit Mode Exceptions

Same exceptions as in protected mode.

HADDPD—Packed Double-FP Horizontal Add

Opcode	Instruction	64-Bit Mode	Compat/ Leg Mode	Description
66 0F 7C /r	HADDPD <i>xmm1</i> , <i>xmm2/m128</i>	Valid	Valid	Horizontal add packed double-precision floating-point values from <i>xmm2/m128</i> to <i>xmm1</i> .

Description

Adds the double-precision floating-point values in the high and low quadwords of the destination operand and stores the result in the low quadword of the destination operand.

Adds the double-precision floating-point values in the high and low quadwords of the source operand and stores the result in the high quadword of the destination operand. See Figure 3-11.

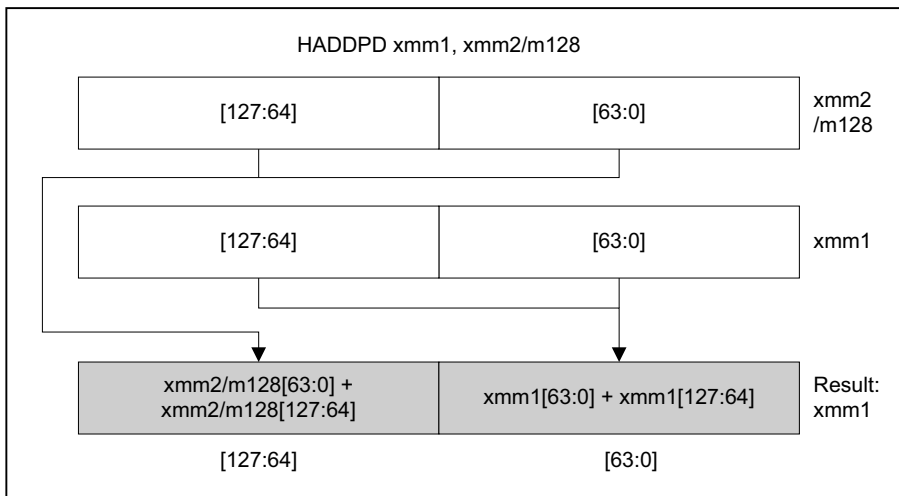

OM15993

Figure 3-11. HADDPD—Packed Double-FP Horizontal Add

In 64-bit mode, use of the REX.R prefix permits this instruction to access additional registers (XMM8-XMM15).

Operation

$xmm1[63:0] = xmm1[63:0] + xmm1[127:64];$
 $xmm1[127:64] = xmm2/m128[63:0] + xmm2/m128[127:64];$

Intel C/C++ Compiler Intrinsic Equivalent

HADDPD `__m128d _mm_hadd_pd(__m128d a, __m128d b)`

Exceptions

When the source operand is a memory operand, the operand must be aligned on a 16-byte boundary or a general-protection exception (#GP) will be generated.

Numeric Exceptions

Overflow, Underflow, Invalid, Precision, Denormal.

Protected Mode Exceptions

#GP(0)	For an illegal memory operand effective address in the CS, DS, ES, FS or GS segments. If a memory operand is not aligned on a 16-byte boundary, regardless of segment.
#SS(0)	For an illegal address in the SS segment.
#PF(fault-code)	For a page fault.
#NM	If CR0.TS[bit 3] = 1.
#XM	For an unmasked Streaming SIMD Extensions numeric exception (CR4.OSXMMEXCPT[bit 10] = 1).
#UD	If CR0.EM[bit 2] = 1. For an unmasked Streaming SIMD Extensions numeric exception (CR4.OSXMMEXCPT[bit 10] = 0). If CR4.OSFXSR[bit 9] = 0. If CPUID.01H: ECX.SSE3[bit 0] = 0. If the LOCK prefix is used.

Real Address Mode Exceptions

GP(0)	If any part of the operand would lie outside of the effective address space from 0 to 0FFFFH. If a memory operand is not aligned on a 16-byte boundary, regardless of segment.
#NM	If CR0.TS[bit 3] = 1.
#XM	For an unmasked Streaming SIMD Extensions numeric exception (CR4.OSXMMEXCPT[bit 10] = 1).

#UD	<p>If CR0.EM[bit 2] = 1.</p> <p>For an unmasked Streaming SIMD Extensions numeric exception (CR4.OSXMMEXCPT[bit 10] = 0).</p> <p>If CR4.OSFXSR[bit 9] = 0.</p> <p>If CPUID.01H: ECX.SSE3[bit 0] = 0.</p> <p>If the LOCK prefix is used.</p>
-----	---------------------------------------------------------------------------------------------------------------------------------------------------------------------------------------------------------------------------------------------

Virtual 8086 Mode Exceptions

GP(0)	<p>If any part of the operand would lie outside of the effective address space from 0 to 0FFFFH.</p> <p>If a memory operand is not aligned on a 16-byte boundary, regardless of segment.</p>
#NM	If CR0.TS[bit 3] = 1.
#XM	For an unmasked Streaming SIMD Extensions numeric exception (CR4.OSXMMEXCPT[bit 10] = 1).
#UD	<p>If CR0.EM[bit 2] = 1.</p> <p>For an unmasked Streaming SIMD Extensions numeric exception (CR4.OSXMMEXCPT[bit 10] = 0).</p> <p>If CR4.OSFXSR[bit 9] = 0.</p> <p>If CPUID.01H: ECX.SSE3[bit 0] = 0.</p> <p>If the LOCK prefix is used.</p>
#PF(fault-code)	For a page fault.

Compatibility Mode Exceptions

Same exceptions as in protected mode.

64-Bit Mode Exceptions

#SS(0)	If a memory address referencing the SS segment is in a non-canonical form.
#GP(0)	<p>If the memory address is in a non-canonical form.</p> <p>If memory operand is not aligned on a 16-byte boundary, regardless of segment.</p>
#PF(fault-code)	For a page fault.
#NM	If CR0.TS[bit 3] = 1.
#XM	If an unmasked SIMD floating-point exception and CR4.OSXMMEXCPT[bit 10] = 1.

#UD

If an unmasked SIMD floating-point exception and CR4.OSXMMEXCPT[bit 10] = 0.
If CR0.EM[bit 2] = 1.
If CR4.OSFXSR[bit 9] = 0.
If CPUID feature flag SSE3 is 0.
If the LOCK prefix is used.

HADDPS—Packed Single-FP Horizontal Add

Opcode	Instruction	64-Bit Mode	Compat/ Leg Mode	Description
F2 0F 7C /r	HADDPS <i>xmm1</i> , <i>xmm2/m128</i>	Valid	Valid	Horizontal add packed single-precision floating-point values from <i>xmm2/m128</i> to <i>xmm1</i> .

Description

Adds the single-precision floating-point values in the first and second dwords of the destination operand and stores the result in the first dword of the destination operand.

Adds single-precision floating-point values in the third and fourth dword of the destination operand and stores the result in the second dword of the destination operand.

Adds single-precision floating-point values in the first and second dword of the source operand and stores the result in the third dword of the destination operand.

Adds single-precision floating-point values in the third and fourth dword of the source operand and stores the result in the fourth dword of the destination operand. See Figure 3-12.

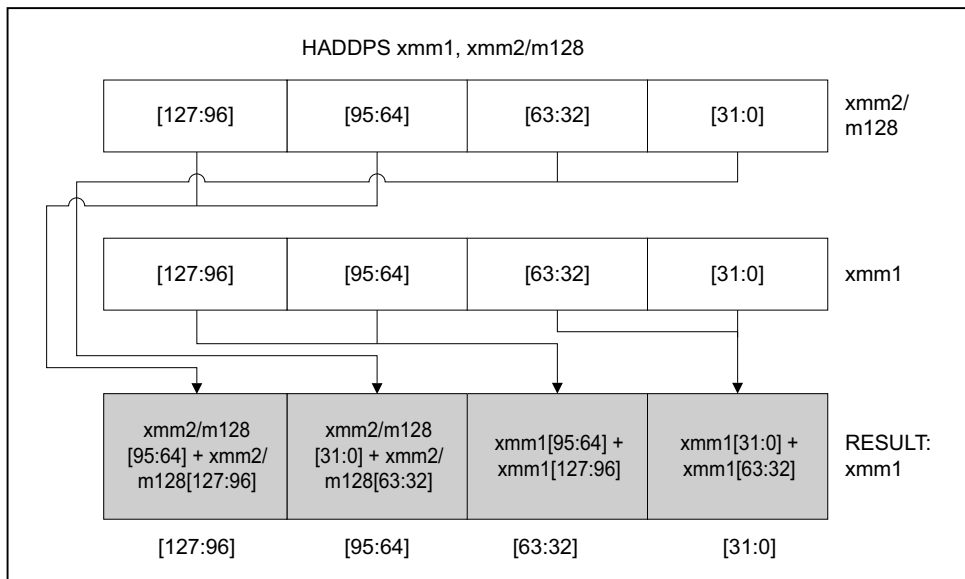

OM15994

Figure 3-12. HADDPS—Packed Single-FP Horizontal Add

In 64-bit mode, use of the REX.R prefix permits this instruction to access additional registers (XMM8-XMM15).

Operation

```
xmm1[31:0] = xmm1[31:0] + xmm1[63:32];
xmm1[63:32] = xmm1[95:64] + xmm1[127:96];
xmm1[95:64] = xmm2/m128[31:0] + xmm2/m128[63:32];
xmm1[127:96] = xmm2/m128[95:64] + xmm2/m128[127:96];
```

Intel C/C++ Compiler Intrinsic Equivalent

```
HADDPS   __m128 _mm_hadd_ps(__m128 a, __m128 b)
```

Exceptions

When the source operand is a memory operand, the operand must be aligned on a 16-byte boundary or a general-protection exception (#GP) will be generated.

Numeric Exceptions

Overflow, Underflow, Invalid, Precision, Denormal.

Protected Mode Exceptions

#GP(0)	For an illegal memory operand effective address in the CS, DS, ES, FS or GS segments. If a memory operand is not aligned on a 16-byte boundary, regardless of segment.
#SS(0)	For an illegal address in the SS segment.
#PF(fault-code)	For a page fault.
#NM	If CR0.TS[bit 3] = 1.
#XM	For an unmasked Streaming SIMD Extensions numeric exception (CR4.OSXMMEXCPT[bit 10] = 1).
#UD	If CR0.EM[bit 2] = 1. For an unmasked Streaming SIMD Extensions numeric exception (CR4.OSXMMEXCPT[bit 10] = 0). If CR4.OSFXSR[bit 9] = 0. If CPUID.01H: ECX.SSE3[bit 0] = 0. If the LOCK prefix is used.

Real Address Mode Exceptions

GP(0)	<p>If any part of the operand would lie outside of the effective address space from 0 to 0FFFFH.</p> <p>If a memory operand is not aligned on a 16-byte boundary, regardless of segment.</p>
#NM	If CR0.TS[bit 3] = 1.
#XM	For an unmasked Streaming SIMD Extensions numeric exception (CR4.OSXMMEXCPT[bit 10] = 1).
#UD	<p>If CR0.EM[bit 2] = 1.</p> <p>For an unmasked Streaming SIMD Extensions numeric exception (CR4.OSXMMEXCPT[bit 10] = 0).</p> <p>If CR4.OSFXSR[bit 9] = 0.</p> <p>If CPUID.01H: ECX.SSE3[bit 0] = 0.</p> <p>If the LOCK prefix is used.</p>

Virtual 8086 Mode Exceptions

GP(0)	<p>If any part of the operand would lie outside of the effective address space from 0 to 0FFFFH.</p> <p>If a memory operand is not aligned on a 16-byte boundary, regardless of segment.</p>
#NM	If CR0.TS[bit 3] = 1.
#XM	For an unmasked Streaming SIMD Extensions numeric exception (CR4.OSXMMEXCPT[bit 10] = 1).
#UD	<p>If CR0.EM[bit 2] = 1.</p> <p>For an unmasked Streaming SIMD Extensions numeric exception (CR4.OSXMMEXCPT[bit 10] = 0).</p> <p>If CR4.OSFXSR[bit 9] = 0.</p> <p>If CPUID.01H: ECX.SSE3[bit 0] = 0.</p> <p>If the LOCK prefix is used.</p>
#PF(fault-code)	For a page fault.

Compatibility Mode Exceptions

Same exceptions as in protected mode.

64-Bit Mode Exceptions

#SS(0)	If a memory address referencing the SS segment is in a non-canonical form.
#GP(0)	<p>If the memory address is in a non-canonical form.</p> <p>If memory operand is not aligned on a 16-byte boundary, regardless of segment.</p>

#PF(fault-code)	For a page fault.
#NM	If CR0.TS[bit 3] = 1.
#XM	If an unmasked SIMD floating-point exception and CR4.OSXMMEXCPT[bit 10] = 1.
#UD	If an unmasked SIMD floating-point exception and CR4.OSXMMEXCPT[bit 10] = 0. If CR0.EM[bit 2] = 1. If CR4.OSFXSR[bit 9] = 0. If CPUID feature flag SSE3 is 0. If the LOCK prefix is used.

HLT—Halt

Opcode	Instruction	64-Bit Mode	Compat/ Leg Mode	Description
F4	HLT	Valid	Valid	Halt

Description

Stops instruction execution and places the processor in a HALT state. An enabled interrupt (including NMI and SMI), a debug exception, the BINIT# signal, the INIT# signal, or the RESET# signal will resume execution. If an interrupt (including NMI) is used to resume execution after a HLT instruction, the saved instruction pointer (CS:EIP) points to the instruction following the HLT instruction.

When a HLT instruction is executed on an Intel 64 or IA-32 processor supporting Intel Hyper-Threading Technology, only the logical processor that executes the instruction is halted. The other logical processors in the physical processor remain active, unless they are each individually halted by executing a HLT instruction.

The HLT instruction is a privileged instruction. When the processor is running in protected or virtual-8086 mode, the privilege level of a program or procedure must be 0 to execute the HLT instruction.

This instruction's operation is the same in non-64-bit modes and 64-bit mode.

Operation

Enter Halt state;

Flags Affected

None.

Protected Mode Exceptions

#GP(0) If the current privilege level is not 0.

#UD If the LOCK prefix is used.

Real-Address Mode Exceptions

None.

Virtual-8086 Mode Exceptions

Same exceptions as in protected mode.

Compatibility Mode Exceptions

Same exceptions as in protected mode.

64-Bit Mode Exceptions

Same exceptions as in protected mode.

HSUBPD—Packed Double-FP Horizontal Subtract

Opcode	Instruction	64-Bit Mode	Compat/ Leg Mode	Description
66 0F 7D /r	HSUBPD <i>xmm1</i> , <i>xmm2/m128</i>	Valid	Valid	Horizontal subtract packed double-precision floating-point values from <i>xmm2/m128</i> to <i>xmm1</i> .

Description

The HSUBPD instruction subtracts horizontally the packed DP FP numbers of both operands.

Subtracts the double-precision floating-point value in the high quadword of the destination operand from the low quadword of the destination operand and stores the result in the low quadword of the destination operand.

Subtracts the double-precision floating-point value in the high quadword of the source operand from the low quadword of the source operand and stores the result in the high quadword of the destination operand. See Figure 3-13.

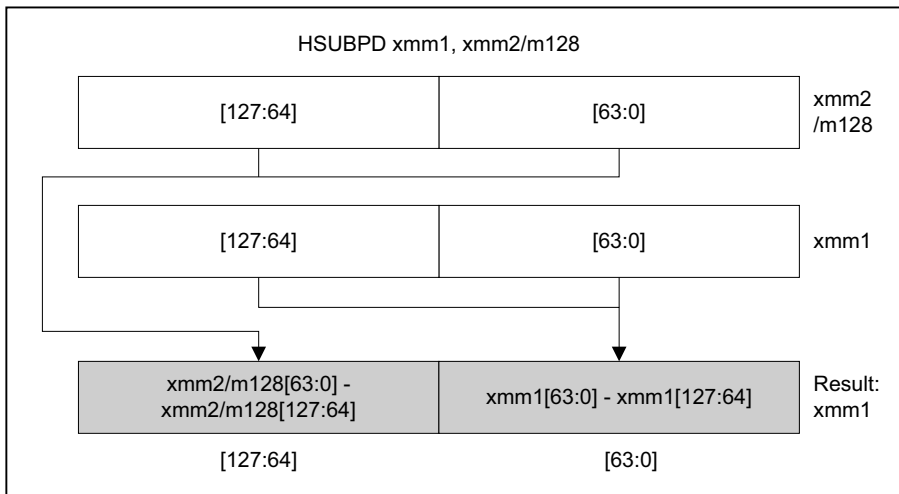

OM15995

Figure 3-13. HSUBPD—Packed Double-FP Horizontal Subtract

In 64-bit mode, use of the REX.R prefix permits this instruction to access additional registers (XMM8-XMM15).

Operation

$xmm1[63:0] = xmm1[63:0] - xmm1[127:64];$
 $xmm1[127:64] = xmm2/m128[63:0] - xmm2/m128[127:64];$

Intel C/C++ Compiler Intrinsic Equivalent

HSUBPD `__m128d _mm_hsub_pd(__m128d a, __m128d b)`

Exceptions

When the source operand is a memory operand, the operand must be aligned on a 16-byte boundary or a general-protection exception (#GP) will be generated.

Numeric Exceptions

Overflow, Underflow, Invalid, Precision, Denormal.

Protected Mode Exceptions

#GP(0)	For an illegal memory operand effective address in the CS, DS, ES, FS or GS segments. If a memory operand is not aligned on a 16-byte boundary, regardless of segment.
#SS(0)	For an illegal address in the SS segment.
#PF(fault-code)	For a page fault.
#NM	If CR0.TS[bit 3] = 1.
#XM	For an unmasked Streaming SIMD Extensions numeric exception (CR4.OSXMMEXCPT[bit 10] = 1).
#UD	If CR0.EM[bit 2] = 1. For an unmasked Streaming SIMD Extensions numeric exception (CR4.OSXMMEXCPT[bit 10] = 0). If CR4.OSFXSR[bit 9] = 0. If CPUID.01H: ECX.SSE3[bit 0] = 0. If the LOCK prefix is used.

Real Address Mode Exceptions

GP(0)	If any part of the operand would lie outside of the effective address space from 0 to 0FFFFH. If a memory operand is not aligned on a 16-byte boundary, regardless of segment.
#NM	If CR0.TS[bit 3] = 1.
#XM	For an unmasked Streaming SIMD Extensions numeric exception (CR4.OSXMMEXCPT[bit 10] = 1).

#UD	<p>If CR0.EM[bit 2] = 1.</p> <p>For an unmasked Streaming SIMD Extensions numeric exception (CR4.OSXMMEXCPT[bit 10] = 0).</p> <p>If CR4.OSFXSR[bit 9] = 0.</p> <p>If CPUID.01H: ECX.SSE3[bit 0] = 0.</p> <p>If the LOCK prefix is used.</p>
-----	---------------------------------------------------------------------------------------------------------------------------------------------------------------------------------------------------------------------------------------------

Virtual 8086 Mode Exceptions

GP(0)	<p>If any part of the operand would lie outside of the effective address space from 0 to 0FFFFH.</p> <p>If a memory operand is not aligned on a 16-byte boundary, regardless of segment.</p>
#NM	If CR0.TS[bit 3] = 1.
#XM	For an unmasked Streaming SIMD Extensions numeric exception (CR4.OSXMMEXCPT[bit 10] = 1).
#UD	<p>If CR0.EM[bit 2] = 1.</p> <p>For an unmasked Streaming SIMD Extensions numeric exception (CR4.OSXMMEXCPT[bit 10] = 0).</p> <p>If CR4.OSFXSR[bit 9] = 0.</p> <p>If CPUID.01H: ECX.SSE3[bit 0] = 0.</p> <p>If the LOCK prefix is used.</p>
#PF(fault-code)	For a page fault.

Compatibility Mode Exceptions

Same exceptions as in protected mode.

64-Bit Mode Exceptions

#SS(0)	If a memory address referencing the SS segment is in a non-canonical form.
#GP(0)	<p>If the memory address is in a non-canonical form.</p> <p>If memory operand is not aligned on a 16-byte boundary, regardless of segment.</p>
#PF(fault-code)	For a page fault.
#NM	If CR0.TS[bit 3] = 1.
#XM	If an unmasked SIMD floating-point exception and CR4.OSXMMEXCPT[bit 10] = 1.
#UD	<p>If an unmasked SIMD floating-point exception and CR4.OSXMMEXCPT[bit 10] = 0.</p> <p>If CR0.EM[bit 2] = 1.</p> <p>If CR4.OSFXSR[bit 9] = 0.</p>

If CPUID feature flag SSE3 is 0.
If the LOCK prefix is used.

HSUBPS—Packed Single-FP Horizontal Subtract

Opcode	Instruction	64-Bit Mode	Compat/ Leg Mode	Description
F2 0F 7D /r	HSUBPS <i>xmm1</i> , <i>xmm2/m128</i>	Valid	Valid	Horizontal subtract packed single-precision floating-point values from <i>xmm2/m128</i> to <i>xmm1</i> .

Description

Subtracts the single-precision floating-point value in the second dword of the destination operand from the first dword of the destination operand and stores the result in the first dword of the destination operand.

Subtracts the single-precision floating-point value in the fourth dword of the destination operand from the third dword of the destination operand and stores the result in the second dword of the destination operand.

Subtracts the single-precision floating-point value in the second dword of the source operand from the first dword of the source operand and stores the result in the third dword of the destination operand.

Subtracts the single-precision floating-point value in the fourth dword of the source operand from the third dword of the source operand and stores the result in the fourth dword of the destination operand.

See Figure 3-14.

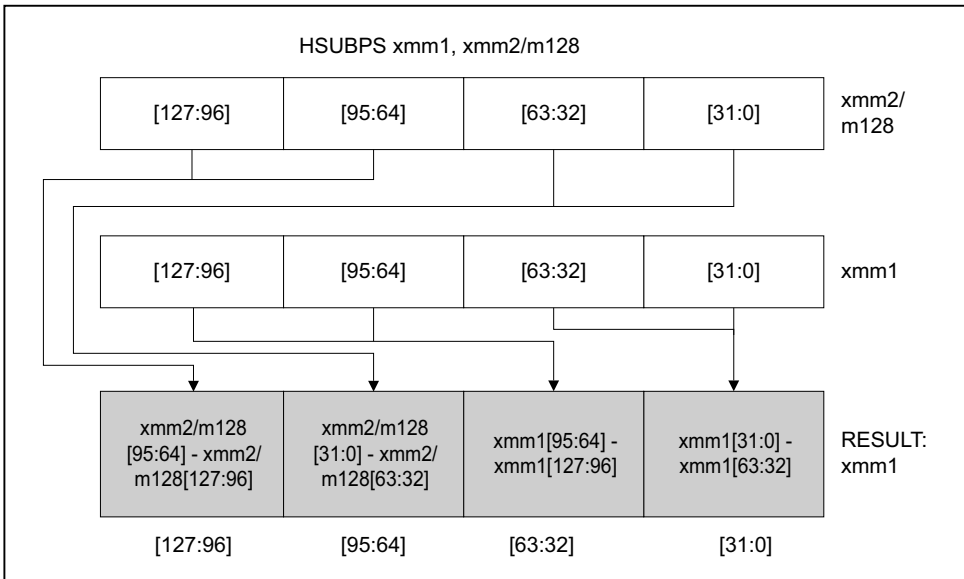

OM15996

Figure 3-14. HSUBPS—Packed Single-FP Horizontal Subtract

In 64-bit mode, use of the REX.R prefix permits this instruction to access additional registers (XMM8-XMM15).

Operation

```

xmm1[31:0] = xmm1[31:0] - xmm1[63:32];
xmm1[63:32] = xmm1[95:64] - xmm1[127:96];
xmm1[95:64] = xmm2/m128[31:0] - xmm2/m128[63:32];
xmm1[127:96] = xmm2/m128[95:64] - xmm2/m128[127:96];

```

Intel C/C++ Compiler Intrinsic Equivalent

```
HSUBPS __m128 _mm_hsub_ps(__m128 a, __m128 b)
```

Exceptions

When the source operand is a memory operand, the operand must be aligned on a 16-byte boundary or a general-protection exception (#GP) will be generated.

Numeric Exceptions

Overflow, Underflow, Invalid, Precision, Denormal.

Protected Mode Exceptions

#GP(0)	For an illegal memory operand effective address in the CS, DS, ES, FS or GS segments. If a memory operand is not aligned on a 16-byte boundary, regardless of segment.
#SS(0)	For an illegal address in the SS segment.
#PF(fault-code)	For a page fault.
#NM	If CR0.TS[bit 3] = 1.
#XM	For an unmasked Streaming SIMD Extensions numeric exception (CR4.OSXMMEXCPT[bit 10] = 1).
#UD	If CR0.EM[bit 2] = 1. For an unmasked Streaming SIMD Extensions numeric exception (CR4.OSXMMEXCPT[bit 10] = 0). If CR4.OSFXSR[bit 9] = 0. If CPUID.01H: ECX.SSE3[bit 0] = 0. If the LOCK prefix is used.

Real Address Mode Exceptions

GP(0)	If any part of the operand would lie outside of the effective address space from 0 to 0FFFFH. If a memory operand is not aligned on a 16-byte boundary, regardless of segment.
#NM	If CR0.TS[bit 3] = 1.
#XM	For an unmasked Streaming SIMD Extensions numeric exception (CR4.OSXMMEXCPT[bit 10] = 1).
#UD	If CR0.EM[bit 2] = 1. For an unmasked Streaming SIMD Extensions numeric exception (CR4.OSXMMEXCPT[bit 10] = 0). If CR4.OSFXSR[bit 9] = 0. If CPUID.01H: ECX.SSE3[bit 0] = 0. If the LOCK prefix is used.

Virtual 8086 Mode Exceptions

GP(0)	If any part of the operand would lie outside of the effective address space from 0 to 0FFFFH. If a memory operand is not aligned on a 16-byte boundary, regardless of segment.
-------	-----------------------------------------------------------------------------------------------------------------------------------------------------------------------------------

#NM	If CR0.TS[bit 3] = 1.
#XM	For an unmasked Streaming SIMD Extensions numeric exception (CR4.OSXMMEXCPT[bit 10] = 1).
#UD	If CR0.EM[bit 2] = 1. For an unmasked Streaming SIMD Extensions numeric exception (CR4.OSXMMEXCPT[bit 10] = 0). If CR4.OSFXSR[bit 9] = 0. If the LOCK prefix is used. If CPUID.01H: ECX.SSE3[bit 0] = 0.
#PF(fault-code)	For a page fault.

Compatibility Mode Exceptions

Same exceptions as in protected mode.

64-Bit Mode Exceptions

#SS(0)	If a memory address referencing the SS segment is in a non-canonical form.
#GP(0)	If the memory address is in a non-canonical form. If memory operand is not aligned on a 16-byte boundary, regardless of segment.
#PF(fault-code)	For a page fault.
#NM	If CR0.TS[bit 3] = 1.
#XM	If an unmasked SIMD floating-point exception and CR4.OSXMMEXCPT[bit 10] = 1.
#UD	If an unmasked SIMD floating-point exception and CR4.OSXMMEXCPT[bit 10] = 0. If CR0.EM[bit 2] = 1. If CR4.OSFXSR[bit 9] = 0. If CPUID.01H: ECX.SSE3[bit 0] = 0. If the LOCK prefix is used.

IDIV—Signed Divide

Opcode	Instruction	64-Bit Mode	Compat/Leg Mode	Description
F6 /7	IDIV <i>r/m8</i>	Valid	Valid	Signed divide AX by <i>r/m8</i> , with result stored in: AL ← Quotient, AH ← Remainder.
REX + F6 /7	IDIV <i>r/m8</i> *	Valid	N.E.	Signed divide AX by <i>r/m8</i> , with result stored in: AL ← Quotient, AH ← Remainder.
F7 /7	IDIV <i>r/m16</i>	Valid	Valid	Signed divide DX:AX by <i>r/m16</i> , with result stored in: AX ← Quotient, DX ← Remainder.
F7 /7	IDIV <i>r/m32</i>	Valid	Valid	Signed divide EDX:EAX by <i>r/m32</i> , with result stored in: EAX ← Quotient, EDX ← Remainder.
REX.W + F7 /7	IDIV <i>r/m64</i>	Valid	N.E.	Signed divide RDX:RAX by <i>r/m64</i> , with result stored in: RAX ← Quotient, RDX ← Remainder.

NOTES:

- * In 64-bit mode, *r/m8* can not be encoded to access the following byte registers if a REX prefix is used: AH, BH, CH, DH.

Description

Divides the (signed) value in the AX, DX:AX, or EDX:EAX (dividend) by the source operand (divisor) and stores the result in the AX (AH:AL), DX:AX, or EDX:EAX registers. The source operand can be a general-purpose register or a memory location. The action of this instruction depends on the operand size (dividend/divisor).

Non-integral results are truncated (chopped) towards 0. The remainder is always less than the divisor in magnitude. Overflow is indicated with the #DE (divide error) exception rather than with the CF flag.

In 64-bit mode, the instruction's default operation size is 32 bits. Use of the REX.R prefix permits access to additional registers (R8-R15). Use of the REX.W prefix promotes operation to 64 bits. In 64-bit mode when REX.W is applied, the instruction divides the signed value in RDX:RAX by the source operand. RAX contains a 64-bit quotient; RDX contains a 64-bit remainder.

See the summary chart at the beginning of this section for encoding data and limits. See Table 3-63.

Table 3-63. IDIV Results

Operand Size	Dividend	Divisor	Quotient	Remainder	Quotient Range
Word/byte	AX	r/m8	AL	AH	-128 to +127
Doubleword/word	DX:AX	r/m16	AX	DX	-32,768 to +32,767
Quadword/doubleword	EDX:EAX	r/m32	EAX	EDX	-2^{31} to $2^{32} - 1$
Doublequadword/ quadword	RDX:RAX	r/m64	RAX	RDX	-2^{63} to $2^{64} - 1$

Operation

IF SRC = 0

THEN #DE; (* Divide error *)

FI;

IF OperandSize = 8 (* Word/byte operation *)

THEN

temp ← AX / SRC; (* Signed division *)

IF (temp > 7FH) or (temp < 80H)

(* If a positive result is greater than 7FH or a negative result is less than 80H *)

THEN #DE; (* Divide error *)

ELSE

AL ← temp;

AH ← AX SignedModulus SRC;

FI;

ELSE IF OperandSize = 16 (* Doubleword/word operation *)

THEN

temp ← DX:AX / SRC; (* Signed division *)

IF (temp > 7FFFH) or (temp < 8000H)

(* If a positive result is greater than 7FFFH
or a negative result is less than 8000H *)

THEN

#DE; (* Divide error *)

ELSE

AX ← temp;

DX ← DX:AX SignedModulus SRC;

FI;

FI;

ELSE IF OperandSize = 32 (* Quadword/doubleword operation *)

temp ← EDX:EAX / SRC; (* Signed division *)

IF (temp > 7FFFFFFFFH) or (temp < 80000000H)

(* If a positive result is greater than 7FFFFFFFFH

```

    or a negative result is less than 80000000H *)
    THEN
        #DE; (* Divide error *)
    ELSE
        EAX ← temp;
        EDX ← EDXE:AX SignedModulus SRC;
    FI;
FI;
ELSE IF OperandSize = 64 (* Doublequadword/quadword operation *)
    temp ← RDX:RAX / SRC; (* Signed division *)
    IF (temp > 7FFFFFFFFFH) or (temp < 8000000000000000H)
        (* If a positive result is greater than 7FFFFFFFFFH
        or a negative result is less than 8000000000000000H *)
        THEN
            #DE; (* Divide error *)
        ELSE
            RAX ← temp;
            RDX ← RDE:RAX SignedModulus SRC;
        FI;
    FI;
FI;

```

Flags Affected

The CF, OF, SF, ZF, AF, and PF flags are undefined.

Protected Mode Exceptions

#DE	If the source operand (divisor) is 0. The signed result (quotient) is too large for the destination.
#GP(0)	If a memory operand effective address is outside the CS, DS, ES, FS, or GS segment limit. If the DS, ES, FS, or GS register is used to access memory and it contains a NULL segment selector.
#SS(0)	If a memory operand effective address is outside the SS segment limit.
#PF(fault-code)	If a page fault occurs.
#AC(0)	If alignment checking is enabled and an unaligned memory reference is made while the current privilege level is 3.
#UD	If the LOCK prefix is used.

Real-Address Mode Exceptions

#DE	If the source operand (divisor) is 0. The signed result (quotient) is too large for the destination.
#GP	If a memory operand effective address is outside the CS, DS, ES, FS, or GS segment limit.
#SS	If a memory operand effective address is outside the SS segment limit.
#UD	If the LOCK prefix is used.

Virtual-8086 Mode Exceptions

#DE	If the source operand (divisor) is 0. The signed result (quotient) is too large for the destination.
#GP(0)	If a memory operand effective address is outside the CS, DS, ES, FS, or GS segment limit.
#SS(0)	If a memory operand effective address is outside the SS segment limit.
#PF(fault-code)	If a page fault occurs.
#AC(0)	If alignment checking is enabled and an unaligned memory reference is made.
#UD	If the LOCK prefix is used.

Compatibility Mode Exceptions

Same exceptions as in protected mode.

64-Bit Mode Exceptions

#SS(0)	If a memory address referencing the SS segment is in a non-canonical form.
#GP(0)	If the memory address is in a non-canonical form.
#DE	If the source operand (divisor) is 0 If the quotient is too large for the designated register.
#PF(fault-code)	If a page fault occurs.
#AC(0)	If alignment checking is enabled and an unaligned memory reference is made while the current privilege level is 3.
#UD	If the LOCK prefix is used.

IMUL—Signed Multiply

Opcode	Instruction	64-Bit Mode	Compat/ Leg Mode	Description
F6 /5	IMUL <i>r/m8*</i>	Valid	Valid	AX ← AL * <i>r/m</i> byte.
F7 /5	IMUL <i>r/m16</i>	Valid	Valid	DX:AX ← AX * <i>r/m</i> word.
F7 /5	IMUL <i>r/m32</i>	Valid	Valid	EDX:EAX ← EAX * <i>r/m32</i> .
REX.W + F7 /5	IMUL <i>r/m64</i>	Valid	N.E.	RDX:RAX ← RAX * <i>r/m64</i> .
0F AF /r	IMUL <i>r16, r/m16</i>	Valid	Valid	word register ← word register * <i>r/m16</i> .
0F AF /r	IMUL <i>r32, r/m32</i>	Valid	Valid	doubleword register ← doubleword register * <i>r/m32</i> .
REX.W + 0F AF /r	IMUL <i>r64, r/m64</i>	Valid	N.E.	Quadword register ← Quadword register * <i>r/m64</i> .
6B /r ib	IMUL <i>r16, r/m16, imm8</i>	Valid	Valid	word register ← <i>r/m16</i> * sign-extended immediate byte.
6B /r ib	IMUL <i>r32, r/m32, imm8</i>	Valid	Valid	doubleword register ← <i>r/m32</i> * sign-extended immediate byte.
REX.W + 6B /r ib	IMUL <i>r64, r/m64, imm8</i>	Valid	N.E.	Quadword register ← <i>r/m64</i> * sign-extended immediate byte.
6B /r ib	IMUL <i>r16, imm8</i>	Valid	Valid	word register ← word register * sign-extended immediate byte.
6B /r ib	IMUL <i>r32, imm8</i>	Valid	Valid	doubleword register ← doubleword register * sign-extended immediate byte.
REX.W + 6B /r ib	IMUL <i>r64, imm8</i>	Valid	N.E.	Quadword register ← Quadword register * sign-extended immediate byte.
69 /r iw	IMUL <i>r16, r/m16, imm16</i>	Valid	Valid	word register ← <i>r/m16</i> * immediate word.
69 /r id	IMUL <i>r32, r/m32, imm32</i>	Valid	Valid	doubleword register ← <i>r/m32</i> * immediate doubleword.
REX.W + 69 /r id	IMUL <i>r64, r/m64, imm32</i>	Valid	N.E.	Quadword register ← <i>r/m64</i> * immediate doubleword.
69 /r iw	IMUL <i>r16, imm16</i>	Valid	Valid	word register ← <i>r/m16</i> * immediate word.

Opcode	Instruction	64-Bit Mode	Compat/Leg Mode	Description
69 <i>r id</i>	IMUL <i>r32, imm32</i>	Valid	Valid	doubleword register ← <i>r/m32</i> * immediate doubleword.
REX.W + 69 <i>r id</i>	IMUL <i>r64, imm32</i>	Valid	N.E.	Quadword register ← <i>r/m64</i> * immediate doubleword.

NOTES:

- * In 64-bit mode, *r/m8* can not be encoded to access the following byte registers if a REX prefix is used: AH, BH, CH, DH.

Description

Performs a signed multiplication of two operands. This instruction has three forms, depending on the number of operands.

- **One-operand form** — This form is identical to that used by the MUL instruction. Here, the source operand (in a general-purpose register or memory location) is multiplied by the value in the AL, AX, EAX, or RAX register (depending on the operand size) and the product is stored in the AX, DX:AX, EDX:EAX, or RDX:RAX registers, respectively.
- **Two-operand form** — With this form the destination operand (the first operand) is multiplied by the source operand (second operand). The destination operand is a general-purpose register and the source operand is an immediate value, a general-purpose register, or a memory location. The product is then stored in the destination operand location.
- **Three-operand form** — This form requires a destination operand (the first operand) and two source operands (the second and the third operands). Here, the first source operand (which can be a general-purpose register or a memory location) is multiplied by the second source operand (an immediate value). The product is then stored in the destination operand (a general-purpose register).

When an immediate value is used as an operand, it is sign-extended to the length of the destination operand format.

The CF and OF flags are set when significant bit (including the sign bit) are carried into the upper half of the result. The CF and OF flags are cleared when the result (including the sign bit) fits exactly in the lower half of the result.

The three forms of the IMUL instruction are similar in that the length of the product is calculated to twice the length of the operands. With the one-operand form, the product is stored exactly in the destination. With the two- and three- operand forms, however, the result is truncated to the length of the destination before it is stored in the destination register. Because of this truncation, the CF or OF flag should be tested to ensure that no significant bits are lost.

The two- and three-operand forms may also be used with unsigned operands because the lower half of the product is the same regardless if the operands are

signed or unsigned. The CF and OF flags, however, cannot be used to determine if the upper half of the result is non-zero.

In 64-bit mode, the instruction's default operation size is 32 bits. Use of the REX.R prefix permits access to additional registers (R8-R15). Use of the REX.W prefix promotes operation to 64 bits. Use of REX.W modifies the three forms of the instruction as follows.

- **One-operand form** —The source operand (in a 64-bit general-purpose register or memory location) is multiplied by the value in the RAX register and the product is stored in the RDX:RAX registers.
- **Two-operand form** — The source operand is promoted to 64 bits if it is a register or a memory location. If the source operand is an immediate, it is sign extended to 64 bits. The destination operand is promoted to 64 bits.
- **Three-operand form** — The first source operand (either a register or a memory location) and destination operand are promoted to 64 bits.

Operation

```

IF (NumberOfOperands = 1)
  THEN IF (OperandSize = 8)
    THEN
      AX ← AL * SRC (* Signed multiplication *)
      IF AL = AX
        THEN CF ← 0; OF ← 0;
        ELSE CF ← 1; OF ← 1; FI;
    ELSE IF OperandSize = 16
      THEN
        DX:AX ← AX * SRC (* Signed multiplication *)
        IF sign_extend_to_32 (AX) = DX:AX
          THEN CF ← 0; OF ← 0;
          ELSE CF ← 1; OF ← 1; FI;
    ELSE IF OperandSize = 32
      THEN
        EDX:EAX ← EAX * SRC (* Signed multiplication *)
        IF EAX = EDX:EAX
          THEN CF ← 0; OF ← 0;
          ELSE CF ← 1; OF ← 1; FI;
    ELSE (* OperandSize = 64 *)
      RDX:RAX ← RAX * SRC (* Signed multiplication *)
      IF RAX = RDX:RAX
        THEN CF ← 0; OF ← 0;
        ELSE CF ← 1; OF ← 1; FI;
    FI;
  FI;

```

```

ELSE IF (NumberOfOperands = 2)
    THEN
        temp ← DEST * SRC (* Signed multiplication; temp is double DEST size *)
        DEST ← DEST * SRC (* Signed multiplication *)
        IF temp ≠ DEST
            THEN CF ← 1; OF ← 1;
            ELSE CF ← 0; OF ← 0; FI;
ELSE (* NumberOfOperands = 3 *)
    DEST ← SRC1 * SRC2 (* Signed multiplication *)
    temp ← SRC1 * SRC2 (* Signed multiplication; temp is double SRC1 size *)
    IF temp ≠ DEST
        THEN CF ← 1; OF ← 1;
        ELSE CF ← 0; OF ← 0; FI;
FI;
FI;

```

Flags Affected

For the one operand form of the instruction, the CF and OF flags are set when significant bits are carried into the upper half of the result and cleared when the result fits exactly in the lower half of the result. For the two- and three-operand forms of the instruction, the CF and OF flags are set when the result must be truncated to fit in the destination operand size and cleared when the result fits exactly in the destination operand size. The SF, ZF, AF, and PF flags are undefined.

Protected Mode Exceptions

#GP(0)	If a memory operand effective address is outside the CS, DS, ES, FS, or GS segment limit. If the DS, ES, FS, or GS register is used to access memory and it contains a NULL NULL segment selector.
#SS(0)	If a memory operand effective address is outside the SS segment limit.
#PF(fault-code)	If a page fault occurs.
#AC(0)	If alignment checking is enabled and an unaligned memory reference is made while the current privilege level is 3.
#UD	If the LOCK prefix is used.

Real-Address Mode Exceptions

#GP	If a memory operand effective address is outside the CS, DS, ES, FS, or GS segment limit.
-----	-------------------------------------------------------------------------------------------

#SS	If a memory operand effective address is outside the SS segment limit.
#UD	If the LOCK prefix is used.

Virtual-8086 Mode Exceptions

#GP(0)	If a memory operand effective address is outside the CS, DS, ES, FS, or GS segment limit.
#SS(0)	If a memory operand effective address is outside the SS segment limit.
#PF(fault-code)	If a page fault occurs.
#AC(0)	If alignment checking is enabled and an unaligned memory reference is made.
#UD	If the LOCK prefix is used.

Compatibility Mode Exceptions

Same exceptions as in protected mode.

64-Bit Mode Exceptions

#SS(0)	If a memory address referencing the SS segment is in a non-canonical form.
#GP(0)	If the memory address is in a non-canonical form.
#PF(fault-code)	If a page fault occurs.
#AC(0)	If alignment checking is enabled and an unaligned memory reference is made while the current privilege level is 3.
#UD	If the LOCK prefix is used.

IN—Input from Port

Opcode	Instruction	64-Bit Mode	Compat/Leg Mode	Description
E4 <i>ib</i>	IN AL, <i>imm8</i>	Valid	Valid	Input byte from <i>imm8</i> I/O port address into AL.
E5 <i>ib</i>	IN AX, <i>imm8</i>	Valid	Valid	Input word from <i>imm8</i> I/O port address into AX.
E5 <i>ib</i>	IN EAX, <i>imm8</i>	Valid	Valid	Input dword from <i>imm8</i> I/O port address into EAX.
EC	IN AL,DX	Valid	Valid	Input byte from I/O port in DX into AL.
ED	IN AX,DX	Valid	Valid	Input word from I/O port in DX into AX.
ED	IN EAX,DX	Valid	Valid	Input doubleword from I/O port in DX into EAX.

Description

Copies the value from the I/O port specified with the second operand (source operand) to the destination operand (first operand). The source operand can be a byte-immediate or the DX register; the destination operand can be register AL, AX, or EAX, depending on the size of the port being accessed (8, 16, or 32 bits, respectively). Using the DX register as a source operand allows I/O port addresses from 0 to 65,535 to be accessed; using a byte immediate allows I/O port addresses 0 to 255 to be accessed.

When accessing an 8-bit I/O port, the opcode determines the port size; when accessing a 16- and 32-bit I/O port, the operand-size attribute determines the port size. At the machine code level, I/O instructions are shorter when accessing 8-bit I/O ports. Here, the upper eight bits of the port address will be 0.

This instruction is only useful for accessing I/O ports located in the processor's I/O address space. See Chapter 13, "Input/Output," in the *Intel® 64 and IA-32 Architectures Software Developer's Manual, Volume 1*, for more information on accessing I/O ports in the I/O address space.

This instruction's operation is the same in non-64-bit modes and 64-bit mode.

Operation

```
IF ((PE = 1) and ((CPL > IOPL) or (VM = 1)))
  THEN (* Protected mode with CPL > IOPL or virtual-8086 mode *)
    IF (Any I/O Permission Bit for I/O port being accessed = 1)
      THEN (* I/O operation is not allowed *)
        #GP(0);
      ELSE (* I/O operation is allowed *)
```

```

        DEST ← SRC; (* Read from selected I/O port *)
FI;
ELSE (Real Mode or Protected Mode with CPL ≤ IOPL *)
    DEST ← SRC; (* Read from selected I/O port *)
FI;

```

Flags Affected

None.

Protected Mode Exceptions

#GP(0) If the CPL is greater than (has less privilege) the I/O privilege level (IOPL) and any of the corresponding I/O permission bits in TSS for the I/O port being accessed is 1.

#UD If the LOCK prefix is used.

Real-Address Mode Exceptions

#UD If the LOCK prefix is used.

Virtual-8086 Mode Exceptions

#GP(0) If any of the I/O permission bits in the TSS for the I/O port being accessed is 1.

#PF(fault-code) If a page fault occurs.

#UD If the LOCK prefix is used.

Compatibility Mode Exceptions

Same exceptions as in protected mode.

64-Bit Mode Exceptions

#GP(0) If the CPL is greater than (has less privilege) the I/O privilege level (IOPL) and any of the corresponding I/O permission bits in TSS for the I/O port being accessed is 1.

#UD If the LOCK prefix is used.

INC—Increment by 1

Opcode	Instruction	64-Bit Mode	Compat/ Leg Mode	Description
FE /0	INC <i>r/m8</i>	Valid	Valid	Increment <i>r/m</i> byte by 1.
REX + FE /0	INC <i>r/m8</i> *	Valid	N.E.	Increment <i>r/m</i> byte by 1.
FF /0	INC <i>r/m16</i>	Valid	Valid	Increment <i>r/m</i> word by 1.
FF /0	INC <i>r/m32</i>	Valid	Valid	Increment <i>r/m</i> doubleword by 1.
REX.W + FF /0	INC <i>r/m64</i>	Valid	N.E.	Increment <i>r/m</i> quadword by 1.
40+ <i>rw</i> **	INC <i>r16</i>	N.E.	Valid	Increment word register by 1.
40+ <i>rd</i>	INC <i>r32</i>	N.E.	Valid	Increment doubleword register by 1.

NOTES:

* In 64-bit mode, *r/m8* can not be encoded to access the following byte registers if a REX prefix is used: AH, BH, CH, DH.

** 40H through 47H are REX prefixes in 64-bit mode.

Description

Adds 1 to the destination operand, while preserving the state of the CF flag. The destination operand can be a register or a memory location. This instruction allows a loop counter to be updated without disturbing the CF flag. (Use a ADD instruction with an immediate operand of 1 to perform an increment operation that does updates the CF flag.)

This instruction can be used with a LOCK prefix to allow the instruction to be executed atomically.

In 64-bit mode, INC *r16* and INC *r32* are not encodable (because opcodes 40H through 47H are REX prefixes). Otherwise, the instruction's 64-bit mode default operation size is 32 bits. Use of the REX.R prefix permits access to additional registers (R8-R15). Use of the REX.W prefix promotes operation to 64 bits.

Operation

DEST ← DEST + 1;

AFlags Affected

The CF flag is not affected. The OF, SF, ZF, AF, and PF flags are set according to the result.

Protected Mode Exceptions

#GP(0)	If the destination operand is located in a non-writable segment. If a memory operand effective address is outside the CS, DS, ES, FS, or GS segment limit. If the DS, ES, FS, or GS register is used to access memory and it contains a NULLsegment selector.
#SS(0)	If a memory operand effective address is outside the SS segment limit.
#PF(fault-code)	If a page fault occurs.
#AC(0)	If alignment checking is enabled and an unaligned memory reference is made while the current privilege level is 3.
#UD	If the LOCK prefix is used but the destination is not a memory operand.

Real-Address Mode Exceptions

#GP	If a memory operand effective address is outside the CS, DS, ES, FS, or GS segment limit.
#SS	If a memory operand effective address is outside the SS segment limit.
#UD	If the LOCK prefix is used but the destination is not a memory operand.

Virtual-8086 Mode Exceptions

#GP(0)	If a memory operand effective address is outside the CS, DS, ES, FS, or GS segment limit.
#SS(0)	If a memory operand effective address is outside the SS segment limit.
#PF(fault-code)	If a page fault occurs.
#AC(0)	If alignment checking is enabled and an unaligned memory reference is made.
#UD	If the LOCK prefix is used but the destination is not a memory operand.

Compatibility Mode Exceptions

Same exceptions as in protected mode.

64-Bit Mode Exceptions

#SS(0)	If a memory address referencing the SS segment is in a non-canonical form.
#GP(0)	If the memory address is in a non-canonical form.
#PF(fault-code)	If a page fault occurs.

INSTRUCTION SET REFERENCE, A-M

#AC(0)	If alignment checking is enabled and an unaligned memory reference is made while the current privilege level is 3.
#UD	If the LOCK prefix is used but the destination is not a memory operand.

INS/INSB/INSW/INSD—Input from Port to String

Opcode	Instruction	64-Bit Mode	Compat/Leg Mode	Description
6C	INS <i>m8</i> , DX	Valid	Valid	Input byte from I/O port specified in DX into memory location specified in ES:(E)DI or RDI.*
6D	INS <i>m16</i> , DX	Valid	Valid	Input word from I/O port specified in DX into memory location specified in ES:(E)DI or RDI. ¹
6D	INS <i>m32</i> , DX	Valid	Valid	Input doubleword from I/O port specified in DX into memory location specified in ES:(E)DI or RDI. ¹
6C	INSB	Valid	Valid	Input byte from I/O port specified in DX into memory location specified with ES:(E)DI or RDI. ¹
6D	INSW	Valid	Valid	Input word from I/O port specified in DX into memory location specified in ES:(E)DI or RDI. ¹
6D	INSD	Valid	Valid	Input doubleword from I/O port specified in DX into memory location specified in ES:(E)DI or RDI. ¹

NOTES:

* In 64-bit mode, only 64-bit (RDI) and 32-bit (EDI) address sizes are supported. In non-64-bit mode, only 32-bit (EDI) and 16-bit (DI) address sizes are supported.

Description

Copies the data from the I/O port specified with the source operand (second operand) to the destination operand (first operand). The source operand is an I/O port address (from 0 to 65,535) that is read from the DX register. The destination operand is a memory location, the address of which is read from either the ES:DI, ES:EDI or the RDI registers (depending on the address-size attribute of the instruction, 16, 32 or 64, respectively). (The ES segment cannot be overridden with a segment override prefix.) The size of the I/O port being accessed (that is, the size of the source and destination operands) is determined by the opcode for an 8-bit I/O port or by the operand-size attribute of the instruction for a 16- or 32-bit I/O port.

At the assembly-code level, two forms of this instruction are allowed: the “explicit-operands” form and the “no-operands” form. The explicit-operands form (specified with the INS mnemonic) allows the source and destination operands to be specified explicitly. Here, the source operand must be “DX,” and the destination operand should be a symbol that indicates the size of the I/O port and the destination address. This explicit-operands form is provided to allow documentation; however, note that the documentation provided by this form can be misleading. That is, the

destination operand symbol must specify the correct **type** (size) of the operand (byte, word, or doubleword), but it does not have to specify the correct **location**. The location is always specified by the ES: (E)DI registers, which must be loaded correctly before the INS instruction is executed.

The no-operands form provides “short forms” of the byte, word, and doubleword versions of the INS instructions. Here also DX is assumed by the processor to be the source operand and ES: (E)DI is assumed to be the destination operand. The size of the I/O port is specified with the choice of mnemonic: INSB (byte), INSW (word), or INSD (doubleword).

After the byte, word, or doubleword is transfer from the I/O port to the memory location, the DI/EDI/RDI register is incremented or decremented automatically according to the setting of the DF flag in the EFLAGS register. (If the DF flag is 0, the (E)DI register is incremented; if the DF flag is 1, the (E)DI register is decremented.) The (E)DI register is incremented or decremented by 1 for byte operations, by 2 for word operations, or by 4 for doubleword operations.

The INS, INSB, INSW, and INSD instructions can be preceded by the REP prefix for block input of ECX bytes, words, or doublewords. See “RDTSCP—Read Time-Stamp Counter and Processor ID” in *Intel® 64 and IA-32 Architectures Software Developer’s Manual, Volume 2B*, for a description of the REP prefix.

These instructions are only useful for accessing I/O ports located in the processor’s I/O address space. See Chapter 13, “Input/Output,” in the *Intel® 64 and IA-32 Architectures Software Developer’s Manual, Volume 1*, for more information on accessing I/O ports in the I/O address space.

In 64-bit mode, default address size is 64 bits, 32 bit address size is supported using the prefix 67H. The address of the memory destination is specified by RDI or EDI. 16-bit address size is not supported in 64-bit mode. The operand size is not promoted.

Operation

```
IF ((PE = 1) and ((CPL > IOPL) or (VM = 1)))
  THEN (* Protected mode with CPL > IOPL or virtual-8086 mode *)
    IF (Any I/O Permission Bit for I/O port being accessed = 1)
      THEN (* I/O operation is not allowed *)
        #GP(0);
      ELSE (* I/O operation is allowed *)
        DEST ← SRC; (* Read from I/O port *)
    FI;
  ELSE (Real Mode or Protected Mode with CPL IOPL *)
    DEST ← SRC; (* Read from I/O port *)
  FI;
```

Non-64-bit Mode:

```

IF (Byte transfer)
  THEN IF DF = 0
    THEN (E)DI ← (E)DI + 1;
    ELSE (E)DI ← (E)DI - 1; FI;
  ELSE IF (Word transfer)
    THEN IF DF = 0
      THEN (E)DI ← (E)DI + 2;
      ELSE (E)DI ← (E)DI - 2; FI;
    ELSE (* Doubleword transfer *)
      THEN IF DF = 0
        THEN (E)DI ← (E)DI + 4;
        ELSE (E)DI ← (E)DI - 4; FI;
    FI;
  FI;

```

FI64-bit Mode:

```

IF (Byte transfer)
  THEN IF DF = 0
    THEN (E|R)DI ← (E|R)DI + 1;
    ELSE (E|R)DI ← (E|R)DI - 1; FI;
  ELSE IF (Word transfer)
    THEN IF DF = 0
      THEN (E)DI ← (E)DI + 2;
      ELSE (E)DI ← (E)DI - 2; FI;
    ELSE (* Doubleword transfer *)
      THEN IF DF = 0
        THEN (E|R)DI ← (E|R)DI + 4;
        ELSE (E|R)DI ← (E|R)DI - 4; FI;
      FI;
    FI;
  FI;

```

Flags Affected

None.

Protected Mode Exceptions

- | | |
|-----------------|-------------------------------------------------------------------------------------------------------------------------------------------------------------------------------------------------------------------------------------------------------------------------------------------------------------------------|
| #GP(0) | If the CPL is greater than (has less privilege) the I/O privilege level (IOPL) and any of the corresponding I/O permission bits in TSS for the I/O port being accessed is 1.
If the destination is located in a non-writable segment.
If an illegal memory operand effective address in the ES segments is given. |
| #PF(fault-code) | If a page fault occurs. |

- #AC(0) If alignment checking is enabled and an unaligned memory reference is made while the current privilege level is 3.
- #UD If the LOCK prefix is used.

Real-Address Mode Exceptions

- #GP If a memory operand effective address is outside the CS, DS, ES, FS, or GS segment limit.
- #SS If a memory operand effective address is outside the SS segment limit.
- #UD If the LOCK prefix is used.

Virtual-8086 Mode Exceptions

- #GP(0) If any of the I/O permission bits in the TSS for the I/O port being accessed is 1.
- #PF(fault-code) If a page fault occurs.
- #AC(0) If alignment checking is enabled and an unaligned memory reference is made.
- #UD If the LOCK prefix is used.

Compatibility Mode Exceptions

Same exceptions as in protected mode.

64-Bit Mode Exceptions

- #SS(0) If a memory address referencing the SS segment is in a non-canonical form.
- #GP(0) If the CPL is greater than (has less privilege) the I/O privilege level (IOPL) and any of the corresponding I/O permission bits in TSS for the I/O port being accessed is 1.
If the memory address is in a non-canonical form.
- #PF(fault-code) If a page fault occurs.
- #AC(0) If alignment checking is enabled and an unaligned memory reference is made while the current privilege level is 3.
- #UD If the LOCK prefix is used.

INSERTPS — Insert Packed Single Precision Floating-Point Value

Opcode	Instruction	64-bit Mode	Compat/ Leg Mode	Description
66 OF 3A 21 /r ib	INSERTPS <i>xmm1</i> , <i>xmm2/m32</i> , <i>imm8</i>	Valid	Valid	Insert a single precision floating-point value selected by <i>imm8</i> from <i>xmm2/m32</i> into <i>xmm1</i> at the specified destination element specified by <i>imm8</i> and zero out destination elements in <i>xmm1</i> as indicated in <i>imm8</i> .

Description

Insert a single-precision floating-point value from the source operand (second operand) into a specified location in the destination register operand (first operand) and selectively zero out the data elements in the destination according to the mask field in the immediate byte (third operand). The source operand can be a memory location (32 bits) or an XMM register.

The immediate byte provides three fields:

COUNT_S: The value of `Imm8[7:6]` selects the dword element from the source register; it is 0 if the source is a memory operand.

COUNT_D: The value of `Imm8[5:4]` selects the target dword element in the destination register.

ZMASK: Each bit of `Imm8[3:0]` selects a dword element in the destination register to be written with 0.0 if set to 1.

Operation

```
IF (SRC == REG) THEN COUNT_S ← imm8[7:6];
    ELSE COUNT_S ← 0; FI;
COUNT_D ← imm8[5:4];
ZMASK ← imm8[3:0];
```

```
CASE (COUNT_S) OF
  0: TMP ← SRC[31:0];
  1: TMP ← SRC[63:32];
  2: TMP ← SRC[95:64];
  3: TMP ← SRC[127:96];
```

```
CASE (COUNT_D) OF
  0: TMP2[31:0] ← TMP;
    TMP2[127:32] ← DEST[127:32];
```

```

1:  TMP2[63:32] ← TMP;
    TMP2[31:0] ← DEST[31:0];
    TMP2[127:64] ← DEST[127:64];
2:  TMP2[95:64] ← TMP;
    TMP2[63:0] ← DEST[63:0];
    TMP2[127:96] ← DEST[127:96];
3:  TMP2[127:96] ← TMP;
    TMP2[95:0] ← DEST[95:0];

IF (ZMASK[0] == 1) THEN DEST[31:0] ← 00000000H;
ELSE DEST[31:0] ← TMP2[31:0];
IF (ZMASK[1] == 1) THEN DEST[63:32] ← 00000000H;
ELSE DEST[63:32] ← TMP2[63:32];
IF (ZMASK[2] == 1) THEN DEST[95:64] ← 00000000H;
ELSE DEST[95:64] ← TMP2[95:64];
IF (ZMASK[3] == 1) THEN DEST[127:96] ← 00000000H;
ELSE DEST[127:96] ← TMP2[127:96];
    FI;
    FI;
    FI;
FI;

```

Intel C/C++ Compiler Intrinsic Equivalent

```
INSERTPS  __m128 __mm_insert_ps(__m128 dst, __m128 src, const int ndx);
```

SIMD Floating-Point Exceptions

None

Protected Mode Exceptions

#GP(0)	For an illegal memory operand effective address in the CS, DS, ES, FS, or GS segments.
#SS(0)	For an illegal address in the SS segment.
#PF(fault-code)	For a page fault.
#NM	If CR0.TS[bit 3] = 1.
#UD	If CR0.EM[bit 2] = 1. If CR4.OSFXSR[bit 9] = 0. If CPUID.01H: ECX.SSE4_1[bit 19] = 0. If LOCK prefix is used. Either the prefix REP (F3h) or REPN (F2H) is used.

#AC(0) If alignment checking is enabled and an unaligned memory reference is made while the current privilege level is 3.

Real Mode Exceptions

#GP(0) if any part of the operand lies outside of the effective address space from 0 to 0FFFFH.

#NM If CR0.TS[bit 3] = 1.

#UD If CR0.EM[bit 2] = 1.

If CR4.OSFXSR[bit 9] = 0.

If CPUID.01H: ECX.SSE4_1[bit 19] = 0.

If LOCK prefix is used.

Either the prefix REP (F3h) or REPN (F2H) is used.

Virtual 8086 Mode Exceptions

Same exceptions as in Real Address Mode.

#PF(fault-code) For a page fault.

Compatibility Mode Exceptions

Same exceptions as in Protected Mode.

64-Bit Mode Exceptions

#GP(0) If the memory address is in a non-canonical form.

#SS(0) If a memory address referencing the SS segment is in a non-canonical form.

#PF(fault-code) For a page fault.

#NM If TS in CR0 is set.

#UD If EM in CR0 is set.

If OSFXSR in CR4 is 0.

If CPUID feature flag ECX.SSE4_1 is 0.

If LOCK prefix is used.

Either the prefix REP (F3h) or REPN (F2H) is used.

#AC(0) If alignment checking is enabled and an unaligned memory reference is made while the current privilege level is 3.

INT *n*/INTO/INT 3—Call to Interrupt Procedure

Opcode	Instruction	64-Bit Mode	Compat/ Leg Mode	Description
CC	INT 3	Valid	Valid	Interrupt 3—trap to debugger.
CD <i>ib</i>	INT <i>imm8</i>	Valid	Valid	Interrupt vector number specified by immediate byte.
CE	INTO	Invalid	Valid	Interrupt 4—if overflow flag is 1.

Description

The INT *n* instruction generates a call to the interrupt or exception handler specified with the destination operand (see the section titled “Interrupts and Exceptions” in Chapter 6 of the *Intel® 64 and IA-32 Architectures Software Developer’s Manual, Volume 1*). The destination operand specifies an interrupt vector number from 0 to 255, encoded as an 8-bit unsigned intermediate value. Each interrupt vector number provides an index to a gate descriptor in the IDT. The first 32 interrupt vector numbers are reserved by Intel for system use. Some of these interrupts are used for internally generated exceptions.

The INT *n* instruction is the general mnemonic for executing a software-generated call to an interrupt handler. The INTO instruction is a special mnemonic for calling overflow exception (#OF), interrupt vector number 4. The overflow interrupt checks the OF flag in the EFLAGS register and calls the overflow interrupt handler if the OF flag is set to 1.

The INT 3 instruction generates a special one byte opcode (CC) that is intended for calling the debug exception handler. (This one byte form is valuable because it can be used to replace the first byte of any instruction with a breakpoint, including other one byte instructions, without over-writing other code). To further support its function as a debug breakpoint, the interrupt generated with the CC opcode also differs from the regular software interrupts as follows:

- Interrupt redirection does not happen when in VME mode; the interrupt is handled by a protected-mode handler.
- The virtual-8086 mode IOPL checks do not occur. The interrupt is taken without faulting at any IOPL level.

Note that the “normal” 2-byte opcode for INT 3 (CD03) does not have these special features. Intel and Microsoft assemblers will not generate the CD03 opcode from any mnemonic, but this opcode can be created by direct numeric code definition or by self-modifying code.

The action of the INT *n* instruction (including the INTO and INT 3 instructions) is similar to that of a far call made with the CALL instruction. The primary difference is that with the INT *n* instruction, the EFLAGS register is pushed onto the stack before the return address. (The return address is a far address consisting of the current values of the CS and EIP registers.) Returns from interrupt procedures are handled

with the IRET instruction, which pops the EFLAGS information and return address from the stack.

The interrupt vector number specifies an interrupt descriptor in the interrupt descriptor table (IDT); that is, it provides index into the IDT. The selected interrupt descriptor in turn contains a pointer to an interrupt or exception handler procedure. In protected mode, the IDT contains an array of 8-byte descriptors, each of which is an interrupt gate, trap gate, or task gate. In real-address mode, the IDT is an array of 4-byte far pointers (2-byte code segment selector and a 2-byte instruction pointer), each of which point directly to a procedure in the selected segment. (Note that in real-address mode, the IDT is called the **interrupt vector table**, and its pointers are called interrupt vectors.)

The following decision table indicates which action in the lower portion of the table is taken given the conditions in the upper portion of the table. Each Y in the lower section of the decision table represents a procedure defined in the “Operation” section for this instruction (except #GP).

Table 3-64. Decision Table

PE	0	1	1	1	1	1	1	1
VM	-	-	-	-	-	0	1	1
IOPL	-	-	-	-	-	-	<3	=3
DPL/CPL RELATIONSHIP	-	DPL< CPL	-	DPL> CPL	DPL= CPL or C	DPL< CPL & NC	-	-
INTERRUPT TYPE	-	S/W	-	-	-	-	-	-
GATE TYPE	-	-	Task	Trap or Interrupt	Trap or Interrupt	Trap or Interrupt	Trap or Interrupt	Trap or Interrupt
REAL-ADDRESS-MODE	Y							
PROTECTED-MODE		Y	Y	Y	Y	Y	Y	Y
TRAP-OR-INTERRUPT-GATE				Y	Y	Y	Y	Y
INTER-PRIVILEGE-LEVEL-INTERRUPT						Y		
INTRA-PRIVILEGE-LEVEL-INTERRUPT					Y			
INTERRUPT-FROM-VIRTUAL-8086-MODE								Y
TASK-GATE			Y					
#GP		Y		Y			Y	

NOTES:

- Don't Care.
- Y Yes, action taken.
- Blank Action not taken.

When the processor is executing in virtual-8086 mode, the IOPL determines the action of the INT *n* instruction. If the IOPL is less than 3, the processor generates a #GP(selector) exception; if the IOPL is 3, the processor executes a protected mode interrupt to privilege level 0. The interrupt gate's DPL must be set to 3 and the target CPL of the interrupt handler procedure must be 0 to execute the protected mode interrupt to privilege level 0.

The interrupt descriptor table register (IDTR) specifies the base linear address and limit of the IDT. The initial base address value of the IDTR after the processor is powered up or reset is 0.

Operation

The following operational description applies not only to the INT *n* and INTO instructions, but also to external interrupts and exceptions.

```

IF PE = 0
  THEN
    GOTO REAL-ADDRESS-MODE;
  ELSE (* PE = 1 *)
    IF (VM = 1 and IOPL < 3 AND INT n)
      THEN
        #GP(0);
      ELSE (* Protected mode, IA-32e mode, or virtual-8086 mode interrupt *)
        IF (IA32_EFER.LMA = 0)
          THEN (* Protected mode, or virtual-8086 mode interrupt *)
            GOTO PROTECTED-MODE;
          ELSE (* IA-32e mode interrupt *)
            GOTO IA-32e-MODE;
        FI;
      FI;
  FI;
REAL-ADDRESS-MODE:
  IF ((vector_number * 4) + 3) is not within IDT limit
    THEN #GP; FI;
  IF stack not large enough for a 6-byte return information
    THEN #SS; FI;
  Push (EFLAGS[15:0]);
  IF ← 0; (* Clear interrupt flag *)
  TF ← 0; (* Clear trap flag *)
  AC ← 0; (* Clear AC flag *)
  Push(CS);
  Push(IP);
  (* No error codes are pushed *)

```

```

CS ← IDT(Descriptor (vector_number * 4), selector);
EIP ← IDT(Descriptor (vector_number * 4), offset); (* 16 bit offset AND 0000FFFFH *)
END;
PROTECTED-MODE:
IF ((vector_number * 8) + 7) is not within IDT limits
or selected IDT descriptor is not an interrupt-, trap-, or task-gate type
  THEN #GP((vector_number * 8) + 2 + EXT); FI;
  (* EXT is bit 0 in error code *)
IF software interrupt (* Generated by INT n, INT 3, or INTO *)
  THEN
    IF gate descriptor DPL < CPL
      THEN #GP((vector_number * 8) + 2 ); FI;
      (* PE = 1, DPL < CPL, software interrupt *)
    FI;
  IF gate not present
    THEN #NP((vector_number * 8) + 2 + EXT); FI;
  IF task gate (* Specified in the selected interrupt table descriptor *)
    THEN GOTO TASK-GATE;
    ELSE GOTO TRAP-OR-INTERRUPT-GATE; (* PE = 1, trap/interrupt gate *)
  FI;
END;
IA-32e-MODE:
IF ((vector_number * 16) + 15) is not in IDT limits
or selected IDT descriptor is not an interrupt-, or trap-gate type
  THEN #GP((vector_number * 16) + 2 + EXT); FI;
  (* EXT is bit 0 in error code *)
IF software interrupt (* Generated by INT n, INT 3, but not INTO *)
  THEN
    IF gate descriptor DPL < CPL
      THEN #GP((vector_number * 16) + 2 ); FI;
      (* PE = 1, DPL < CPL, software interrupt *)
    ELSE (* Generated by INTO *)
      THEN #UD;
    FI;
  IF gate not present
    THEN #NP((vector_number * 16) + 2 + EXT); FI;
  IF ((vector_number * 16)[IST] ≠ 0)
    NewRSP ← TSS[ISTx]; FI;
  GOTO TRAP-OR-INTERRUPT-GATE; (* Trap/interrupt gate *)
END;
TASK-GATE: (* PE = 1, task gate *)
  Read segment selector in task gate (IDT descriptor);
  IF local/global bit is set to local

```

```

    or index not within GDT limits
      THEN #GP(TSS selector); FI;
    Access TSS descriptor in GDT;
    IF TSS descriptor specifies that the TSS is busy (low-order 5 bits set to 00001)
      THEN #GP(TSS selector); FI;
    IF TSS not present
      THEN #NP(TSS selector); FI;
    SWITCH-TASKS (with nesting) to TSS;
    IF interrupt caused by fault with error code
      THEN
        IF stack limit does not allow push of error code
          THEN #SS(0); FI;
        Push(error code);
      FI;
    IF EIP not within code segment limit
      THEN #GP(0); FI;
END;
TRAP-OR-INTERRUPT-GATE:
  Read segment selector for trap or interrupt gate (IDT descriptor);
  IF segment selector for code segment is NULL
    THEN #GP(OH + EXT); FI; (* NULL selector with EXT flag set *)
  IF segment selector is not within its descriptor table limits
    THEN #GP(selector + EXT); FI;
  Read trap or interrupt handler descriptor;
  IF descriptor does not indicate a code segment
  or code segment descriptor DPL > CPL
    THEN #GP(selector + EXT); FI;
  IF trap or interrupt gate segment is not present,
    THEN #NP(selector + EXT); FI;
  IF code segment is non-conforming and DPL < CPL
    THEN
      IF VM = 0
        THEN
          GOTO INTER-PRIVILEGE-LEVEL-INTERRUPT;
          (* PE = 1, interrupt or trap gate, nonconforming
            code segment, DPL < CPL, VM = 0 *)
        ELSE (* VM = 1 *)
          IF code segment DPL ≠ 0
            THEN #GP; (new code segment selector);
          GOTO INTERRUPT-FROM-VIRTUAL-8086-MODE; FI;
          (* PE = 1, interrupt or trap gate, DPL < CPL, VM = 1 *)
        FI;
      ELSE (* PE = 1, interrupt or trap gate, DPL ≥ CPL *)

```

```

    IF VM = 1
        THEN #GP(new code segment selector); FI;
    IF code segment is conforming or code segment DPL = CPL
        THEN
            GOTO INTRA-PRIVILEGE-LEVEL-INTERRUPT;
        ELSE
            #GP(CodeSegmentSelector + EXT);
            (* PE = 1, interrupt or trap gate, nonconforming
            code segment, DPL > CPL *)
    FI;
FI;
END;
INTER-PRIVILEGE-LEVEL-INTERRUPT:
(* PE = 1, interrupt or trap gate, non-conforming code segment, DPL < CPL *)
(* Check segment selector and descriptor for stack of new privilege level in current TSS *)
IF current TSS is 32-bit TSS
    THEN
        TSSstackAddress ← (new code segment DPL * 8) + 4;
        IF (TSSstackAddress + 7) > TSS limit
            THEN #TS(current TSS selector); FI;
        NewSS ← TSSstackAddress + 4;
        NewESP ← stack address;
    ELSE
        IF current TSS is 16-bit TSS
            THEN(* TSS is 16-bit *)
                TSSstackAddress ← (new code segment DPL * 4) + 2
                IF (TSSstackAddress + 4) > TSS limit
                    THEN #TS(current TSS selector); FI;
                NewESP ← TSSstackAddress;
                NewSS ← TSSstackAddress + 2;
            ELSE (* TSS is 64-bit *)
                NewESP ← TSS[RSP FOR NEW TARGET DPL];
                NewSS ← 0;
        FI;
    FI;
IF segment selector is NULL
    THEN #TS(EXT); FI;
IF segment selector index is not within its descriptor table limits
or segment selector's RPL ≠ DPL of code segment,
    THEN #TS(SS selector + EXT); FI;
IF (IA32_EFER.LMA = 0) (* Not IA-32e mode *)
    Read segment descriptor for stack segment in GDT or LDT;
    IF stack segment DPL ≠ DPL of code segment,

```

```

    or stack segment does not indicate writable data segment
      THEN #TS(SS selector + EXT); FI;
  IF stack segment not present
    THEN #SS(SS selector + EXT); FI;
FI
IF 32-bit gate
  THEN
    IF new stack does not have room for 24 bytes (error code pushed)
      or 20 bytes (no error code pushed)
        THEN #SS(segment selector + EXT); FI;
    FI
  ELSE
    IF 16-bit gate
      THEN
        IF new stack does not have room for 12 bytes (error code pushed)
          or 10 bytes (no error code pushed);
          THEN #SS(segment selector + EXT); FI;
        ELSE (* 64-bit gate*)
          IF StackAddress is non-canonical
            THEN #SS(0);FI;
        FI;
    FI;
  IF (IA32_EFER.LMA = 0) (* Not IA-32e mode *)
    THEN
      IF instruction pointer is not within code segment limits
        THEN #GP(0); FI;
      SS:ESP ← TSS(NewSS:NewESP);
      (* Segment descriptor information also loaded *)
    ELSE
      IF instruction pointer points to non-canonical address
        THEN #GP(0); FI;
  FI;
IF 32-bit gate
  THEN
    CS:EIP ← Gate(CS:EIP); (* Segment descriptor information also loaded *)
  ELSE
    IF 16-bit gate
      THEN
        CS:IP ← Gate(CS:IP);
        (* Segment descriptor information also loaded *)
      ELSE (* 64-bit gate *)
        CS:RIP ← Gate(CS:RIP);
        (* Segment descriptor information also loaded *)
    FI;
  FI;

```

```

FI;
IF 32-bit gate
    THEN
        Push(far pointer to old stack);
        (* Old SS and ESP, 3 words padded to 4 *)
        Push(EFLAGS);
        Push(far pointer to return instruction);
        (* Old CS and EIP, 3 words padded to 4 *)
        Push(ErrorCode); (* If needed, 4 bytes *)
    ELSE
        IF 16-bit gate
            THEN
                Push(far pointer to old stack);
                (* Old SS and SP, 2 words *)
                Push(EFLAGS(15-0));
                Push(far pointer to return instruction);
                (* Old CS and IP, 2 words *)
                Push(ErrorCode); (* If needed, 2 bytes *)
            ELSE (* 64-bit gate *)
                Push(far pointer to old stack);
                (* Old SS and SP, each an 8-byte push *)
                Push(RFLAGS); (* 8-byte push *)
                Push(far pointer to return instruction);
                (* Old CS and RIP, each an 8-byte push *)
                Push(ErrorCode); (* If needed, 8-bytes *)
        FI;
    FI;

```

```

FI;
CPL ← CodeSegmentDescriptor(DPL);
CS(RPL) ← CPL;
IF interrupt gate
    THEN IF ← 0 (* Interrupt flag set to 0: disabled *); FI;
    TF ← 0;
    VM ← 0;
    RF ← 0;
    NT ← 0;

```

END;

INTERRUPT-FROM-VIRTUAL-8086-MODE:

(* Check segment selector and descriptor for privilege level 0 stack in current TSS *)

IF current TSS is 32-bit TSS

THEN

TSSstackAddress ← (new code segment DPL * 8) + 4;

IF (TSSstackAddress + 7) > TSS limit

THEN #TS(current TSS selector); FI;

NewSS ← TSSstackAddress + 4;

```

    NewESP ← stack address;
ELSE (* TSS is 16-bit *)
    TSSstackAddress ← (new code segment DPL * 4) + 2;
    IF (TSSstackAddress + 4) > TSS limit
        THEN #TS(current TSS selector); FI;
    NewESP ← TSSstackAddress;
    NewSS ← TSSstackAddress + 2;
FI;
IF segment selector is NULL
    THEN #TS(EXT); FI;
IF segment selector index is not within its descriptor table limits
or segment selector's RPL ≠ DPL of code segment
    THEN #TS(SS selector + EXT); FI;
Access segment descriptor for stack segment in GDT or LDT;
IF stack segment DPL ≠ DPL of code segment,
or stack segment does not indicate writable data segment
    THEN #TS(SS selector + EXT); FI;
IF stack segment not present
    THEN #SS(SS selector + EXT); FI;
IF 32-bit gate
    THEN
        IF new stack does not have room for 40 bytes (error code pushed)
        or 36 bytes (no error code pushed)
            THEN #SS(segment selector + EXT); FI;
ELSE IF 16-bit gate
    THEN
        IF new stack does not have room for 20 bytes (error code pushed)
        or 18 bytes (no error code pushed)
            THEN #SS(segment selector + EXT); FI;
ELSE (* 64-bit gate*)
    IF StackAddress is non-canonical
        THEN #SS(0);
FI;
FI;
IF instruction pointer is not within code segment limits
    THEN #GP(0); FI;
tempEFLAGS ← EFLAGS;
VM ← 0;
TF ← 0;
RF ← 0;
NT ← 0;
IF service through interrupt gate
    THEN IF = 0; FI;

```



```

TempSS ← SS;
TempESP ← ESP;
SS:ESP ← TSS(SS0:ESP0); (* Change to level 0 stack segment *)
(* Following pushes are 16 bits for 16-bit gate and 32 bits for 32-bit gates;
Segment selector pushes in 32-bit mode are padded to two words *)
Push(GS);
Push(FS);
Push(DS);
Push(ES);
Push(TempSS);
Push(TempESP);
Push(TempEFlags);
Push(CS);
Push(EIP);
GS ← 0; (* Segment registers NULLified, invalid in protected mode *)
FS ← 0;
DS ← 0;
ES ← 0;
CS ← Gate(CS);
IF OperandSize = 32
    THEN
        EIP ← Gate(instruction pointer);
    ELSE (* OperandSize is 16 *)
        EIP ← Gate(instruction pointer) AND 0000FFFFH;
FI;
(* Start execution of new routine in Protected Mode *)
END;
INTRA-PRIVILEGE-LEVEL-INTERRUPT:
(* PE = 1, DPL = CPL or conforming segment *)
IF 32-bit gate and IA32_EFER.LMA = 0
    THEN
        IF current stack does not have room for 16 bytes (error code pushed)
        or 12 bytes (no error code pushed)
            THEN #SS(0); FI;
        ELSE IF 16-bit gate
            IF current stack does not have room for 8 bytes (error code pushed)
            or 6 bytes (no error code pushed)
                THEN #SS(0); FI;
            ELSE (* 64-bit gate*)
                IF StackAddress is non-canonical
                    THEN #SS(0);
                FI;
            FI;
        FI;
    FI;

```

```

IF instruction pointer not within code segment limit
    THEN #GP(0); FI;
IF 32-bit gate
    THEN
        Push (EFLAGS);
        Push (far pointer to return instruction); (* 3 words padded to 4 *)
        CS:EIP ← Gate(CS:EIP); (* Segment descriptor information also loaded *)
        Push (ErrorCode); (* If any *)
    ELSE
        IF 16-bit gate
            THEN
                Push (FLAGS);
                Push (far pointer to return location); (* 2 words *)
                CS:IP ← Gate(CS:IP);
                (* Segment descriptor information also loaded *)
                Push (ErrorCode); (* If any *)
            ELSE (* 64-bit gate*)
                Push(far pointer to old stack);
                (* Old SS and SP, each an 8-byte push *)
                Push(RFLAGS); (* 8-byte push *)
                Push(far pointer to return instruction);
                (* Old CS and RIP, each an 8-byte push *)
                Push(ErrorCode); (* If needed, 8 bytes *)
                CS:RIP ← GATE(CS:RIP);
                (* Segment descriptor information also loaded *)
            FI;
        FI;
CS(RPL) ← CPL;
IF interrupt gate
    THEN IF ← 0; FI; (* Interrupt flag set to 0: disabled *)
    TF ← 0;
    NT ← 0;
    VM ← 0;
    RF ← 0;
END;

```

Flags Affected

The EFLAGS register is pushed onto the stack. The IF, TF, NT, AC, RF, and VM flags may be cleared, depending on the mode of operation of the processor when the INT instruction is executed (see the “Operation” section). If the interrupt uses a task gate, any flags may be set or cleared, controlled by the EFLAGS image in the new task’s TSS.

Protected Mode Exceptions

#GP(0)	If the instruction pointer in the IDT or in the interrupt-, trap-, or task gate is beyond the code segment limits.
#GP(selector)	<p>If the segment selector in the interrupt-, trap-, or task gate is NULL.</p> <p>If an interrupt-, trap-, or task gate, code segment, or TSS segment selector index is outside its descriptor table limits.</p> <p>If the interrupt vector number is outside the IDT limits.</p> <p>If an IDT descriptor is not an interrupt-, trap-, or task-descriptor.</p> <p>If an interrupt is generated by the INT <i>n</i>, INT 3, or INTO instruction and the DPL of an interrupt-, trap-, or task-descriptor is less than the CPL.</p> <p>If the segment selector in an interrupt- or trap-gate does not point to a segment descriptor for a code segment.</p> <p>If the segment selector for a TSS has its local/global bit set for local.</p> <p>If a TSS segment descriptor specifies that the TSS is busy or not available.</p>
#SS(0)	If pushing the return address, flags, or error code onto the stack exceeds the bounds of the stack segment and no stack switch occurs.
#SS(selector)	<p>If the SS register is being loaded and the segment pointed to is marked not present.</p> <p>If pushing the return address, flags, error code, or stack segment pointer exceeds the bounds of the new stack segment when a stack switch occurs.</p>
#NP(selector)	If code segment, interrupt-, trap-, or task gate, or TSS is not present.
#TS(selector)	<p>If the RPL of the stack segment selector in the TSS is not equal to the DPL of the code segment being accessed by the interrupt or trap gate.</p> <p>If DPL of the stack segment descriptor pointed to by the stack segment selector in the TSS is not equal to the DPL of the code segment descriptor for the interrupt or trap gate.</p> <p>If the stack segment selector in the TSS is NULL.</p> <p>If the stack segment for the TSS is not a writable data segment.</p> <p>If segment-selector index for stack segment is outside descriptor table limits.</p>
#PF(fault-code)	If a page fault occurs.
#UD	If the LOCK prefix is used.

Real-Address Mode Exceptions

#GP	If a memory operand effective address is outside the CS, DS, ES, FS, or GS segment limit. If the interrupt vector number is outside the IDT limits.
#SS	If stack limit violation on push. If pushing the return address, flags, or error code onto the stack exceeds the bounds of the stack segment.
#UD	If the LOCK prefix is used.

Virtual-8086 Mode Exceptions

#GP(0)	(For INT <i>n</i> , INTO, or BOUND instruction) If the IOPL is less than 3 or the DPL of the interrupt-, trap-, or task-gate descriptor is not equal to 3. If the instruction pointer in the IDT or in the interrupt-, trap-, or task gate is beyond the code segment limits.
#GP(selector)	If the segment selector in the interrupt-, trap-, or task gate is NULL. If a interrupt-, trap-, or task gate, code segment, or TSS segment selector index is outside its descriptor table limits. If the interrupt vector number is outside the IDT limits. If an IDT descriptor is not an interrupt-, trap-, or task-descriptor. If an interrupt is generated by the INT <i>n</i> instruction and the DPL of an interrupt-, trap-, or task-descriptor is less than the CPL. If the segment selector in an interrupt- or trap-gate does not point to a segment descriptor for a code segment. If the segment selector for a TSS has its local/global bit set for local.
#SS(selector)	If the SS register is being loaded and the segment pointed to is marked not present. If pushing the return address, flags, error code, stack segment pointer, or data segments exceeds the bounds of the stack segment.
#NP(selector)	If code segment, interrupt-, trap-, or task gate, or TSS is not present.
#TS(selector)	If the RPL of the stack segment selector in the TSS is not equal to the DPL of the code segment being accessed by the interrupt or trap gate. If DPL of the stack segment descriptor for the TSS's stack segment is not equal to the DPL of the code segment descriptor for the interrupt or trap gate. If the stack segment selector in the TSS is NULL.

	If the stack segment for the TSS is not a writable data segment. If segment-selector index for stack segment is outside descriptor table limits.
#PF(fault-code)	If a page fault occurs.
#BP	If the INT 3 instruction is executed.
#OF	If the INTO instruction is executed and the OF flag is set.
#UD	If the LOCK prefix is used.

Compatibility Mode Exceptions

Same exceptions as in protected mode.

64-Bit Mode Exceptions

#GP(0)	If the instruction pointer in the 64-bit interrupt gate or 64-bit trap gate is non-canonical.
#GP(selector)	If the segment selector in the 64-bit interrupt or trap gate is NULL. If the interrupt vector number is outside the IDT limits. If the interrupt vector number points to a gate which is in non-canonical space. If the interrupt vector number points to a descriptor which is not a 64-bit interrupt gate or 64-bit trap gate. If the descriptor pointed to by the gate selector is outside the descriptor table limit. If the descriptor pointed to by the gate selector is in non-canonical space. If the descriptor pointed to by the gate selector is not a code segment. If the descriptor pointed to by the gate selector doesn't have the L-bit set, or has both the L-bit and D-bit set. If the descriptor pointed to by the gate selector has $DPL > CPL$.
#SS(0)	If a push of the old EFLAGS, CS selector, EIP, or error code is in non-canonical space with no stack switch.
#SS(selector)	If a push of the old SS selector, ESP, EFLAGS, CS selector, EIP, or error code is in non-canonical space on a stack switch (either CPL change or no-CPL with IST).
#NP(selector)	If the 64-bit interrupt-gate, 64-bit trap-gate, or code segment is not present.

INSTRUCTION SET REFERENCE, A-M

#TS(selector)	If an attempt to load RSP from the TSS causes an access to non-canonical space. If the RSP from the TSS is outside descriptor table limits.
#PF(fault-code)	If a page fault occurs.
#UD	If the LOCK prefix is used.

INVD—Invalidate Internal Caches

Opcode*	Instruction	64-Bit Mode	Compat/ Leg Mode	Description
OF 08	INVD	Valid	Valid	Flush internal caches; initiate flushing of external caches.

NOTES:

* See the IA-32 Architecture Compatibility section below.

Description

Invalidates (flushes) the processor's internal caches and issues a special-function bus cycle that directs external caches to also flush themselves. Data held in internal caches is not written back to main memory.

After executing this instruction, the processor does not wait for the external caches to complete their flushing operation before proceeding with instruction execution. It is the responsibility of hardware to respond to the cache flush signal.

The INVD instruction is a privileged instruction. When the processor is running in protected mode, the CPL of a program or procedure must be 0 to execute this instruction.

Use this instruction with care. Data cached internally and not written back to main memory will be lost. Unless there is a specific requirement or benefit to flushing caches without writing back modified cache lines (for example, testing or fault recovery where cache coherency with main memory is not a concern), software should use the WBINVD instruction.

This instruction's operation is the same in non-64-bit modes and 64-bit mode.

IA-32 Architecture Compatibility

The INVD instruction is implementation dependent; it may be implemented differently on different families of Intel 64 or IA-32 processors. This instruction is not supported on IA-32 processors earlier than the Intel486 processor.

Operation

Flush(InternalCaches);
SignalFlush(ExternalCaches);
Continue (* Continue execution *)

Flags Affected

None.

Protected Mode Exceptions

- #GP(0) If the current privilege level is not 0.
- #UD If the LOCK prefix is used.

Real-Address Mode Exceptions

- #UD If the LOCK prefix is used.

Virtual-8086 Mode Exceptions

- #GP(0) The INVD instruction cannot be executed in virtual-8086 mode.

Compatibility Mode Exceptions

Same exceptions as in protected mode.

64-Bit Mode Exceptions

Same exceptions as in protected mode.

INVLPG—Invalidate TLB Entry

Opcode	Instruction	64-Bit Mode	Compat/Leg Mode	Description
OF 01/7	INVLPG <i>m</i>	Valid	Valid	Invalidate TLB Entry for page that contains <i>m</i> .

NOTES:

* See the IA-32 Architecture Compatibility section below.

Description

Invalidates (flushes) the translation lookaside buffer (TLB) entry specified with the source operand. The source operand is a memory address. The processor determines the page that contains that address and flushes the TLB entry for that page.

The INVLPG instruction is a privileged instruction. When the processor is running in protected mode, the CPL of a program or procedure must be 0 to execute this instruction.

The INVLPG instruction normally flushes the TLB entry only for the specified page; however, in some cases, it flushes the entire TLB. See “MOV—Move to/from Control Registers” in this chapter for further information on operations that flush the TLB.

This instruction’s operation is the same in all non-64-bit modes. It also operates the same in 64-bit mode, except if the memory address is in non-canonical form. In this case, INVLPG is the same as a NOP.

IA-32 Architecture Compatibility

The INVLPG instruction is implementation dependent, and its function may be implemented differently on different families of Intel 64 or IA-32 processors. This instruction is not supported on IA-32 processors earlier than the Intel486 processor.

Operation

Flush(RelevantTLBEntries);
Continue; (* Continue execution *)

Flags Affected

None.

Protected Mode Exceptions

#GP(0) If the current privilege level is not 0.

#UD Operand is a register.
If the LOCK prefix is used.

Real-Address Mode Exceptions

#UD Operand is a register.
 If the LOCK prefix is used.

Virtual-8086 Mode Exceptions

#GP(0) The INVLPG instruction cannot be executed at the virtual-8086 mode.

64-Bit Mode Exceptions

#GP(0) If the current privilege level is not 0.
#UD Operand is a register.
 If the LOCK prefix is used.

IRET/IRETD—Interrupt Return

Opcode	Instruction	64-Bit Mode	Compat/ Leg Mode	Description
CF	IRET	Valid	Valid	Interrupt return (16-bit operand size).
CF	IRETD	Valid	Valid	Interrupt return (32-bit operand size).
REX.W + CF	IRETQ	Valid	N.E.	Interrupt return (64-bit operand size).

Description

Returns program control from an exception or interrupt handler to a program or procedure that was interrupted by an exception, an external interrupt, or a software-generated interrupt. These instructions are also used to perform a return from a nested task. (A nested task is created when a CALL instruction is used to initiate a task switch or when an interrupt or exception causes a task switch to an interrupt or exception handler.) See the section titled “Task Linking” in Chapter 7 of the *Intel® 64 and IA-32 Architectures Software Developer’s Manual, Volume 3A*.

IRET and IRETD are mnemonics for the same opcode. The IRETD mnemonic (interrupt return double) is intended for use when returning from an interrupt when using the 32-bit operand size; however, most assemblers use the IRET mnemonic interchangeably for both operand sizes.

In Real-Address Mode, the IRET instruction performs a far return to the interrupted program or procedure. During this operation, the processor pops the return instruction pointer, return code segment selector, and EFLAGS image from the stack to the EIP, CS, and EFLAGS registers, respectively, and then resumes execution of the interrupted program or procedure.

In Protected Mode, the action of the IRET instruction depends on the settings of the NT (nested task) and VM flags in the EFLAGS register and the VM flag in the EFLAGS image stored on the current stack. Depending on the setting of these flags, the processor performs the following types of interrupt returns:

- Return from virtual-8086 mode.
- Return to virtual-8086 mode.
- Intra-privilege level return.
- Inter-privilege level return.
- Return from nested task (task switch).

If the NT flag (EFLAGS register) is cleared, the IRET instruction performs a far return from the interrupt procedure, without a task switch. The code segment being returned to must be equally or less privileged than the interrupt handler routine (as indicated by the RPL field of the code segment selector popped from the stack).

As with a real-address mode interrupt return, the IRET instruction pops the return instruction pointer, return code segment selector, and EFLAGS image from the stack to the EIP, CS, and EFLAGS registers, respectively, and then resumes execution of the interrupted program or procedure. If the return is to another privilege level, the IRET instruction also pops the stack pointer and SS from the stack, before resuming program execution. If the return is to virtual-8086 mode, the processor also pops the data segment registers from the stack.

If the NT flag is set, the IRET instruction performs a task switch (return) from a nested task (a task called with a CALL instruction, an interrupt, or an exception) back to the calling or interrupted task. The updated state of the task executing the IRET instruction is saved in its TSS. If the task is re-entered later, the code that follows the IRET instruction is executed.

If the NT flag is set and the processor is in IA-32e mode, the IRET instruction causes a general protection exception.

In 64-bit mode, the instruction's default operation size is 32 bits. Use of the REX.W prefix promotes operation to 64 bits (IRETQ). See the summary chart at the beginning of this section for encoding data and limits.

See "Changes to Instruction Behavior in VMX Non-Root Operation" in Chapter 22 of the *Intel® 64 and IA-32 Architectures Software Developer's Manual, Volume 3B*, for more information about the behavior of this instruction in VMX non-root operation.

Operation

```

IF PE = 0
  THEN
    GOTO REAL-ADDRESS-MODE;
  ELSE
    IF (IA32_EFER.LMA = 0)
      THEN (* Protected mode *)
        GOTO PROTECTED-MODE;
      ELSE (* IA-32e mode *)
        GOTO IA-32e-MODE;
    FI;
  FI;
REAL-ADDRESS-MODE;
  IF OperandSize = 32
    THEN
      IF top 12 bytes of stack not within stack limits
        THEN #SS; FI;
      tempEIP ← 4 bytes at end of stack
      IF tempEIP[31:16] is not zero THEN #GP(0); FI;
      EIP ← Pop();
      CS ← Pop(); (* 32-bit pop, high-order 16 bits discarded *)
      tempEFLAGS ← Pop();
    
```

```

    EFLAGS ← (tempEFLAGS AND 257FD5H) OR (EFLAGS AND 1A0000H);
ELSE (* OperandSize = 16 *)
    IF top 6 bytes of stack are not within stack limits
        THEN #SS; FI;
    EIP ← Pop(); (* 16-bit pop; clear upper 16 bits *)
    CS ← Pop(); (* 16-bit pop *)
    EFLAGS[15:0] ← Pop();
FI;
END;
PROTECTED-MODE:
    IF VM = 1 (* Virtual-8086 mode: PE = 1, VM = 1 *)
        THEN
            GOTO RETURN-FROM-VIRTUAL-8086-MODE; (* PE = 1, VM = 1 *)
    FI;
    IF NT = 1
        THEN
            GOTO TASK-RETURN; (* PE = 1, VM = 0, NT = 1 *)
    FI;
    IF OperandSize = 32
        THEN
            IF top 12 bytes of stack not within stack limits
                THEN #SS(0); FI;
            tempEIP ← Pop();
            tempCS ← Pop();
            tempEFLAGS ← Pop();
        ELSE (* OperandSize = 16 *)
            IF top 6 bytes of stack are not within stack limits
                THEN #SS(0); FI;
            tempEIP ← Pop();
            tempCS ← Pop();
            tempEFLAGS ← Pop();
            tempEIP ← tempEIP AND FFFFH;
            tempEFLAGS ← tempEFLAGS AND FFFFH;
        FI;
    IF tempEFLAGS(VM) = 1 and CPL = 0
        THEN
            GOTO RETURN-TO-VIRTUAL-8086-MODE;
        ELSE
            GOTO PROTECTED-MODE-RETURN;
    FI;
IA-32e-MODE:
    IF NT = 1
        THEN #GP(0);

```

```

ELSE IF OperandSize = 32
  THEN
    IF top 12 bytes of stack not within stack limits
      THEN #SS(0); FI;
    tempEIP ← Pop();
    tempCS ← Pop();
    tempEFLAGS ← Pop();
  ELSE IF OperandSize = 16
    THEN
      IF top 6 bytes of stack are not within stack limits
        THEN #SS(0); FI;
      tempEIP ← Pop();
      tempCS ← Pop();
      tempEFLAGS ← Pop();
      tempEIP ← tempEIP AND FFFFH;
      tempEFLAGS ← tempEFLAGS AND FFFFH;
    FI;
  ELSE (* OperandSize = 64 *)
    THEN
      tempRIP ← Pop();
      tempCS ← Pop();
      tempEFLAGS ← Pop();
      tempRSP ← Pop();
      tempSS ← Pop();
  FI;
GOTO IA-32e-MODE-RETURN;

```

RETURN-FROM-VIRTUAL-8086-MODE:

(* Processor is in virtual-8086 mode when IRET is executed and stays in virtual-8086 mode *)

```

IF IOPL = 3 (* Virtual mode: PE = 1, VM = 1, IOPL = 3 *)
  THEN IF OperandSize = 32
    THEN
      IF top 12 bytes of stack not within stack limits
        THEN #SS(0); FI;
      IF instruction pointer not within code segment limits
        THEN #GP(0); FI;
      EIP ← Pop();
      CS ← Pop(); (* 32-bit pop, high-order 16 bits discarded *)
      EFLAGS ← Pop();
      (* VM, IOPL, VIP and VIF EFLAG bits not modified by pop *)
    ELSE (* OperandSize = 16 *)
      IF top 6 bytes of stack are not within stack limits
        THEN #SS(0); FI;
      IF instruction pointer not within code segment limits

```

```

        THEN #GP(0); FI;
        EIP ← Pop();
        EIP ← EIP AND 0000FFFFH;
        CS ← Pop(); (* 16-bit pop *)
        EFLAGS[15:0] ← Pop(); (* IOPL in EFLAGS not modified by pop *)
    FI;
ELSE
    #GP(0); (* Trap to virtual-8086 monitor: PE = 1, VM = 1, IOPL < 3 *)
FI;
END;

RETURN-TO-VIRTUAL-8086-MODE:
(* Interrupted procedure was in virtual-8086 mode: PE = 1, CPL=0, VM = 1 in flag image *)
IF top 24 bytes of stack are not within stack segment limits
    THEN #SS(0); FI;
IF instruction pointer not within code segment limits
    THEN #GP(0); FI;
CS ← tempCS;
EIP ← tempEIP;
EFLAGS ← tempEFLAGS;
TempESP ← Pop();
TempSS ← Pop();
ES ← Pop(); (* Pop 2 words; throw away high-order word *)
DS ← Pop(); (* Pop 2 words; throw away high-order word *)
FS ← Pop(); (* Pop 2 words; throw away high-order word *)
GS ← Pop(); (* Pop 2 words; throw away high-order word *)
SS:ESP ← TempSS:TempESP;
CPL ← 3;
(* Resume execution in Virtual-8086 mode *)
END;

TASK-RETURN: (* PE = 1, VM = 0, NT = 1 *)
    Read segment selector in link field of current TSS;
    IF local/global bit is set to local
    or index not within GDT limits
        THEN #TS (TSS selector); FI;
    Access TSS for task specified in link field of current TSS;
    IF TSS descriptor type is not TSS or if the TSS is marked not busy
        THEN #TS (TSS selector); FI;
    IF TSS not present
        THEN #NP(TSS selector); FI;
    SWITCH-TASKS (without nesting) to TSS specified in link field of current TSS;
    Mark the task just abandoned as NOT BUSY;

```

```

    IF EIP is not within code segment limit
        THEN #GP(0); FI;
END;

PROTECTED-MODE-RETURN: (* PE = 1 *)
    IF return code segment selector is NULL
        THEN GP(0); FI;
    IF return code segment selector addresses descriptor beyond descriptor table limit
        THEN GP(selector); FI;
    Read segment descriptor pointed to by the return code segment selector;
    IF return code segment descriptor is not a code segment
        THEN #GP(selector); FI;
    IF return code segment selector RPL < CPL
        THEN #GP(selector); FI;
    IF return code segment descriptor is conforming
    and return code segment DPL > return code segment selector RPL
        THEN #GP(selector); FI;
    IF return code segment descriptor is not present
        THEN #NP(selector); FI;
    IF return code segment selector RPL > CPL
        THEN GOTO RETURN-OUTER-PRIVILEGE-LEVEL;
        ELSE GOTO RETURN-TO-SAME-PRIVILEGE-LEVEL; FI;
END;

RETURN-TO-SAME-PRIVILEGE-LEVEL: (* PE = 1, RPL = CPL *)
    IF new mode ≠ 64-Bit Mode
        THEN
            IF tempEIP is not within code segment limits
                THEN #GP(0); FI;
            EIP ← tempEIP;
        ELSE (* new mode = 64-bit mode *)
            IF tempRIP is non-canonical
                THEN #GP(0); FI;
            RIP ← tempRIP;
    FI;
    CS ← tempCS; (* Segment descriptor information also loaded *)
    EFLAGS (CF, PF, AF, ZF, SF, TF, DF, OF, NT) ← tempEFLAGS;
    IF OperandSize = 32 or OperandSize = 64
        THEN EFLAGS(RF, AC, ID) ← tempEFLAGS; FI;
    IF CPL ≤ IOPL
        THEN EFLAGS(IF) ← tempEFLAGS; FI;
    IF CPL = 0
        THEN (* VM = 0 in flags image *)

```



```

    EFLAGS(IOPL) ← tempEFLAGS;
    IF OperandSize = 32 or OperandSize = 64
        THEN EFLAGS(VIF, VIP) ← tempEFLAGS; FI;
    FI;
END;

RETURN-TO-OUTER-PRIVILEGE-LEVEL:
    IF OperandSize = 32
        THEN
            IF top 8 bytes on stack are not within limits
                THEN #SS(0); FI;
            ELSE (* OperandSize = 16 *)
                IF top 4 bytes on stack are not within limits
                    THEN #SS(0); FI;
            FI;
        Read return segment selector;
        IF stack segment selector is NULL
            THEN #GP(0); FI;
        IF return stack segment selector index is not within its descriptor table limits
            THEN #GP(SSselector); FI;
        Read segment descriptor pointed to by return segment selector;
        IF stack segment selector RPL ≠ RPL of the return code segment selector
        or the stack segment descriptor does not indicate a writable data segment;
        or the stack segment DPL ≠ RPL of the return code segment selector
            THEN #GP(SS selector); FI;
        IF stack segment is not present
            THEN #SS(SS selector); FI;
        IF new mode ≠ 64-Bit Mode
            THEN
                IF tempEIP is not within code segment limits
                    THEN #GP(0); FI;
                EIP ← tempEIP;
            ELSE (* new mode = 64-bit mode *)
                IF tempRIP is non-canonical
                    THEN #GP(0); FI;
                RIP ← tempRIP;
            FI;
        CS ← tempCS;
        EFLAGS (CF, PF, AF, ZF, SF, TF, DF, OF, NT) ← tempEFLAGS;
        IF OperandSize = 32
            THEN EFLAGS(RF, AC, ID) ← tempEFLAGS; FI;
        IF CPL ≤ IOPL
            THEN EFLAGS(IF) ← tempEFLAGS; FI;

```

```

IF CPL = 0
  THEN
    EFLAGS(IOPL) ← tempEFLAGS;
    IF OperandSize = 32
      THEN EFLAGS(VM, VIF, VIP) ← tempEFLAGS; FI;
    IF OperandSize = 64
      THEN EFLAGS(VIF, VIP) ← tempEFLAGS; FI;
  FI;
CPL ← RPL of the return code segment selector;
FOR each of segment register (ES, FS, GS, and DS)
  DO
    IF segment register points to data or non-conforming code segment
      and CPL > segment descriptor DPL (* Stored in hidden part of segment register *)
      THEN (* Segment register invalid *)
        SegmentSelector ← 0; (* NULL segment selector *)
      FI;
  OD;
END;

IA-32e-MODE-RETURN: (* IA32_EFER.LMA = 1, PE = 1 *)
  IF ( (return code segment selector is NULL) or (return RIP is non-canonical) or
      (SS selector is NULL going back to compatibility mode) or
      (SS selector is NULL going back to CPL3 64-bit mode) or
      (RPL <> CPL going back to non-CPL3 64-bit mode for a NULL SS selector) )
    THEN GP(0); FI;
  IF return code segment selector addresses descriptor beyond descriptor table limit
    THEN GP(selector); FI;
  Read segment descriptor pointed to by the return code segment selector;
  IF return code segment descriptor is not a code segment
    THEN #GP(selector); FI;
  IF return code segment selector RPL < CPL
    THEN #GP(selector); FI;
  IF return code segment descriptor is conforming
    and return code segment DPL > return code segment selector RPL
    THEN #GP(selector); FI;
  IF return code segment descriptor is not present
    THEN #NP(selector); FI;
  IF return code segment selector RPL > CPL
    THEN GOTO RETURN-OUTER-PRIVILEGE-LEVEL;
    ELSE GOTO RETURN-TO-SAME-PRIVILEGE-LEVEL; FI;
END;

```

Flags Affected

All the flags and fields in the EFLAGS register are potentially modified, depending on the mode of operation of the processor. If performing a return from a nested task to a previous task, the EFLAGS register will be modified according to the EFLAGS image stored in the previous task's TSS.

Protected Mode Exceptions

#GP(0)	If the return code or stack segment selector is NULL. If the return instruction pointer is not within the return code segment limit.
#GP(selector)	If a segment selector index is outside its descriptor table limits. If the return code segment selector RPL is greater than the CPL. If the DPL of a conforming-code segment is greater than the return code segment selector RPL. If the DPL for a nonconforming-code segment is not equal to the RPL of the code segment selector. If the stack segment descriptor DPL is not equal to the RPL of the return code segment selector. If the stack segment is not a writable data segment. If the stack segment selector RPL is not equal to the RPL of the return code segment selector. If the segment descriptor for a code segment does not indicate it is a code segment. If the segment selector for a TSS has its local/global bit set for local. If a TSS segment descriptor specifies that the TSS is not busy. If a TSS segment descriptor specifies that the TSS is not available.
#SS(0)	If the top bytes of stack are not within stack limits.
#NP(selector)	If the return code or stack segment is not present.
#PF(fault-code)	If a page fault occurs.
#AC(0)	If an unaligned memory reference occurs when the CPL is 3 and alignment checking is enabled.
#UD	If the LOCK prefix is used.

Real-Address Mode Exceptions

#GP	If the return instruction pointer is not within the return code segment limit.
#SS	If the top bytes of stack are not within stack limits.

Virtual-8086 Mode Exceptions

#GP(0)	If the return instruction pointer is not within the return code segment limit. If IOPL not equal to 3.
#PF(fault-code)	If a page fault occurs.
#SS(0)	If the top bytes of stack are not within stack limits.
#AC(0)	If an unaligned memory reference occurs and alignment checking is enabled.
#UD	If the LOCK prefix is used.

Compatibility Mode Exceptions

#GP(0)	If EFLAGS.NT[bit 14] = 1.
--------	---------------------------

Other exceptions same as in Protected Mode.

64-Bit Mode Exceptions

#GP(0)	If EFLAGS.NT[bit 14] = 1. If the return code segment selector is NULL. If the stack segment selector is NULL going back to compatibility mode. If the stack segment selector is NULL going back to CPL3 64-bit mode. If a NULL stack segment selector RPL is not equal to CPL going back to non-CPL3 64-bit mode. If the return instruction pointer is not within the return code segment limit. If the return instruction pointer is non-canonical.
#GP(Selector)	If a segment selector index is outside its descriptor table limits. If a segment descriptor memory address is non-canonical. If the segment descriptor for a code segment does not indicate it is a code segment. If the proposed new code segment descriptor has both the D-bit and L-bit set. If the DPL for a nonconforming-code segment is not equal to the RPL of the code segment selector. If CPL is greater than the RPL of the code segment selector. If the DPL of a conforming-code segment is greater than the return code segment selector RPL. If the stack segment is not a writable data segment. If the stack segment descriptor DPL is not equal to the RPL of the return code segment selector.

	If the stack segment selector RPL is not equal to the RPL of the return code segment selector.
#SS(0)	If an attempt to pop a value off the stack violates the SS limit. If an attempt to pop a value off the stack causes a non-canonical address to be referenced.
#NP(selector)	If the return code or stack segment is not present.
#PF(fault-code)	If a page fault occurs.
#AC(0)	If an unaligned memory reference occurs when the CPL is 3 and alignment checking is enabled.
#UD	If the LOCK prefix is used.

Jcc—Jump if Condition Is Met

Opcode	Instruction	64-Bit Mode	Compat/ Leg Mode	Description
77 <i>cb</i>	<i>JA rel8</i>	Valid	Valid	Jump short if above (CF=0 and ZF=0).
73 <i>cb</i>	<i>JAE rel8</i>	Valid	Valid	Jump short if above or equal (CF=0).
72 <i>cb</i>	<i>JB rel8</i>	Valid	Valid	Jump short if below (CF=1).
76 <i>cb</i>	<i>JBE rel8</i>	Valid	Valid	Jump short if below or equal (CF=1 or ZF=1).
72 <i>cb</i>	<i>JC rel8</i>	Valid	Valid	Jump short if carry (CF=1).
E3 <i>cb</i>	<i>JCXZ rel8</i>	N.E.	Valid	Jump short if CX register is 0.
E3 <i>cb</i>	<i>JECXZ rel8</i>	Valid	Valid	Jump short if ECX register is 0.
E3 <i>cb</i>	<i>JRCXZ rel8</i>	Valid	N.E.	Jump short if RCX register is 0.
74 <i>cb</i>	<i>JE rel8</i>	Valid	Valid	Jump short if equal (ZF=1).
7F <i>cb</i>	<i>JG rel8</i>	Valid	Valid	Jump short if greater (ZF=0 and SF=0F).
7D <i>cb</i>	<i>JGE rel8</i>	Valid	Valid	Jump short if greater or equal (SF=0F).
7C <i>cb</i>	<i>JL rel8</i>	Valid	Valid	Jump short if less (SF≠ 0F).
7E <i>cb</i>	<i>JLE rel8</i>	Valid	Valid	Jump short if less or equal (ZF=1 or SF≠ 0F).
76 <i>cb</i>	<i>JNA rel8</i>	Valid	Valid	Jump short if not above (CF=1 or ZF=1).
72 <i>cb</i>	<i>JNAE rel8</i>	Valid	Valid	Jump short if not above or equal (CF=1).
73 <i>cb</i>	<i>JNB rel8</i>	Valid	Valid	Jump short if not below (CF=0).
77 <i>cb</i>	<i>JNBE rel8</i>	Valid	Valid	Jump short if not below or equal (CF=0 and ZF=0).
73 <i>cb</i>	<i>JNC rel8</i>	Valid	Valid	Jump short if not carry (CF=0).
75 <i>cb</i>	<i>JNE rel8</i>	Valid	Valid	Jump short if not equal (ZF=0).
7E <i>cb</i>	<i>JNG rel8</i>	Valid	Valid	Jump short if not greater (ZF=1 or SF≠ 0F).
7C <i>cb</i>	<i>JNGE rel8</i>	Valid	Valid	Jump short if not greater or equal (SF≠ 0F).
7D <i>cb</i>	<i>JNL rel8</i>	Valid	Valid	Jump short if not less (SF=0F).
7F <i>cb</i>	<i>JNLE rel8</i>	Valid	Valid	Jump short if not less or equal (ZF=0 and SF=0F).
71 <i>cb</i>	<i>JNO rel8</i>	Valid	Valid	Jump short if not overflow (OF=0).
7B <i>cb</i>	<i>JNP rel8</i>	Valid	Valid	Jump short if not parity (PF=0).
79 <i>cb</i>	<i>JNS rel8</i>	Valid	Valid	Jump short if not sign (SF=0).

Opcode	Instruction	64-Bit Mode	Compat/ Leg Mode	Description
75 <i>cb</i>	JNZ <i>rel8</i>	Valid	Valid	Jump short if not zero (ZF=0).
70 <i>cb</i>	JO <i>rel8</i>	Valid	Valid	Jump short if overflow (OF=1).
7A <i>cb</i>	JP <i>rel8</i>	Valid	Valid	Jump short if parity (PF=1).
7A <i>cb</i>	JPE <i>rel8</i>	Valid	Valid	Jump short if parity even (PF=1).
7B <i>cb</i>	JPO <i>rel8</i>	Valid	Valid	Jump short if parity odd (PF=0).
78 <i>cb</i>	JS <i>rel8</i>	Valid	Valid	Jump short if sign (SF=1).
74 <i>cb</i>	JZ <i>rel8</i>	Valid	Valid	Jump short if zero (ZF ← 1).
0F 87 <i>cw</i>	JA <i>rel16</i>	N.S.	Valid	Jump near if above (CF=0 and ZF=0). Not supported in 64-bit mode.
0F 87 <i>cd</i>	JA <i>rel32</i>	Valid	Valid	Jump near if above (CF=0 and ZF=0).
0F 83 <i>cw</i>	JAЕ <i>rel16</i>	N.S.	Valid	Jump near if above or equal (CF=0). Not supported in 64-bit mode.
0F 83 <i>cd</i>	JAЕ <i>rel32</i>	Valid	Valid	Jump near if above or equal (CF=0).
0F 82 <i>cw</i>	JB <i>rel16</i>	N.S.	Valid	Jump near if below (CF=1). Not supported in 64-bit mode.
0F 82 <i>cd</i>	JB <i>rel32</i>	Valid	Valid	Jump near if below (CF=1).
0F 86 <i>cw</i>	JBE <i>rel16</i>	N.S.	Valid	Jump near if below or equal (CF=1 or ZF=1). Not supported in 64-bit mode.
0F 86 <i>cd</i>	JBE <i>rel32</i>	Valid	Valid	Jump near if below or equal (CF=1 or ZF=1).
0F 82 <i>cw</i>	JC <i>rel16</i>	N.S.	Valid	Jump near if carry (CF=1). Not supported in 64-bit mode.
0F 82 <i>cd</i>	JC <i>rel32</i>	Valid	Valid	Jump near if carry (CF=1).
0F 84 <i>cw</i>	JE <i>rel16</i>	N.S.	Valid	Jump near if equal (ZF=1). Not supported in 64-bit mode.
0F 84 <i>cd</i>	JE <i>rel32</i>	Valid	Valid	Jump near if equal (ZF=1).
0F 84 <i>cw</i>	JZ <i>rel16</i>	N.S.	Valid	Jump near if 0 (ZF=1). Not supported in 64-bit mode.
0F 84 <i>cd</i>	JZ <i>rel32</i>	Valid	Valid	Jump near if 0 (ZF=1).
0F 8F <i>cw</i>	JG <i>rel16</i>	N.S.	Valid	Jump near if greater (ZF=0 and SF=OF). Not supported in 64-bit mode.
0F 8F <i>cd</i>	JG <i>rel32</i>	Valid	Valid	Jump near if greater (ZF=0 and SF=OF).
0F 8D <i>cw</i>	JGE <i>rel16</i>	N.S.	Valid	Jump near if greater or equal (SF=OF). Not supported in 64-bit mode.
0F 8D <i>cd</i>	JGE <i>rel32</i>	Valid	Valid	Jump near if greater or equal (SF=OF).

Opcode	Instruction	64-Bit Mode	Compat/ Leg Mode	Description
0F 8C cw	JL <i>rel16</i>	N.S.	Valid	Jump near if less ($SF \neq OF$). Not supported in 64-bit mode.
0F 8C cd	JL <i>rel32</i>	Valid	Valid	Jump near if less ($SF \neq OF$).
0F 8E cw	JLE <i>rel16</i>	N.S.	Valid	Jump near if less or equal ($ZF=1$ or $SF \neq OF$). Not supported in 64-bit mode.
0F 8E cd	JLE <i>rel32</i>	Valid	Valid	Jump near if less or equal ($ZF=1$ or $SF \neq OF$).
0F 86 cw	JNA <i>rel16</i>	N.S.	Valid	Jump near if not above ($CF=1$ or $ZF=1$). Not supported in 64-bit mode.
0F 86 cd	JNA <i>rel32</i>	Valid	Valid	Jump near if not above ($CF=1$ or $ZF=1$).
0F 82 cw	JNAE <i>rel16</i>	N.S.	Valid	Jump near if not above or equal ($CF=1$). Not supported in 64-bit mode.
0F 82 cd	JNAE <i>rel32</i>	Valid	Valid	Jump near if not above or equal ($CF=1$).
0F 83 cw	JNB <i>rel16</i>	N.S.	Valid	Jump near if not below ($CF=0$). Not supported in 64-bit mode.
0F 83 cd	JNB <i>rel32</i>	Valid	Valid	Jump near if not below ($CF=0$).
0F 87 cw	JNBE <i>rel16</i>	N.S.	Valid	Jump near if not below or equal ($CF=0$ and $ZF=0$). Not supported in 64-bit mode.
0F 87 cd	JNBE <i>rel32</i>	Valid	Valid	Jump near if not below or equal ($CF=0$ and $ZF=0$).
0F 83 cw	JNC <i>rel16</i>	N.S.	Valid	Jump near if not carry ($CF=0$). Not supported in 64-bit mode.
0F 83 cd	JNC <i>rel32</i>	Valid	Valid	Jump near if not carry ($CF=0$).
0F 85 cw	JNE <i>rel16</i>	N.S.	Valid	Jump near if not equal ($ZF=0$). Not supported in 64-bit mode.
0F 85 cd	JNE <i>rel32</i>	Valid	Valid	Jump near if not equal ($ZF=0$).
0F 8E cw	JNG <i>rel16</i>	N.S.	Valid	Jump near if not greater ($ZF=1$ or $SF \neq OF$). Not supported in 64-bit mode.
0F 8E cd	JNG <i>rel32</i>	Valid	Valid	Jump near if not greater ($ZF=1$ or $SF \neq OF$).
0F 8C cw	JNGE <i>rel16</i>	N.S.	Valid	Jump near if not greater or equal ($SF \neq OF$). Not supported in 64-bit mode.

Opcode	Instruction	64-Bit Mode	Compat/ Leg Mode	Description
OF 8C <i>cd</i>	JNGE <i>rel32</i>	Valid	Valid	Jump near if not greater or equal (SF≠OF).
OF 8D <i>cw</i>	JNL <i>rel16</i>	N.S.	Valid	Jump near if not less (SF=OF). Not supported in 64-bit mode.
OF 8D <i>cd</i>	JNL <i>rel32</i>	Valid	Valid	Jump near if not less (SF=OF).
OF 8F <i>cw</i>	JNLE <i>rel16</i>	N.S.	Valid	Jump near if not less or equal (ZF=0 and SF=OF). Not supported in 64-bit mode.
OF 8F <i>cd</i>	JNLE <i>rel32</i>	Valid	Valid	Jump near if not less or equal (ZF=0 and SF=OF).
OF 81 <i>cw</i>	JNO <i>rel16</i>	N.S.	Valid	Jump near if not overflow (OF=0). Not supported in 64-bit mode.
OF 81 <i>cd</i>	JNO <i>rel32</i>	Valid	Valid	Jump near if not overflow (OF=0).
OF 8B <i>cw</i>	JNP <i>rel16</i>	N.S.	Valid	Jump near if not parity (PF=0). Not supported in 64-bit mode.
OF 8B <i>cd</i>	JNP <i>rel32</i>	Valid	Valid	Jump near if not parity (PF=0).
OF 89 <i>cw</i>	JNS <i>rel16</i>	N.S.	Valid	Jump near if not sign (SF=0). Not supported in 64-bit mode.
OF 89 <i>cd</i>	JNS <i>rel32</i>	Valid	Valid	Jump near if not sign (SF=0).
OF 85 <i>cw</i>	JNZ <i>rel16</i>	N.S.	Valid	Jump near if not zero (ZF=0). Not supported in 64-bit mode.
OF 85 <i>cd</i>	JNZ <i>rel32</i>	Valid	Valid	Jump near if not zero (ZF=0).
OF 80 <i>cw</i>	JO <i>rel16</i>	N.S.	Valid	Jump near if overflow (OF=1). Not supported in 64-bit mode.
OF 80 <i>cd</i>	JO <i>rel32</i>	Valid	Valid	Jump near if overflow (OF=1).
OF 8A <i>cw</i>	JP <i>rel16</i>	N.S.	Valid	Jump near if parity (PF=1). Not supported in 64-bit mode.
OF 8A <i>cd</i>	JP <i>rel32</i>	Valid	Valid	Jump near if parity (PF=1).
OF 8A <i>cw</i>	JPE <i>rel16</i>	N.S.	Valid	Jump near if parity even (PF=1). Not supported in 64-bit mode.
OF 8A <i>cd</i>	JPE <i>rel32</i>	Valid	Valid	Jump near if parity even (PF=1).
OF 8B <i>cw</i>	JPO <i>rel16</i>	N.S.	Valid	Jump near if parity odd (PF=0). Not supported in 64-bit mode.
OF 8B <i>cd</i>	JPO <i>rel32</i>	Valid	Valid	Jump near if parity odd (PF=0).
OF 88 <i>cw</i>	JS <i>rel16</i>	N.S.	Valid	Jump near if sign (SF=1). Not supported in 64-bit mode.

Opcode	Instruction	64-Bit Mode	Compat/Leg Mode	Description
0F 88 <i>cd</i>	J <i>S rel32</i>	Valid	Valid	Jump near if sign (SF=1).
0F 84 <i>cw</i>	J <i>Z rel16</i>	N.S.	Valid	Jump near if 0 (ZF=1). Not supported in 64-bit mode.
0F 84 <i>cd</i>	J <i>Z rel32</i>	Valid	Valid	Jump near if 0 (ZF=1).

Description

Checks the state of one or more of the status flags in the EFLAGS register (CF, OF, PF, SF, and ZF) and, if the flags are in the specified state (condition), performs a jump to the target instruction specified by the destination operand. A condition code (*cc*) is associated with each instruction to indicate the condition being tested for. If the condition is not satisfied, the jump is not performed and execution continues with the instruction following the *Jcc* instruction.

The target instruction is specified with a relative offset (a signed offset relative to the current value of the instruction pointer in the EIP register). A relative offset (*rel8*, *rel16*, or *rel32*) is generally specified as a label in assembly code, but at the machine code level, it is encoded as a signed, 8-bit or 32-bit immediate value, which is added to the instruction pointer. Instruction coding is most efficient for offsets of –128 to +127. If the operand-size attribute is 16, the upper two bytes of the EIP register are cleared, resulting in a maximum instruction pointer size of 16 bits.

The conditions for each *Jcc* mnemonic are given in the “Description” column of the table on the preceding page. The terms “less” and “greater” are used for comparisons of signed integers and the terms “above” and “below” are used for unsigned integers.

Because a particular state of the status flags can sometimes be interpreted in two ways, two mnemonics are defined for some opcodes. For example, the JA (jump if above) instruction and the JNBE (jump if not below or equal) instruction are alternate mnemonics for the opcode 77H.

The *Jcc* instruction does not support far jumps (jumps to other code segments). When the target for the conditional jump is in a different segment, use the opposite condition from the condition being tested for the *Jcc* instruction, and then access the target with an unconditional far jump (JMP instruction) to the other segment. For example, the following conditional far jump is illegal:

```
JZ FARLABEL;
```

To accomplish this far jump, use the following two instructions:

```
JNZ BEYOND;
JMP FARLABEL;
BEYOND:
```

The JRCXZ, JECXZ and JCXZ instructions differ from other *Jcc* instructions because they do not check status flags. Instead, they check RCX, ECX or CX for 0. The register

checked is determined by the address-size attribute. These instructions are useful when used at the beginning of a loop that terminates with a conditional loop instruction (such as LOOPNE). They can be used to prevent an instruction sequence from entering a loop when RCX, ECX or CX is 0. This would cause the loop to execute 2^{64} , 2^{32} or 64K times (not zero times).

All conditional jumps are converted to code fetches of one or two cache lines, regardless of jump address or cacheability.

In 64-bit mode, operand size is fixed at 64 bits. JMP Short is $RIP = RIP + 8\text{-bit offset sign extended to 64 bits}$. JMP Near is $RIP = RIP + 32\text{-bit offset sign extended to 64-bits}$.

Operation

```
IF condition
  THEN
    tempEIP ← EIP + SignExtend(DEST);
    IF OperandSize = 16
      THEN tempEIP ← tempEIP AND 0000FFFFH;
    FI;
  IF tempEIP is not within code segment limit
    THEN #GP(0);
    ELSE EIP ← tempEIP
  FI;
FI;
```

Protected Mode Exceptions

#GP(0)	If the offset being jumped to is beyond the limits of the CS segment.
#UD	If the LOCK prefix is used.

Real-Address Mode Exceptions

#GP	If the offset being jumped to is beyond the limits of the CS segment or is outside of the effective address space from 0 to FFFFH. This condition can occur if a 32-bit address size override prefix is used.
#UD	If the LOCK prefix is used.

Virtual-8086 Mode Exceptions

Same exceptions as in real address mode.

Compatibility Mode Exceptions

Same exceptions as in protected mode.

64-Bit Mode Exceptions

- | | |
|--------|---------------------------------------------------|
| #GP(0) | If the memory address is in a non-canonical form. |
| #UD | If the LOCK prefix is used. |

JMP—Jump

Opcode	Instruction	64-Bit Mode	Compat/ Leg Mode	Description
EB <i>cb</i>	JMP <i>rel8</i>	Valid	Valid	Jump short, RIP = RIP + 8-bit displacement sign extended to 64-bits
E9 <i>cw</i>	JMP <i>rel16</i>	N.S.	Valid	Jump near, relative, displacement relative to next instruction. Not supported in 64-bit mode.
E9 <i>cd</i>	JMP <i>rel32</i>	Valid	Valid	Jump near, relative, RIP = RIP + 32-bit displacement sign extended to 64-bits
FF <i>/4</i>	JMP <i>r/m16</i>	N.S.	Valid	Jump near, absolute indirect, address = sign-extended <i>r/m16</i> . Not supported in 64-bit mode.
FF <i>/4</i>	JMP <i>r/m32</i>	N.S.	Valid	Jump near, absolute indirect, address = sign-extended <i>r/m32</i> . Not supported in 64-bit mode.
FF <i>/4</i>	JMP <i>r/m64</i>	Valid	N.E.	Jump near, absolute indirect, RIP = 64-Bit offset from register or memory
EA <i>cd</i>	JMP <i>ptr16:16</i>	Inv.	Valid	Jump far, absolute, address given in operand
EA <i>cp</i>	JMP <i>ptr16:32</i>	Inv.	Valid	Jump far, absolute, address given in operand
FF <i>/5</i>	JMP <i>m16:16</i>	Valid	Valid	Jump far, absolute indirect, address given in <i>m16:16</i>
FF <i>/5</i>	JMP <i>m16:32</i>	Valid	Valid	Jump far, absolute indirect, address given in <i>m16:32</i> .
REX.W + FF <i>/5</i>	JMP <i>m16:64</i>	Valid	N.E.	Jump far, absolute indirect, address given in <i>m16:64</i> .

Description

Transfers program control to a different point in the instruction stream without recording return information. The destination (target) operand specifies the address of the instruction being jumped to. This operand can be an immediate value, a general-purpose register, or a memory location.

This instruction can be used to execute four different types of jumps:

- Near jump—A jump to an instruction within the current code segment (the segment currently pointed to by the CS register), sometimes referred to as an intrasegment jump.

- Short jump—A near jump where the jump range is limited to –128 to +127 from the current EIP value.
- Far jump—A jump to an instruction located in a different segment than the current code segment but at the same privilege level, sometimes referred to as an intersegment jump.
- Task switch—A jump to an instruction located in a different task.

A task switch can only be executed in protected mode (see Chapter 7, in the *Intel® 64 and IA-32 Architectures Software Developer's Manual, Volume 3A*, for information on performing task switches with the JMP instruction).

Near and Short Jumps. When executing a near jump, the processor jumps to the address (within the current code segment) that is specified with the target operand. The target operand specifies either an absolute offset (that is an offset from the base of the code segment) or a relative offset (a signed displacement relative to the current value of the instruction pointer in the EIP register). A near jump to a relative offset of 8-bits (*rel8*) is referred to as a short jump. The CS register is not changed on near and short jumps.

An absolute offset is specified indirectly in a general-purpose register or a memory location (*r/m16* or *r/m32*). The operand-size attribute determines the size of the target operand (16 or 32 bits). Absolute offsets are loaded directly into the EIP register. If the operand-size attribute is 16, the upper two bytes of the EIP register are cleared, resulting in a maximum instruction pointer size of 16 bits.

A relative offset (*rel8*, *rel16*, or *rel32*) is generally specified as a label in assembly code, but at the machine code level, it is encoded as a signed 8-, 16-, or 32-bit immediate value. This value is added to the value in the EIP register. (Here, the EIP register contains the address of the instruction following the JMP instruction). When using relative offsets, the opcode (for short vs. near jumps) and the operand-size attribute (for near relative jumps) determines the size of the target operand (8, 16, or 32 bits).

Far Jumps in Real-Address or Virtual-8086 Mode. When executing a far jump in real-address or virtual-8086 mode, the processor jumps to the code segment and offset specified with the target operand. Here the target operand specifies an absolute far address either directly with a pointer (*ptr16:16* or *ptr16:32*) or indirectly with a memory location (*m16:16* or *m16:32*). With the pointer method, the segment and address of the called procedure is encoded in the instruction, using a 4-byte (16-bit operand size) or 6-byte (32-bit operand size) far address immediate. With the indirect method, the target operand specifies a memory location that contains a 4-byte (16-bit operand size) or 6-byte (32-bit operand size) far address. The far address is loaded directly into the CS and EIP registers. If the operand-size attribute is 16, the upper two bytes of the EIP register are cleared.

Far Jumps in Protected Mode. When the processor is operating in protected mode, the JMP instruction can be used to perform the following three types of far jumps:

- A far jump to a conforming or non-conforming code segment.
- A far jump through a call gate.

- A task switch.

(The JMP instruction cannot be used to perform inter-privilege-level far jumps.)

In protected mode, the processor always uses the segment selector part of the far address to access the corresponding descriptor in the GDT or LDT. The descriptor type (code segment, call gate, task gate, or TSS) and access rights determine the type of jump to be performed.

If the selected descriptor is for a code segment, a far jump to a code segment at the same privilege level is performed. (If the selected code segment is at a different privilege level and the code segment is non-conforming, a general-protection exception is generated.) A far jump to the same privilege level in protected mode is very similar to one carried out in real-address or virtual-8086 mode. The target operand specifies an absolute far address either directly with a pointer (*ptr16:16* or *ptr16:32*) or indirectly with a memory location (*m16:16* or *m16:32*). The operand-size attribute determines the size of the offset (16 or 32 bits) in the far address. The new code segment selector and its descriptor are loaded into CS register, and the offset from the instruction is loaded into the EIP register. Note that a call gate (described in the next paragraph) can also be used to perform far call to a code segment at the same privilege level. Using this mechanism provides an extra level of indirection and is the preferred method of making jumps between 16-bit and 32-bit code segments.

When executing a far jump through a call gate, the segment selector specified by the target operand identifies the call gate. (The offset part of the target operand is ignored.) The processor then jumps to the code segment specified in the call gate descriptor and begins executing the instruction at the offset specified in the call gate. No stack switch occurs. Here again, the target operand can specify the far address of the call gate either directly with a pointer (*ptr16:16* or *ptr16:32*) or indirectly with a memory location (*m16:16* or *m16:32*).

Executing a task switch with the JMP instruction is somewhat similar to executing a jump through a call gate. Here the target operand specifies the segment selector of the task gate for the task being switched to (and the offset part of the target operand is ignored). The task gate in turn points to the TSS for the task, which contains the segment selectors for the task's code and stack segments. The TSS also contains the EIP value for the next instruction that was to be executed before the task was suspended. This instruction pointer value is loaded into the EIP register so that the task begins executing again at this next instruction.

The JMP instruction can also specify the segment selector of the TSS directly, which eliminates the indirection of the task gate. See Chapter 7 in *Intel® 64 and IA-32 Architectures Software Developer's Manual, Volume 3A*, for detailed information on the mechanics of a task switch.

Note that when you execute a task switch with a JMP instruction, the nested task flag (NT) is not set in the EFLAGS register and the new TSS's previous task link field is not loaded with the old task's TSS selector. A return to the previous task can thus not be carried out by executing the IRET instruction. Switching tasks with the JMP instruction differs in this regard from the CALL instruction which does set the NT flag

and save the previous task link information, allowing a return to the calling task with an IRET instruction.

In 64-Bit Mode — The instruction's operation size is fixed at 64 bits. If a selector points to a gate, then RIP equals the 64-bit displacement taken from gate; else RIP equals the zero-extended offset from the far pointer referenced in the instruction.

See the summary chart at the beginning of this section for encoding data and limits.

Operation

IF near jump

IF 64-bit Mode

THEN

IF near relative jump

THEN

tempRIP \leftarrow RIP + DEST; (* RIP is instruction following JMP instruction*)

ELSE (* Near absolute jump *)

tempRIP \leftarrow DEST;

FI:

ELSE

IF near relative jump

THEN

tempEIP \leftarrow EIP + DEST; (* EIP is instruction following JMP instruction*)

ELSE (* Near absolute jump *)

tempEIP \leftarrow DEST;

FI:

FI;

IF (IA32_EFER.LMA = 0 or target mode = Compatibility mode)

and tempEIP outside code segment limit

THEN #GP(0); FI

IF 64-bit mode and tempRIP is not canonical

THEN #GP(0);

FI;

IF OperandSize = 32

THEN

EIP \leftarrow tempEIP;

ELSE

IF OperandSize = 16

THEN (* OperandSize = 16 *)

EIP \leftarrow tempEIP AND 0000FFFFH;

ELSE (* OperandSize = 64)

RIP \leftarrow tempRIP;

FI;

FI;

```

FI;
IF far jump and (PE = 0 or (PE = 1 AND VM = 1)) (* Real-address or virtual-8086 mode *)
    THEN
        tempEIP ← DEST(Offset); (* DEST is ptr16:32 or [m16:32] *)
        IF tempEIP is beyond code segment limit
            THEN #GP(0); FI;
        CS ← DEST(segment selector); (* DEST is ptr16:32 or [m16:32] *)
        IF OperandSize = 32
            THEN
                EIP ← tempEIP; (* DEST is ptr16:32 or [m16:32] *)
            ELSE (* OperandSize = 16 *)
                EIP ← tempEIP AND 0000FFFFH; (* Clear upper 16 bits *)
        FI;
FI;

FI;
IF far jump and (PE = 1 and VM = 0)
(* IA-32e mode or protected mode, not virtual-8086 mode *)
    THEN
        IF effective address in the CS, DS, ES, FS, GS, or SS segment is illegal
        or segment selector in target operand NULL
            THEN #GP(0); FI;
        IF segment selector index not within descriptor table limits
            THEN #GP(new selector); FI;
        Read type and access rights of segment descriptor;
        IF (EFER.LMA = 0)
            THEN
                IF segment type is not a conforming or nonconforming code
                segment, call gate, task gate, or TSS
                    THEN #GP(segment selector); FI;
            ELSE
                IF segment type is not a conforming or nonconforming code segment
                call gate
                    THEN #GP(segment selector); FI;
        FI;
        Depending on type and access rights:
            GO TO CONFORMING-CODE-SEGMENT;
            GO TO NONCONFORMING-CODE-SEGMENT;
            GO TO CALL-GATE;
            GO TO TASK-GATE;
            GO TO TASK-STATE-SEGMENT;
    ELSE
        #GP(segment selector);
FI;
CONFORMING-CODE-SEGMENT:
    IF L-Bit = 1 and D-BIT = 1 and IA32_EFER.LMA = 1

```

```

        THEN GP(new code segment selector); FI;
    IF DPL > CPL
        THEN #GP(segment selector); FI;
    IF segment not present
        THEN #NP(segment selector); FI;
    tempEIP ← DEST(Offset);
    IF OperandSize = 16
        THEN tempEIP ← tempEIP AND 0000FFFFH;
    FI;
    IF (IA32_EFER.LMA = 0 or target mode = Compatibility mode) and
    tempEIP outside code segment limit
        THEN #GP(0); FI
    IF tempEIP is non-canonical
        THEN #GP(0); FI;
    CS ← DEST[segment selector]; (* Segment descriptor information also loaded *)
    CS(RPL) ← CPL
    EIP ← tempEIP;
END;

NONCONFORMING-CODE-SEGMENT:
    IF L-Bit = 1 and D-BIT = 1 and IA32_EFER.LMA = 1
        THEN GP(new code segment selector); FI;
    IF (RPL > CPL) OR (DPL ≠ CPL)
        THEN #GP(code segment selector); FI;
    IF segment not present
        THEN #NP(segment selector); FI;
    tempEIP ← DEST(Offset);
    IF OperandSize = 16
        THEN tempEIP ← tempEIP AND 0000FFFFH; FI;
    IF (IA32_EFER.LMA = 0 OR target mode = Compatibility mode)
    and tempEIP outside code segment limit
        THEN #GP(0); FI
    IF tempEIP is non-canonical THEN #GP(0); FI;
    CS ← DEST[segment selector]; (* Segment descriptor information also loaded *)
    CS(RPL) ← CPL;
    EIP ← tempEIP;
END;

CALL-GATE:
    IF call gate DPL < CPL
    or call gate DPL < call gate segment-selector RPL
        THEN #GP(call gate selector); FI;
    IF call gate not present
        THEN #NP(call gate selector); FI;
    IF call gate code-segment selector is NULL

```

```

    THEN #GP(0); FI;
IF call gate code-segment selector index outside descriptor table limits
    THEN #GP(code segment selector); FI;
Read code segment descriptor;
IF code-segment segment descriptor does not indicate a code segment
or code-segment segment descriptor is conforming and DPL > CPL
or code-segment segment descriptor is non-conforming and DPL ≠ CPL
    THEN #GP(code segment selector); FI;
IF IA32_EFER.LMA = 1 and (code-segment descriptor is not a 64-bit code segment
or code-segment segment descriptor has both L-Bit and D-bit set)
    THEN #GP(code segment selector); FI;
IF code segment is not present
    THEN #NP(code-segment selector); FI;
IF instruction pointer is not within code-segment limit
    THEN #GP(0); FI;
tempEIP ← DEST(Offset);
IF GateSize = 16
    THEN tempEIP ← tempEIP AND 0000FFFFH; FI;
IF (IA32_EFER.LMA = 0 OR target mode = Compatibility mode) AND tempEIP
outside code segment limit
    THEN #GP(0); FI;
CS ← DEST[SegmentSelector]; (* Segment descriptor information also loaded *)
CS(RPL) ← CPL;
EIP ← tempEIP;
END;
TASK-GATE:
IF task gate DPL < CPL
or task gate DPL < task gate segment-selector RPL
    THEN #GP(task gate selector); FI;
IF task gate not present
    THEN #NP(gate selector); FI;
Read the TSS segment selector in the task-gate descriptor;
IF TSS segment selector local/global bit is set to local
or index not within GDT limits
or TSS descriptor specifies that the TSS is busy
    THEN #GP(TSS selector); FI;
IF TSS not present
    THEN #NP(TSS selector); FI;
SWITCH-TASKS to TSS;
IF EIP not within code segment limit
    THEN #GP(0); FI;
END;
TASK-STATE-SEGMENT:
IF TSS DPL < CPL

```

```

    or TSS DPL < TSS segment-selector RPL
    or TSS descriptor indicates TSS not available
      THEN #GP(TSS selector); FI;
    IF TSS is not present
      THEN #NP(TSS selector); FI;
    SWITCH-TASKS to TSS;
    IF EIP not within code segment limit
      THEN #GP(0); FI;
END;
```

Flags Affected

All flags are affected if a task switch occurs; no flags are affected if a task switch does not occur.

Protected Mode Exceptions

#GP(0)	<p>If offset in target operand, call gate, or TSS is beyond the code segment limits.</p> <p>If the segment selector in the destination operand, call gate, task gate, or TSS is NULL.</p> <p>If a memory operand effective address is outside the CS, DS, ES, FS, or GS segment limit.</p> <p>If the DS, ES, FS, or GS register is used to access memory and it contains a NULL segment selector.</p>
#GP(selector)	<p>If the segment selector index is outside descriptor table limits.</p> <p>If the segment descriptor pointed to by the segment selector in the destination operand is not for a conforming-code segment, nonconforming-code segment, call gate, task gate, or task state segment.</p> <p>If the DPL for a nonconforming-code segment is not equal to the CPL</p> <p>(When not using a call gate.) If the RPL for the segment's segment selector is greater than the CPL.</p> <p>If the DPL for a conforming-code segment is greater than the CPL.</p> <p>If the DPL from a call-gate, task-gate, or TSS segment descriptor is less than the CPL or than the RPL of the call-gate, task-gate, or TSS's segment selector.</p> <p>If the segment descriptor for selector in a call gate does not indicate it is a code segment.</p> <p>If the segment descriptor for the segment selector in a task gate does not indicate an available TSS.</p>

	If the segment selector for a TSS has its local/global bit set for local.
	If a TSS segment descriptor specifies that the TSS is busy or not available.
#SS(0)	If a memory operand effective address is outside the SS segment limit.
#NP (selector)	If the code segment being accessed is not present.
	If call gate, task gate, or TSS not present.
#PF(fault-code)	If a page fault occurs.
#AC(0)	If alignment checking is enabled and an unaligned memory reference is made while the current privilege level is 3. (Only occurs when fetching target from memory.)
#UD	If the LOCK prefix is used.

Real-Address Mode Exceptions

#GP	If a memory operand effective address is outside the CS, DS, ES, FS, or GS segment limit.
	If a memory operand effective address is outside the CS, DS, ES, FS, or GS segment limit.
#SS	If a memory operand effective address is outside the SS segment limit.
#UD	If the LOCK prefix is used.

Virtual-8086 Mode Exceptions

#GP(0)	If the target operand is beyond the code segment limits.
	If a memory operand effective address is outside the CS, DS, ES, FS, or GS segment limit.
#SS(0)	If a memory operand effective address is outside the SS segment limit.
#PF(fault-code)	If a page fault occurs.
#AC(0)	If alignment checking is enabled and an unaligned memory reference is made. (Only occurs when fetching target from memory.)
#UD	If the LOCK prefix is used.

Compatibility Mode Exceptions

Same as 64-bit mode exceptions.

64-Bit Mode Exceptions

#GP(0)	If a memory address is non-canonical.
--------	---------------------------------------

	If target offset in destination operand is non-canonical.
	If target offset in destination operand is beyond the new code segment limit.
	If the segment selector in the destination operand is NULL.
	If the code segment selector in the 64-bit gate is NULL.
#GP(selector)	If the code segment or 64-bit call gate is outside descriptor table limits.
	If the code segment or 64-bit call gate overlaps non-canonical space.
	If the segment descriptor from a 64-bit call gate is in non-canonical space.
	If the segment descriptor pointed to by the segment selector in the destination operand is not for a conforming-code segment, nonconforming-code segment, 64-bit call gate.
	If the segment descriptor pointed to by the segment selector in the destination operand is a code segment, and has both the D-bit and the L-bit set.
	If the DPL for a nonconforming-code segment is not equal to the CPL, or the RPL for the segment's segment selector is greater than the CPL.
	If the DPL for a conforming-code segment is greater than the CPL.
	If the DPL from a 64-bit call-gate is less than the CPL or than the RPL of the 64-bit call-gate.
	If the upper type field of a 64-bit call gate is not 0x0.
	If the segment selector from a 64-bit call gate is beyond the descriptor table limits.
	If the code segment descriptor pointed to by the selector in the 64-bit gate doesn't have the L-bit set and the D-bit clear.
	If the segment descriptor for a segment selector from the 64-bit call gate does not indicate it is a code segment.
	If the code segment is non-confirming and $CPL \neq DPL$.
	If the code segment is confirming and $CPL < DPL$.
#NP(selector)	If a code segment or 64-bit call gate is not present.
#UD	(64-bit mode only) If a far jump is direct to an absolute address in memory.
	If the LOCK prefix is used.
#PF(fault-code)	If a page fault occurs.
#AC(0)	If alignment checking is enabled and an unaligned memory reference is made while the current privilege level is 3.

LAHF—Load Status Flags into AH Register

Opcode	Instruction	64-Bit Mode	Compat/Leg Mode	Description
9F	LAHF	Invalid*	Valid	Load: AH ← EFLAGS(SF:ZF:0:AF:0:PF:1:CF).

NOTES:

* Valid in specific steppings. See Description section.

Description

This instruction executes as described above in compatibility mode and legacy mode. It is valid in 64-bit mode only if CPUID.80000001H:ECX.LAHF-SAHF[bit 0] = 1.

Operation

```
IF 64-Bit Mode
  THEN
    IF CPUID.80000001H:ECX.LAHF-SAHF[bit 0] = 1;
      THEN AH ← RFLAGS(SF:ZF:0:AF:0:PF:1:CF);
      ELSE #UD;
    FI;
  ELSE
    AH ← EFLAGS(SF:ZF:0:AF:0:PF:1:CF);
  FI;
```

Flags Affected

None. The state of the flags in the EFLAGS register is not affected.

Protected Mode Exceptions

#UD If the LOCK prefix is used.

Real-Address Mode Exceptions

Same exceptions as in protected mode.

Virtual-8086 Mode Exceptions

Same exceptions as in protected mode.

Compatibility Mode Exceptions

Same exceptions as in protected mode.

64-Bit Mode Exceptions

#UD If CPUID.80000001H:ECX.LAHF-SAHF[bit 0] = 0.
 If the LOCK prefix is used.

LAR—Load Access Rights Byte

Opcode	Instruction	64-Bit Mode	Compat/ Leg Mode	Description
OF 02 /r	LAR <i>r16, r16/m16</i>	Valid	Valid	<i>r16</i> ← <i>r16/m16</i> masked by FF00H.
OF 02 /r	LAR <i>r32, r32/m16</i> ¹	Valid	Valid	<i>r32</i> ← <i>r32/m16</i> masked by 00FxFF00H
REX.W + OF 02 /r	LAR <i>r64, r32/m16</i> ¹	Valid	N.E.	<i>r64</i> ← <i>r32/m16</i> masked by 00FxFF00H and zero extended

NOTES:

1. For all loads (regardless of source or destination sizing) only bits 16-0 are used. Other bits are ignored.

Description

Loads the access rights from the segment descriptor specified by the second operand (source operand) into the first operand (destination operand) and sets the ZF flag in the flag register. The source operand (which can be a register or a memory location) contains the segment selector for the segment descriptor being accessed. If the source operand is a memory address, only 16 bits of data are accessed. The destination operand is a general-purpose register.

The processor performs access checks as part of the loading process. Once loaded in the destination register, software can perform additional checks on the access rights information.

When the operand size is 32 bits, the access rights for a segment descriptor include the type and DPL fields and the S, P, AVL, D/B, and G flags, all of which are located in the second doubleword (bytes 4 through 7) of the segment descriptor. The doubleword is masked by 00FxFF00H before it is loaded into the destination operand. When the operand size is 16 bits, the access rights include the type and DPL fields. Here, the two lower-order bytes of the doubleword are masked by FF00H before being loaded into the destination operand.

This instruction performs the following checks before it loads the access rights in the destination register:

- Checks that the segment selector is not NULL.
- Checks that the segment selector points to a descriptor that is within the limits of the GDT or LDT being accessed
- Checks that the descriptor type is valid for this instruction. All code and data segment descriptors are valid for (can be accessed with) the LAR instruction. The valid system segment and gate descriptor types are given in Table 3-65.

- If the segment is not a conforming code segment, it checks that the specified segment descriptor is visible at the CPL (that is, if the CPL and the RPL of the segment selector are less than or equal to the DPL of the segment selector).

If the segment descriptor cannot be accessed or is an invalid type for the instruction, the ZF flag is cleared and no access rights are loaded in the destination operand.

The LAR instruction can only be executed in protected mode and IA-32e mode.

In 64-bit mode, the instruction's default operation size is 32 bits. Use of the REX.W prefix permits access to 64-bit registers as destination.

When the destination operand size is 64 bits, the access rights are loaded from the second doubleword (bytes 4 through 7) of the segment descriptor. The doubleword is masked by 00FXFF00H and zero extended to 64 bits before it is loaded into the destination operand.

Table 3-65. Segment and Gate Types

Type	Protected Mode		IA-32e Mode	
	Name	Valid	Name	Valid
0	Reserved	No	Reserved	No
1	Available 16-bit TSS	Yes	Reserved	No
2	LDT	Yes	LDT	No
3	Busy 16-bit TSS	Yes	Reserved	No
4	16-bit call gate	Yes	Reserved	No
5	16-bit/32-bit task gate	Yes	Reserved	No
6	16-bit interrupt gate	No	Reserved	No
7	16-bit trap gate	No	Reserved	No
8	Reserved	No	Reserved	No
9	Available 32-bit TSS	Yes	Available 64-bit TSS	Yes
A	Reserved	No	Reserved	No
B	Busy 32-bit TSS	Yes	Busy 64-bit TSS	Yes
C	32-bit call gate	Yes	64-bit call gate	Yes
D	Reserved	No	Reserved	No
E	32-bit interrupt gate	No	64-bit interrupt gate	No
F	32-bit trap gate	No	64-bit trap gate	No

Operation

IF Offset(SRC) > descriptor table limit
THEN

```

ZF = 0;
ELSE

IF SegmentDescriptor(Type) ≠ conforming code segment
and (CPL > DPL) or (RPL > DPL)
or segment type is not valid for instruction
  THEN
    ZF ← 0
  ELSE

    TEMP ← Read segment descriptor ;
    IF OperandSize = 64
      THEN
        DEST ← (ACCESSRIGHTWORD(TEMP) AND 00000000_00FxFF00H);
      ELSE (* OperandSize = 32*)
        DEST ← (ACCESSRIGHTWORD(TEMP) AND 00FxFF00H);
      ELSE (* OperandSize = 16 *)
        DEST ← (ACCESSRIGHTWORD(TEMP) AND FFO0H);
    FI;
  FI;
FI;

```

Flags Affected

The ZF flag is set to 1 if the access rights are loaded successfully; otherwise, it is set to 0.

Protected Mode Exceptions

#GP(0)	If a memory operand effective address is outside the CS, DS, ES, FS, or GS segment limit. If the DS, ES, FS, or GS register is used to access memory and it contains a NULL segment selector.
#SS(0)	If a memory operand effective address is outside the SS segment limit.
#PF(fault-code)	If a page fault occurs.
#AC(0)	If alignment checking is enabled and the memory operand effective address is unaligned while the current privilege level is 3.
#UD	If the LOCK prefix is used.

Real-Address Mode Exceptions

#UD	The LAR instruction is not recognized in real-address mode.
-----	-------------------------------------------------------------

Virtual-8086 Mode Exceptions

#UD The LAR instruction cannot be executed in virtual-8086 mode.

Compatibility Mode Exceptions

Same exceptions as in protected mode.

64-Bit Mode Exceptions

- #SS(0) If the memory operand effective address referencing the SS segment is in a non-canonical form.
- #GP(0) If the memory operand effective address is in a non-canonical form.
- #PF(fault-code) If a page fault occurs.
- #AC(0) If alignment checking is enabled and the memory operand effective address is unaligned while the current privilege level is 3.
- #UD If the LOCK prefix is used.

LDDQU—Load Unaligned Integer 128 Bits

Opcode	Instruction	64-Bit Mode	Compat/ Leg Mode	Description
F2 0F F0 /r	LDDQU <i>xmm1</i> , <i>mem</i>	Valid	Valid	Load unaligned data from <i>mem</i> and return double quadword in <i>xmm1</i> .

Description

The instruction is *functionally similar* to MOVDQU *xmm*, *m128* for loading from memory. That is: 16 bytes of data starting at an address specified by the source memory operand (second operand) are fetched from memory and placed in a destination register (first operand). The source operand need not be aligned on a 16-byte boundary. Up to 32 bytes may be loaded from memory; this is implementation dependent.

This instruction may improve performance relative to MOVDQU if the source operand crosses a cache line boundary. In situations that require the data loaded by LDDQU be modified and stored to the same location, use MOVDQU or MOVDQA instead of LDDQU. To move a double quadword to or from memory locations that are known to be aligned on 16-byte boundaries, use the MOVDQA instruction.

Implementation Notes

- If the source is aligned to a 16-byte boundary, based on the implementation, the 16 bytes may be loaded more than once. For that reason, the usage of LDDQU should be avoided when using uncached or write-combining (WC) memory regions. For uncached or WC memory regions, keep using MOVDQU.
- This instruction is a replacement for MOVDQU (load) in situations where cache line splits significantly affect performance. It should not be used in situations where store-load forwarding is performance critical. If performance of store-load forwarding is critical to the application, use MOVDQA store-load pairs when data is 128-bit aligned or MOVDQU store-load pairs when data is 128-bit unaligned.
- If the memory address is not aligned on 16-byte boundary, some implementations may load up to 32 bytes and return 16 bytes in the destination. Some processor implementations may issue multiple loads to access the appropriate 16 bytes. Developers of multi-threaded or multi-processor software should be aware that on these processors the loads will be performed in a non-atomic way.

In 64-bit mode, use of the REX.R prefix permits this instruction to access additional registers (XMM8-XMM15).

Operation

```
xmm[127:0] = m128;
```

Intel C/C++ Compiler Intrinsic EquivalentLDDQU `__m128i _mm_lddqu_si128(__m128i const *p)`**Numeric Exceptions**

None.

Protected Mode Exceptions

#GP(0)	For an illegal memory operand effective address in the CS, DS, ES, FS or GS segments.
#SS(0)	For an illegal address in the SS segment.
#PF(fault-code)	For a page fault.
#NM	If CR0.TS[bit 3] = 1.
#UD	If CR4.OSFXSR[bit 9] = 0. If CR0.EM[bit 2] = 1. If CPUID.01H: ECX.SSE3[bit 0] = 0. If the LOCK prefix is used.
#AC(0)	If alignment checking is enabled and an unaligned memory reference is made while the current privilege level is 3.

Real Address Mode Exceptions

GP(0)	If any part of the operand would lie outside of the effective address space from 0 to 0FFFFH.
#NM	If CR0.TS[bit 3] = 1.
#UD	If CR0.EM[bit 2] = 1. If CR4.OSFXSR[bit 9] = 0. If CPUID.01H: ECX.SSE3[bit 0] = 0. If the LOCK prefix is used.

Virtual 8086 Mode Exceptions

GP(0)	If any part of the operand would lie outside of the effective address space from 0 to 0FFFFH.
#NM	If CR0.TS[bit 3] = 1.
#UD	If CR0.EM[bit 2] = 1. If CR4.OSFXSR[bit 9] = 0. If CPUID.01H: ECX.SSE3[bit 0] = 0. If the LOCK prefix is used.
#PF(fault-code)	For a page fault.
#AC(0)	If alignment checking is enabled and an unaligned memory reference is made.

Compatibility Mode Exceptions

Same exceptions as in protected mode.

64-Bit Mode Exceptions

#SS(0)	If a memory address referencing the SS segment is in a non-canonical form.
#GP(0)	If the memory address is in a non-canonical form.
#NM	If CR0.TS[bit 3] = 1.
#UD	If CR0.EM[bit 2] = 1. If CR4.OSFXSR[bit 9] = 0. If CPUID.01H: ECX.SSE3[bit 0] = 0.
#PF(fault-code)	If the LOCK prefix is used. If a page fault occurs.

LDMXCSR—Load MXCSR Register

Opcode	Instruction	64-Bit Mode	Compat/Leg Mode	Description
0F,AE,12	LDMXCSR <i>m32</i>	Valid	Valid	Load MXCSR register from <i>m32</i> .

Description

Loads the source operand into the MXCSR control/status register. The source operand is a 32-bit memory location. See “MXCSR Control and Status Register” in Chapter 10, of the *Intel® 64 and IA-32 Architectures Software Developer’s Manual, Volume 1*, for a description of the MXCSR register and its contents.

The LDMXCSR instruction is typically used in conjunction with the STMXCSR instruction, which stores the contents of the MXCSR register in memory.

The default MXCSR value at reset is 1F80H.

If a LDMXCSR instruction clears a SIMD floating-point exception mask bit and sets the corresponding exception flag bit, a SIMD floating-point exception will not be immediately generated. The exception will be generated only upon the execution of the next SSE or SSE2 instruction that causes that particular SIMD floating-point exception to be reported.

This instruction’s operation is the same in non-64-bit modes and 64-bit mode.

Operation

$\text{MXCSR} \leftarrow m32;$

C/C++ Compiler Intrinsic Equivalent

`_mm_setcsr(unsigned int i)`

Numeric Exceptions

None.

Protected Mode Exceptions

#GP(0)	For an illegal memory operand effective address in the CS, DS, ES, FS, or GS segments.
	For an attempt to set reserved bits in MXCSR.
#SS(0)	For an illegal address in the SS segment.
#PF(fault-code)	For a page fault.
#NM	If CR0.TS[bit 3] = 1.
#UD	If CR0.EM[bit 2] = 1.
	If CR4.OSFXSR[bit 9] = 0.

	If CPUID.01H: EDX.SSE[bit 25] = 0.
	If the LOCK prefix is used.
#AC(0)	If alignment checking is enabled and an unaligned memory reference is made while the current privilege level is 3.

Real Address Mode Exceptions

GP(0)	If any part of the operand would lie outside of the effective address space from 0 to FFFFH.
	For an attempt to set reserved bits in MXCSR.
#NM	If CR0.TS[bit 3] = 1.
#UD	If CR0.EM[bit 2] = 1.
	If CR4.OSFXSR[bit 9] = 0.
	If CPUID.01H: EDX.SSE[bit 25] = 0.
	If the LOCK prefix is used.

Virtual 8086 Mode Exceptions

Same exceptions as in real address mode.

#PF(fault-code)	For a page fault.
#AC(0)	If alignment checking is enabled and an unaligned memory reference is made.
	If the LOCK prefix is used.

Compatibility Mode Exceptions

Same exceptions as in protected mode.

64-Bit Mode Exceptions

#SS(0)	If a memory address referencing the SS segment is in a non-canonical form.
#GP(0)	If the memory address is in a non-canonical form.
	For an attempt to set reserved bits in MXCSR.
#PF(fault-code)	For a page fault.
#NM	If CR0.TS[bit 3] = 1.
#UD	If CR0.EM[bit 2] = 1.
	If CR4.OSFXSR[bit 9] = 0.
	If CPUID.01H: EDX.SSE[bit 25] = 0.
	If the LOCK prefix is used.
#AC(0)	If alignment checking is enabled and an unaligned memory reference is made while the current privilege level is 3.

LDS/LES/LFS/LGS/LSS—Load Far Pointer

Opcode	Instruction	64-Bit Mode	Compat/ Leg Mode	Description
C5 /r	LDS <i>r16,m16:16</i>	Invalid	Valid	Load DS: <i>r16</i> with far pointer from memory.
C5 /r	LDS <i>r32,m16:32</i>	Invalid	Valid	Load DS: <i>r32</i> with far pointer from memory.
0F B2 /r	LSS <i>r16,m16:16</i>	Valid	Valid	Load SS: <i>r16</i> with far pointer from memory.
0F B2 /r	LSS <i>r32,m16:32</i>	Valid	Valid	Load SS: <i>r32</i> with far pointer from memory.
REX + 0F B2 /r	LSS <i>r64,m16:64</i>	Valid	N.E.	Load SS: <i>r64</i> with far pointer from memory.
C4 /r	LES <i>r16,m16:16</i>	Invalid	Valid	Load ES: <i>r16</i> with far pointer from memory.
C4 /r	LES <i>r32,m16:32</i>	Invalid	Valid	Load ES: <i>r32</i> with far pointer from memory.
0F B4 /r	LFS <i>r16,m16:16</i>	Valid	Valid	Load FS: <i>r16</i> with far pointer from memory.
0F B4 /r	LFS <i>r32,m16:32</i>	Valid	Valid	Load FS: <i>r32</i> with far pointer from memory.
REX + 0F B4 /r	LFS <i>r64,m16:64</i>	Valid	N.E.	Load FS: <i>r64</i> with far pointer from memory.
0F B5 /r	LGS <i>r16,m16:16</i>	Valid	Valid	Load GS: <i>r16</i> with far pointer from memory.
0F B5 /r	LGS <i>r32,m16:32</i>	Valid	Valid	Load GS: <i>r32</i> with far pointer from memory.
REX + 0F B5 /r	LGS <i>r64,m16:64</i>	Valid	N.E.	Load GS: <i>r64</i> with far pointer from memory.

Description

Loads a far pointer (segment selector and offset) from the second operand (source operand) into a segment register and the first operand (destination operand). The source operand specifies a 48-bit or a 32-bit pointer in memory depending on the current setting of the operand-size attribute (32 bits or 16 bits, respectively). The instruction opcode and the destination operand specify a segment register/general-purpose register pair. The 16-bit segment selector from the source operand is loaded into the segment register specified with the opcode (DS, SS, ES, FS, or GS). The 32-bit or 16-bit offset is loaded into the register specified with the destination operand.

If one of these instructions is executed in protected mode, additional information from the segment descriptor pointed to by the segment selector in the source operand is loaded in the hidden part of the selected segment register.

Also in protected mode, a NULL selector (values 0000 through 0003) can be loaded into DS, ES, FS, or GS registers without causing a protection exception. (Any subsequent reference to a segment whose corresponding segment register is loaded with a NULL selector, causes a general-protection exception (#GP) and no memory reference to the segment occurs.)

In 64-bit mode, the instruction's default operation size is 32 bits. Using a REX prefix in the form of REX.W promotes operation to specify a source operand referencing an 80-bit pointer (16-bit selector, 64-bit offset) in memory. Using a REX prefix in the form of REX.R permits access to additional registers (R8-R15). See the summary chart at the beginning of this section for encoding data and limits.

Operation

64-BIT_MODE

IF SS is loaded

THEN

IF SegmentSelector = NULL and (RPL = 3) or
(RPL ≠ 3 and RPL ≠ CPL)

THEN #GP(0);

ELSE IF descriptor is in non-canonical space

THEN #GP(0); FI;

ELSE IF Segment selector index is not within descriptor table limits
or segment selector RPL ≠ CPL

or access rights indicate nonwritable data segment
or DPL ≠ CPL

THEN #GP(selector); FI;

ELSE IF Segment marked not present

THEN #SS(selector); FI;

FI;

SS ← SegmentSelector(SRC);

SS ← SegmentDescriptor([SRC]);

ELSE IF attempt to load DS, or ES

THEN #UD;

ELSE IF FS, or GS is loaded with non-NULl segment selector

THEN IF Segment selector index is not within descriptor table limits

or access rights indicate segment neither data nor readable code segment

or segment is data or nonconforming-code segment

and (RPL > DPL or CPL > DPL)

THEN #GP(selector); FI;

ELSE IF Segment marked not present

THEN #NP(selector); FI;

```

    FI;
    SegmentRegister ← SegmentSelector(SRC) ;
    SegmentRegister ← SegmentDescriptor([SRC]);
  FI;
ELSE IF FS, or GS is loaded with a NULL selector:
  THEN
    SegmentRegister ← NULLSelector;
    SegmentRegister(DescriptorValidBit) ← 0; FI; (* Hidden flag;
      not accessible by software *)
  FI;
DEST ← Offset(SRC);

PROTECTED MODE OR COMPATIBILITY MODE;
IF SS is loaded
  THEN
    IF SegmentSelector = NULL
      THEN #GP(0);
    ELSE IF Segment selector index is not within descriptor table limits
      or segment selector RPL ≠ CPL
      or access rights indicate nonwritable data segment
      or DPL ≠ CPL
      THEN #GP(selector); FI;
    ELSE IF Segment marked not present
      THEN #SS(selector); FI;
    FI;
    SS ← SegmentSelector(SRC);
    SS ← SegmentDescriptor([SRC]);
  ELSE IF DS, ES, FS, or GS is loaded with non-NULL segment selector
    THEN IF Segment selector index is not within descriptor table limits
      or access rights indicate segment neither data nor readable code segment
      or segment is data or nonconforming-code segment
      and (RPL > DPL or CPL > DPL)
      THEN #GP(selector); FI;
    ELSE IF Segment marked not present
      THEN #NP(selector); FI;
    FI;
    SegmentRegister ← SegmentSelector(SRC) AND RPL;
    SegmentRegister ← SegmentDescriptor([SRC]);
  FI;
ELSE IF DS, ES, FS, or GS is loaded with a NULL selector:
  THEN
    SegmentRegister ← NULLSelector;
    SegmentRegister(DescriptorValidBit) ← 0; FI; (* Hidden flag;
      not accessible by software *)

```

FI;
 DEST ← Offset(SRC);

Real-Address or Virtual-8086 Mode

SegmentRegister ← SegmentSelector(SRC); FI;
 DEST ← Offset(SRC);

Flags Affected

None.

Protected Mode Exceptions

#UD	If source operand is not a memory location. If the LOCK prefix is used.
#GP(0)	If a NULL selector is loaded into the SS register. If a memory operand effective address is outside the CS, DS, ES, FS, or GS segment limit. If the DS, ES, FS, or GS register is used to access memory and it contains a NULL segment selector.
#GP(selector)	If the SS register is being loaded and any of the following is true: the segment selector index is not within the descriptor table limits, the segment selector RPL is not equal to CPL, the segment is a non-writable data segment, or DPL is not equal to CPL. If the DS, ES, FS, or GS register is being loaded with a non-NULL segment selector and any of the following is true: the segment selector index is not within descriptor table limits, the segment is neither a data nor a readable code segment, or the segment is a data or nonconforming-code segment and both RPL and CPL are greater than DPL.
#SS(0)	If a memory operand effective address is outside the SS segment limit.
#SS(selector)	If the SS register is being loaded and the segment is marked not present.
#NP(selector)	If DS, ES, FS, or GS register is being loaded with a non-NULL segment selector and the segment is marked not present.
#PF(fault-code)	If a page fault occurs.
#AC(0)	If alignment checking is enabled and an unaligned memory reference is made while the current privilege level is 3.

Real-Address Mode Exceptions

#GP	If a memory operand effective address is outside the CS, DS, ES, FS, or GS segment limit.
-----	-------------------------------------------------------------------------------------------

- #SS If a memory operand effective address is outside the SS segment limit.
- #UD If source operand is not a memory location.
If the LOCK prefix is used.

Virtual-8086 Mode Exceptions

- #UD If source operand is not a memory location.
If the LOCK prefix is used.
- #GP(0) If a memory operand effective address is outside the CS, DS, ES, FS, or GS segment limit.
- #SS(0) If a memory operand effective address is outside the SS segment limit.
- #PF(fault-code) If a page fault occurs.
- #AC(0) If alignment checking is enabled and an unaligned memory reference is made.

Compatibility Mode Exceptions

Same exceptions as in protected mode.

64-Bit Mode Exceptions

- #GP(0) If the memory address is in a non-canonical form.
If a NULL selector is attempted to be loaded into the SS register in compatibility mode.
If a NULL selector is attempted to be loaded into the SS register in CPL3 and 64-bit mode.
If a NULL selector is attempted to be loaded into the SS register in non-CPL3 and 64-bit mode where its RPL is not equal to CPL.
- #GP(Selector) If the FS, or GS register is being loaded with a non-NULL segment selector and any of the following is true: the segment selector index is not within descriptor table limits, the memory address of the descriptor is non-canonical, the segment is neither a data nor a readable code segment, or the segment is a data or nonconforming-code segment and both RPL and CPL are greater than DPL.
If the SS register is being loaded and any of the following is true: the segment selector index is not within the descriptor table limits, the memory address of the descriptor is non-canonical, the segment selector RPL is not equal to CPL, the segment is a nonwritable data segment, or DPL is not equal to CPL.
- #SS(0) If a memory operand effective address is non-canonical
- #SS(Selector) If the SS register is being loaded and the segment is marked not present.

#NP(selector)	If FS, or GS register is being loaded with a non-NULL segment selector and the segment is marked not present.
#PF(fault-code)	If a page fault occurs.
#AC(0)	If alignment checking is enabled and an unaligned memory reference is made while the current privilege level is 3.
#UD	If source operand is not a memory location. If the LOCK prefix is used.

LEA—Load Effective Address

Opcode	Instruction	64-Bit Mode	Compat/ Leg Mode	Description
8D /r	LEA <i>r16,m</i>	Valid	Valid	Store effective address for <i>m</i> in register <i>r16</i> .
8D /r	LEA <i>r32,m</i>	Valid	Valid	Store effective address for <i>m</i> in register <i>r32</i> .
REX.W + 8D /r	LEA <i>r64,m</i>	Valid	N.E.	Store effective address for <i>m</i> in register <i>r64</i> .

Description

Computes the effective address of the second operand (the source operand) and stores it in the first operand (destination operand). The source operand is a memory address (offset part) specified with one of the processors addressing modes; the destination operand is a general-purpose register. The address-size and operand-size attributes affect the action performed by this instruction, as shown in the following table. The operand-size attribute of the instruction is determined by the chosen register; the address-size attribute is determined by the attribute of the code segment.

Table 3-66. Non-64-bit Mode LEA Operation with Address and Operand Size Attributes

Operand Size	Address Size	Action Performed
16	16	16-bit effective address is calculated and stored in requested 16-bit register destination.
16	32	32-bit effective address is calculated. The lower 16 bits of the address are stored in the requested 16-bit register destination.
32	16	16-bit effective address is calculated. The 16-bit address is zero-extended and stored in the requested 32-bit register destination.
32	32	32-bit effective address is calculated and stored in the requested 32-bit register destination.

Different assemblers may use different algorithms based on the size attribute and symbolic reference of the source operand.

In 64-bit mode, the instruction's destination operand is governed by operand size attribute, the default operand size is 32 bits. Address calculation is governed by address size attribute, the default address size is 64-bits. In 64-bit mode, address size of 16 bits is not encodable. See Table 3-67.

Table 3-67. 64-bit Mode LEA Operation with Address and Operand Size Attributes

Operand Size	Address Size	Action Performed
16	32	32-bit effective address is calculated (using 67H prefix). The lower 16 bits of the address are stored in the requested 16-bit register destination (using 66H prefix).
16	64	64-bit effective address is calculated (default address size). The lower 16 bits of the address are stored in the requested 16-bit register destination (using 66H prefix).
32	32	32-bit effective address is calculated (using 67H prefix) and stored in the requested 32-bit register destination.
32	64	64-bit effective address is calculated (default address size) and the lower 32 bits of the address are stored in the requested 32-bit register destination.
64	32	32-bit effective address is calculated (using 67H prefix), zero-extended to 64-bits, and stored in the requested 64-bit register destination (using REX.W).
64	64	64-bit effective address is calculated (default address size) and all 64-bits of the address are stored in the requested 64-bit register destination (using REX.W).

Operation

```

IF OperandSize = 16 and AddressSize = 16
  THEN
    DEST ← EffectiveAddress(SRC); (* 16-bit address *)
  ELSE IF OperandSize = 16 and AddressSize = 32
    THEN
      temp ← EffectiveAddress(SRC); (* 32-bit address *)
      DEST ← temp[0:15]; (* 16-bit address *)
    FI;
  ELSE IF OperandSize = 32 and AddressSize = 16
    THEN
      temp ← EffectiveAddress(SRC); (* 16-bit address *)
      DEST ← ZeroExtend(temp); (* 32-bit address *)
    FI;
  ELSE IF OperandSize = 32 and AddressSize = 32
    THEN
      DEST ← EffectiveAddress(SRC); (* 32-bit address *)
    FI;
  ELSE IF OperandSize = 16 and AddressSize = 64
    THEN
      temp ← EffectiveAddress(SRC); (* 64-bit address *)

```

```

        DEST ← temp[0:15]; (* 16-bit address *)
    FI;
ELSE IF OperandSize = 32 and AddressSize = 64
    THEN
        temp ← EffectiveAddress(SRC); (* 64-bit address *)
        DEST ← temp[0:31]; (* 16-bit address *)
    FI;
ELSE IF OperandSize = 64 and AddressSize = 64
    THEN
        DEST ← EffectiveAddress(SRC); (* 64-bit address *)
    FI;
FI;

```

Flags Affected

None.

Protected Mode Exceptions

#UD If source operand is not a memory location.
 If the LOCK prefix is used.

Real-Address Mode Exceptions

Same exceptions as in protected mode.

Virtual-8086 Mode Exceptions

Same exceptions as in protected mode.

Compatibility Mode Exceptions

Same exceptions as in protected mode.

64-Bit Mode Exceptions

Same exceptions as in protected mode.

LEAVE—High Level Procedure Exit

Opcode	Instruction	64-Bit Mode	Compat/Leg Mode	Description
C9	LEAVE	Valid	Valid	Set SP to BP, then pop BP.
C9	LEAVE	N.E.	Valid	Set ESP to EBP, then pop EBP.
C9	LEAVE	Valid	N.E.	Set RSP to RBP, then pop RBP.

Description

Releases the stack frame set up by an earlier ENTER instruction. The LEAVE instruction copies the frame pointer (in the EBP register) into the stack pointer register (ESP), which releases the stack space allocated to the stack frame. The old frame pointer (the frame pointer for the calling procedure that was saved by the ENTER instruction) is then popped from the stack into the EBP register, restoring the calling procedure's stack frame.

A RET instruction is commonly executed following a LEAVE instruction to return program control to the calling procedure.

See “Procedure Calls for Block-Structured Languages” in Chapter 7 of the *Intel® 64 and IA-32 Architectures Software Developer’s Manual, Volume 1*, for detailed information on the use of the ENTER and LEAVE instructions.

In 64-bit mode, the instruction’s default operation size is 64 bits; 32-bit operation cannot be encoded. See the summary chart at the beginning of this section for encoding data and limits.

Operation

IF StackAddressSize = 32

THEN

ESP ← EBP;

ELSE IF StackAddressSize = 64

THEN RSP ← RBP; FI;

ELSE IF StackAddressSize = 16

THEN SP ← BP; FI;

FI;

IF OperandSize = 32

THEN EBP ← Pop();

ELSE IF OperandSize = 64

THEN RBP ← Pop(); FI;

ELSE IF OperandSize = 16

THEN BP ← Pop(); FI;

FI;

Flags Affected

None.

Protected Mode Exceptions

#SS(0)	If the EBP register points to a location that is not within the limits of the current stack segment.
#PF(fault-code)	If a page fault occurs.
#AC(0)	If alignment checking is enabled and an unaligned memory reference is made while the current privilege level is 3.
#UD	If the LOCK prefix is used.

Real-Address Mode Exceptions

#GP	If the EBP register points to a location outside of the effective address space from 0 to FFFFH.
#UD	If the LOCK prefix is used.

Virtual-8086 Mode Exceptions

#GP(0)	If the EBP register points to a location outside of the effective address space from 0 to FFFFH.
#PF(fault-code)	If a page fault occurs.
#AC(0)	If alignment checking is enabled and an unaligned memory reference is made.
#UD	If the LOCK prefix is used.

Compatibility Mode Exceptions

Same exceptions as in protected mode.

64-Bit Mode Exceptions

#SS(0)	If the stack address is in a non-canonical form.
#AC(0)	If alignment checking is enabled and an unaligned memory reference is made while the current privilege level is 3.
#UD	If the LOCK prefix is used.

LFENCE—Load Fence

Opcode	Instruction	64-Bit Mode	Compat/ Leg Mode	Description
OF AE /5	LFENCE	Valid	Valid	Serializes load operations.

Description

Performs a serializing operation on all load-from-memory instructions that were issued prior the LFENCE instruction. This serializing operation guarantees that every load instruction that precedes in program order the LFENCE instruction is globally visible before any load instruction that follows the LFENCE instruction is globally visible. The LFENCE instruction is ordered with respect to load instructions, other LFENCE instructions, any MFENCE instructions, and any serializing instructions (such as the CPUID instruction). It is not ordered with respect to store instructions or the SFENCE instruction.

Weakly ordered memory types can be used to achieve higher processor performance through such techniques as out-of-order issue and speculative reads. The degree to which a consumer of data recognizes or knows that the data is weakly ordered varies among applications and may be unknown to the producer of this data. The LFENCE instruction provides a performance-efficient way of insuring load ordering between routines that produce weakly-ordered results and routines that consume that data.

It should be noted that processors are free to speculatively fetch and cache data from system memory regions that are assigned a memory-type that permits speculative reads (that is, the WB, WC, and WT memory types). The PREFETCH h instruction is considered a hint to this speculative behavior. Because this speculative fetching can occur at any time and is not tied to instruction execution, the LFENCE instruction is not ordered with respect to PREFETCH h instructions or any other speculative fetching mechanism (that is, data could be speculative loaded into the cache just before, during, or after the execution of an LFENCE instruction).

This instruction's operation is the same in non-64-bit modes and 64-bit mode.

Operation

Wait_On_Following_Loads_Until(preceding_loads_globally_visible);

Intel C/C++ Compiler Intrinsic Equivalent

void _mm_lfence(void)

Exceptions (All Modes of Operation)

#UD If the LOCK prefix is used.

LGDT/LIDT—Load Global/Interrupt Descriptor Table Register

Opcode	Instruction	64-Bit Mode	Compat/ Leg Mode	Description
OF 01 /2	LGDT <i>m16&32</i>	N.E.	Valid	Load <i>m</i> into GDTR.
OF 01 /3	LIDT <i>m16&32</i>	N.E.	Valid	Load <i>m</i> into IDTR.
OF 01 /2	LGDT <i>m16&64</i>	Valid	N.E.	Load <i>m</i> into GDTR.
OF 01 /3	LIDT <i>m16&64</i>	Valid	N.E.	Load <i>m</i> into IDTR.

Description

Loads the values in the source operand into the global descriptor table register (GDTR) or the interrupt descriptor table register (IDTR). The source operand specifies a 6-byte memory location that contains the base address (a linear address) and the limit (size of table in bytes) of the global descriptor table (GDT) or the interrupt descriptor table (IDT). If operand-size attribute is 32 bits, a 16-bit limit (lower 2 bytes of the 6-byte data operand) and a 32-bit base address (upper 4 bytes of the data operand) are loaded into the register. If the operand-size attribute is 16 bits, a 16-bit limit (lower 2 bytes) and a 24-bit base address (third, fourth, and fifth byte) are loaded. Here, the high-order byte of the operand is not used and the high-order byte of the base address in the GDTR or IDTR is filled with zeros.

The LGDT and LIDT instructions are used only in operating-system software; they are not used in application programs. They are the only instructions that directly load a linear address (that is, not a segment-relative address) and a limit in protected mode. They are commonly executed in real-address mode to allow processor initialization prior to switching to protected mode.

In 64-bit mode, the instruction's operand size is fixed at 8+2 bytes (an 8-byte base and a 2-byte limit). See the summary chart at the beginning of this section for encoding data and limits.

See “SGDT—Store Global Descriptor Table Register” in Chapter 4, *Intel® 64 and IA-32 Architectures Software Developer's Manual, Volume 2B*, for information on storing the contents of the GDTR and IDTR.

Operation

```
IF Instruction is LIDT
  THEN
    IF OperandSize = 16
      THEN
        IDTR(Limit) ← SRC[0:15];
        IDTR(Base) ← SRC[16:47] AND 00FFFFFFFH;
      ELSE IF 32-bit Operand Size
        THEN
```

```

        IDTR(Limit) ← SRC[0:15];
        IDTR(Base) ← SRC[16:47];
    FI;
ELSE IF 64-bit Operand Size (* In 64-Bit Mode *)
    THEN
        IDTR(Limit) ← SRC[0:15];
        IDTR(Base) ← SRC[16:79];
    FI;
FI;
ELSE (* Instruction is LGDT *)
    IF OperandSize = 16
        THEN
            GDTR(Limit) ← SRC[0:15];
            GDTR(Base) ← SRC[16:47] AND 00FFFFFFH;
        ELSE IF 32-bit Operand Size
            THEN
                GDTR(Limit) ← SRC[0:15];
                GDTR(Base) ← SRC[16:47];
            FI;
        ELSE IF 64-bit Operand Size (* In 64-Bit Mode *)
            THEN
                GDTR(Limit) ← SRC[0:15];
                GDTR(Base) ← SRC[16:79];
            FI;
        FI;
FI;

```

Flags Affected

None.

Protected Mode Exceptions

#UD	If source operand is not a memory location. If the LOCK prefix is used.
#GP(0)	If the current privilege level is not 0. If a memory operand effective address is outside the CS, DS, ES, FS, or GS segment limit. If the DS, ES, FS, or GS register is used to access memory and it contains a NULL segment selector.
#SS(0)	If a memory operand effective address is outside the SS segment limit.
#PF(fault-code)	If a page fault occurs.

Real-Address Mode Exceptions

#UD	If source operand is not a memory location. If the LOCK prefix is used.
#GP	If a memory operand effective address is outside the CS, DS, ES, FS, or GS segment limit.
#SS	If a memory operand effective address is outside the SS segment limit.

Virtual-8086 Mode Exceptions

#UD	If source operand is not a memory location. If the LOCK prefix is used.
#GP(0)	The LGDT and LIDT instructions are not recognized in virtual-8086 mode.
#GP	If the current privilege level is not 0.

Compatibility Mode Exceptions

Same exceptions as in protected mode.

64-Bit Mode Exceptions

#SS(0)	If a memory address referencing the SS segment is in a non-canonical form.
#GP(0)	If the current privilege level is not 0. If the memory address is in a non-canonical form.
#UD	If source operand is not a memory location. If the LOCK prefix is used.
#PF(fault-code)	If a page fault occurs.

LLDT—Load Local Descriptor Table Register

Opcode	Instruction	64-Bit Mode	Compat/Leg Mode	Description
OF 00 /2	LLDT <i>r/m16</i>	Valid	Valid	Load segment selector <i>r/m16</i> into LDTR.

Description

Loads the source operand into the segment selector field of the local descriptor table register (LDTR). The source operand (a general-purpose register or a memory location) contains a segment selector that points to a local descriptor table (LDT). After the segment selector is loaded in the LDTR, the processor uses the segment selector to locate the segment descriptor for the LDT in the global descriptor table (GDT). It then loads the segment limit and base address for the LDT from the segment descriptor into the LDTR. The segment registers DS, ES, SS, FS, GS, and CS are not affected by this instruction, nor is the LDTR field in the task state segment (TSS) for the current task.

If bits 2-15 of the source operand are 0, LDTR is marked invalid and the LLDT instruction completes silently. However, all subsequent references to descriptors in the LDT (except by the LAR, VERR, VERW or LSL instructions) cause a general protection exception (#GP).

The operand-size attribute has no effect on this instruction.

The LLDT instruction is provided for use in operating-system software; it should not be used in application programs. This instruction can only be executed in protected mode or 64-bit mode.

In 64-bit mode, the operand size is fixed at 16 bits.

Operation

```
IF SRC(Offset) > descriptor table limit
  THEN #GP(segment selector); FI;
```

```
IF segment selector is valid
```

```
  Read segment descriptor;
```

```
  IF SegmentDescriptor(Type) ≠ LDT
    THEN #GP(segment selector); FI;
```

```
  IF segment descriptor is not present
    THEN #NP(segment selector); FI;
```

```
  LDTR(SegmentSelector) ← SRC;
```

```
  LDTR(SegmentDescriptor) ← GDTSegmentDescriptor;
```

ELSE LDTR ← INVALID
FI;

Flags Affected

None.

Protected Mode Exceptions

#GP(0)	If the current privilege level is not 0. If a memory operand effective address is outside the CS, DS, ES, FS, or GS segment limit. If the DS, ES, FS, or GS register contains a NULL segment selector.
#GP(selector)	If the selector operand does not point into the Global Descriptor Table or if the entry in the GDT is not a Local Descriptor Table. Segment selector is beyond GDT limit.
#SS(0)	If a memory operand effective address is outside the SS segment limit.
#NP(selector)	If the LDT descriptor is not present.
#PF(fault-code)	If a page fault occurs.
#UD	If the LOCK prefix is used.

Real-Address Mode Exceptions

#UD	The LLDT instruction is not recognized in real-address mode.
-----	--------------------------------------------------------------

Virtual-8086 Mode Exceptions

#UD	The LLDT instruction is not recognized in virtual-8086 mode.
-----	--------------------------------------------------------------

Compatibility Mode Exceptions

Same exceptions as in protected mode.

64-Bit Mode Exceptions

#SS(0)	If a memory address referencing the SS segment is in a non-canonical form.
#GP(0)	If the current privilege level is not 0. If the memory address is in a non-canonical form.
#GP(selector)	If the selector operand does not point into the Global Descriptor Table or if the entry in the GDT is not a Local Descriptor Table. Segment selector is beyond GDT limit.
#NP(selector)	If the LDT descriptor is not present.

#PF(fault-code) If a page fault occurs.
#UD If the LOCK prefix is used.

LMSW—Load Machine Status Word

Opcode	Instruction	64-Bit Mode	Compat/ Leg Mode	Description
0F 01 /6	LMSW <i>r/m</i> 16	Valid	Valid	Loads <i>r/m</i> 16 in machine status word of CR0.

Description

Loads the source operand into the machine status word, bits 0 through 15 of register CR0. The source operand can be a 16-bit general-purpose register or a memory location. Only the low-order 4 bits of the source operand (which contains the PE, MP, EM, and TS flags) are loaded into CR0. The PG, CD, NW, AM, WP, NE, and ET flags of CR0 are not affected. The operand-size attribute has no effect on this instruction.

If the PE flag of the source operand (bit 0) is set to 1, the instruction causes the processor to switch to protected mode. While in protected mode, the LMSW instruction cannot be used to clear the PE flag and force a switch back to real-address mode.

The LMSW instruction is provided for use in operating-system software; it should not be used in application programs. In protected or virtual-8086 mode, it can only be executed at CPL 0.

This instruction is provided for compatibility with the Intel 286 processor; programs and procedures intended to run on the Pentium 4, Intel Xeon, P6 family, Pentium, Intel486, and Intel386 processors should use the MOV (control registers) instruction to load the whole CR0 register. The MOV CR0 instruction can be used to set and clear the PE flag in CR0, allowing a procedure or program to switch between protected and real-address modes.

This instruction is a serializing instruction.

This instruction's operation is the same in non-64-bit modes and 64-bit mode. Note that the operand size is fixed at 16 bits.

See “Changes to Instruction Behavior in VMX Non-Root Operation” in Chapter 22 of the *Intel® 64 and IA-32 Architectures Software Developer's Manual, Volume 3B*, for more information about the behavior of this instruction in VMX non-root operation.

Operation

CR0[0:3] ← SRC[0:3];

Flags Affected

None.

Protected Mode Exceptions

#GP(0)	If the current privilege level is not 0. If a memory operand effective address is outside the CS, DS, ES, FS, or GS segment limit. If the DS, ES, FS, or GS register is used to access memory and it contains a NULL segment selector.
#SS(0)	If a memory operand effective address is outside the SS segment limit.
#PF(fault-code)	If a page fault occurs.
#UD	If the LOCK prefix is used.

Real-Address Mode Exceptions

#GP	If a memory operand effective address is outside the CS, DS, ES, FS, or GS segment limit.
#UD	If the LOCK prefix is used.

Virtual-8086 Mode Exceptions

#GP(0)	If a memory operand effective address is outside the CS, DS, ES, FS, or GS segment limit.
#SS(0)	If a memory operand effective address is outside the SS segment limit.
#PF(fault-code)	If a page fault occurs.
#UD	If the LOCK prefix is used.

Compatibility Mode Exceptions

Same exceptions as in protected mode.

64-Bit Mode Exceptions

#SS(0)	If a memory address referencing the SS segment is in a non-canonical form.
#GP(0)	If the current privilege level is not 0. If the memory address is in a non-canonical form.
#PF(fault-code)	If a page fault occurs.
#UD	If the LOCK prefix is used.

LOCK—Assert LOCK# Signal Prefix

Opcode*	Instruction	64-Bit Mode	Compat/ Leg Mode	Description
F0	LOCK	Valid	Valid	Asserts LOCK# signal for duration of the accompanying instruction.

NOTES:

* See IA-32 Architecture Compatibility section below.

Description

Causes the processor's LOCK# signal to be asserted during execution of the accompanying instruction (turns the instruction into an atomic instruction). In a multiprocessor environment, the LOCK# signal insures that the processor has exclusive use of any shared memory while the signal is asserted.

Note that, in later Intel 64 and IA-32 processors (including the Pentium 4, Intel Xeon, and P6 family processors), locking may occur without the LOCK# signal being asserted. See the "IA-32 Architecture Compatibility" section below.

The LOCK prefix can be prepended only to the following instructions and only to those forms of the instructions where the destination operand is a memory operand: ADD, ADC, AND, BTC, BTR, BTS, CMPXCHG, CMPXCH8B, DEC, INC, NEG, NOT, OR, SBB, SUB, XOR, XADD, and XCHG. If the LOCK prefix is used with one of these instructions and the source operand is a memory operand, an undefined opcode exception (#UD) may be generated. An undefined opcode exception will also be generated if the LOCK prefix is used with any instruction not in the above list. The XCHG instruction always asserts the LOCK# signal regardless of the presence or absence of the LOCK prefix.

The LOCK prefix is typically used with the BTS instruction to perform a read-modify-write operation on a memory location in shared memory environment.

The integrity of the LOCK prefix is not affected by the alignment of the memory field. Memory locking is observed for arbitrarily misaligned fields.

This instruction's operation is the same in non-64-bit modes and 64-bit mode.

IA-32 Architecture Compatibility

Beginning with the P6 family processors, when the LOCK prefix is prefixed to an instruction and the memory area being accessed is cached internally in the processor, the LOCK# signal is generally not asserted. Instead, only the processor's cache is locked. Here, the processor's cache coherency mechanism insures that the operation is carried out atomically with regards to memory. See "Effects of a Locked Operation on Internal Processor Caches" in Chapter 8 of *Intel® 64 and IA-32 Architectures Software Developer's Manual, Volume 3A*, for more information on locking of caches.

Operation

Assert LOCK#(DurationOfAccompanyingInstruction);

Flags Affected

None.

Protected Mode Exceptions

#UD If the LOCK prefix is used with an instruction not listed: ADD, ADC, AND, BTC, BTR, BTS, CMPXCHG, CMPXCH8B, DEC, INC, NEG, NOT, OR, SBB, SUB, XOR, XADD, XCHG.
Other exceptions can be generated by the instruction when the LOCK prefix is applied.

Real-Address Mode Exceptions

Same exceptions as in protected mode.

Virtual-8086 Mode Exceptions

Same exceptions as in protected mode.

Compatibility Mode Exceptions

Same exceptions as in protected mode.

64-Bit Mode Exceptions

Same exceptions as in protected mode.

LODS/LODSB/LODSW/LODSD/LODSQ—Load String

Opcode	Instruction	64-Bit Mode	Compat/ Leg Mode	Description
AC	LODS <i>m8</i>	Valid	Valid	For legacy mode, Load byte at address DS:(E)SI into AL. For 64-bit mode load byte at address (R)SI into AL.
AD	LODS <i>m16</i>	Valid	Valid	For legacy mode, Load word at address DS:(E)SI into AX. For 64-bit mode load word at address (R)SI into AX.
AD	LODS <i>m32</i>	Valid	Valid	For legacy mode, Load dword at address DS:(E)SI into EAX. For 64-bit mode load dword at address (R)SI into EAX.
REX.W + AD	LODS <i>m64</i>	Valid	N.E.	Load qword at address (R)SI into RAX.
AC	LODSB	Valid	Valid	For legacy mode, Load byte at address DS:(E)SI into AL. For 64-bit mode load byte at address (R)SI into AL.
AD	LODSW	Valid	Valid	For legacy mode, Load word at address DS:(E)SI into AX. For 64-bit mode load word at address (R)SI into AX.
AD	LODSD	Valid	Valid	For legacy mode, Load dword at address DS:(E)SI into EAX. For 64-bit mode load dword at address (R)SI into EAX.
REX.W + AD	LODSQ	Valid	N.E.	Load qword at address (R)SI into RAX.

Description

Loads a byte, word, or doubleword from the source operand into the AL, AX, or EAX register, respectively. The source operand is a memory location, the address of which is read from the DS:EDI or the DS:SI registers (depending on the address-size attribute of the instruction, 32 or 16, respectively). The DS segment may be overridden with a segment override prefix.

At the assembly-code level, two forms of this instruction are allowed: the “explicit-operands” form and the “no-operands” form. The explicit-operands form (specified with the LODS mnemonic) allows the source operand to be specified explicitly. Here, the source operand should be a symbol that indicates the size and location of the source value. The destination operand is then automatically selected to match the size of the source operand (the AL register for byte operands, AX for word operands, and EAX for doubleword operands). This explicit-operands form is provided to allow documentation; however, note that the documentation provided by this form can be misleading. That is, the source operand symbol must specify the correct **type** (size) of the operand (byte, word, or doubleword), but it does not have to specify the

correct **location**. The location is always specified by the DS:(E)SI registers, which must be loaded correctly before the load string instruction is executed.

The no-operands form provides “short forms” of the byte, word, and doubleword versions of the LODS instructions. Here also DS:(E)SI is assumed to be the source operand and the AL, AX, or EAX register is assumed to be the destination operand. The size of the source and destination operands is selected with the mnemonic: LODSB (byte loaded into register AL), LODSW (word loaded into AX), or LODSD (doubleword loaded into EAX).

After the byte, word, or doubleword is transferred from the memory location into the AL, AX, or EAX register, the (E)SI register is incremented or decremented automatically according to the setting of the DF flag in the EFLAGS register. (If the DF flag is 0, the (E)SI register is incremented; if the DF flag is 1, the ESI register is decremented.) The (E)SI register is incremented or decremented by 1 for byte operations, by 2 for word operations, or by 4 for doubleword operations.

In 64-bit mode, use of the REX.W prefix promotes operation to 64 bits. LODS/LODSQ load the quadword at address (R)SI into RAX. The (R)SI register is then incremented or decremented automatically according to the setting of the DF flag in the EFLAGS register.

The LODS, LODSB, LODSW, and LODSD instructions can be preceded by the REP prefix for block loads of ECX bytes, words, or doublewords. More often, however, these instructions are used within a LOOP construct because further processing of the data moved into the register is usually necessary before the next transfer can be made. See “RDTSCP—Read Time-Stamp Counter and Processor ID” in Chapter 4, *Intel® 64 and IA-32 Architectures Software Developer’s Manual, Volume 2B*, for a description of the REP prefix.

Operation

```

IF AL ← SRC; (* Byte load *)
  THEN AL ← SRC; (* Byte load *)
    IF DF = 0
      THEN (E)SI ← (E)SI + 1;
      ELSE (E)SI ← (E)SI - 1;
    FI;
ELSE IF AX ← SRC; (* Word load *)
  THEN IF DF = 0
    THEN (E)SI ← (E)SI + 2;
    ELSE (E)SI ← (E)SI - 2;
  IF;
FI;
ELSE IF EAX ← SRC; (* Doubleword load *)
  THEN IF DF = 0
    THEN (E)SI ← (E)SI + 4;
    ELSE (E)SI ← (E)SI - 4;

```

```

    FI;
  FI;
ELSE IF RAX ← SRC; (* Quadword load *)
  THEN IF DF = 0
    THEN (R)SI ← (R)SI + 8;
    ELSE (R)SI ← (R)SI - 8;
  FI;
FI;
FI;

```

Flags Affected

None.

Protected Mode Exceptions

#GP(0)	If a memory operand effective address is outside the CS, DS, ES, FS, or GS segment limit. If the DS, ES, FS, or GS register contains a NULL segment selector.
#SS(0)	If a memory operand effective address is outside the SS segment limit.
#PF(fault-code)	If a page fault occurs.
#AC(0)	If alignment checking is enabled and an unaligned memory reference is made while the current privilege level is 3.
#UD	If the LOCK prefix is used.

Real-Address Mode Exceptions

#GP	If a memory operand effective address is outside the CS, DS, ES, FS, or GS segment limit.
#SS	If a memory operand effective address is outside the SS segment limit.
#UD	If the LOCK prefix is used.

Virtual-8086 Mode Exceptions

#GP(0)	If a memory operand effective address is outside the CS, DS, ES, FS, or GS segment limit.
#SS(0)	If a memory operand effective address is outside the SS segment limit.
#PF(fault-code)	If a page fault occurs.
#AC(0)	If alignment checking is enabled and an unaligned memory reference is made.
#UD	If the LOCK prefix is used.

Compatibility Mode Exceptions

Same exceptions as in protected mode.

64-Bit Mode Exceptions

#SS(0)	If a memory address referencing the SS segment is in a non-canonical form.
#GP(0)	If the memory address is in a non-canonical form.
#PF(fault-code)	If a page fault occurs.
#AC(0)	If alignment checking is enabled and an unaligned memory reference is made while the current privilege level is 3.
#UD	If the LOCK prefix is used.

LOOP/LOOP_{cc}—Loop According to ECX Counter

Opcode	Instruction	64-Bit Mode	Compat/ Leg Mode	Description
E2 <i>cb</i>	LOOP <i>rel8</i>	Valid	Valid	Decrement count; jump short if count ≠ 0.
E1 <i>cb</i>	LOOPE <i>rel8</i>	Valid	Valid	Decrement count; jump short if count ≠ 0 and ZF = 1.
E0 <i>cb</i>	LOOPNE <i>rel8</i>	Valid	Valid	Decrement count; jump short if count ≠ 0 and ZF = 0.

Description

Performs a loop operation using the RCX, ECX or CX register as a counter (depending on whether address size is 64 bits, 32 bits, or 16 bits). Note that the LOOP instruction ignores REX.W; but 64-bit address size can be over-ridden using a 67H prefix.

Each time the LOOP instruction is executed, the count register is decremented, then checked for 0. If the count is 0, the loop is terminated and program execution continues with the instruction following the LOOP instruction. If the count is not zero, a near jump is performed to the destination (target) operand, which is presumably the instruction at the beginning of the loop.

The target instruction is specified with a relative offset (a signed offset relative to the current value of the instruction pointer in the IP/EIP/RIP register). This offset is generally specified as a label in assembly code, but at the machine code level, it is encoded as a signed, 8-bit immediate value, which is added to the instruction pointer. Offsets of −128 to +127 are allowed with this instruction.

Some forms of the loop instruction (LOOP_{cc}) also accept the ZF flag as a condition for terminating the loop before the count reaches zero. With these forms of the instruction, a condition code (*cc*) is associated with each instruction to indicate the condition being tested for. Here, the LOOP_{cc} instruction itself does not affect the state of the ZF flag; the ZF flag is changed by other instructions in the loop.

Operation

```
IF (AddressSize = 32)
    THEN Count is ECX;
ELSE IF (AddressSize = 64)
    Count is RCX;
ELSE Count is CX;
FI;
```

```
Count ← Count - 1;
```

```
IF Instruction is not LOOP
    THEN
```

```

IF (Instruction ← LOOPE) or (Instruction ← LOOPZ)
  THEN IF (ZF = 1) and (Count ≠ 0)
    THEN BranchCond ← 1;
    ELSE BranchCond ← 0;
  FI;
ELSE (Instruction = LOOPNE) or (Instruction = LOOPNZ)
  IF (ZF = 0) and (Count ≠ 0)
    THEN BranchCond ← 1;
    ELSE BranchCond ← 0;
  FI;
FI;
ELSE (* Instruction = LOOP *)
  IF (Count ≠ 0)
    THEN BranchCond ← 1;
    ELSE BranchCond ← 0;
  FI;
FI;

IF BranchCond = 1
  THEN
    IF OperandSize = 32
      THEN EIP ← EIP + SignExtend(DEST);
      ELSE IF OperandSize = 64
        THEN RIP ← RIP + SignExtend(DEST);
        FI;
      ELSE IF OperandSize = 16
        THEN EIP ← EIP AND 0000FFFFH;
        FI;
      ELSE IF OperandSize = (32 or 64)
        THEN IF (R/E)IP < CS.Base or (R/E)IP > CS.Limit
          #GP; FI;
        FI;
      FI;
    ELSE
      Terminate loop and continue program execution at (R/E)IP;
    FI;

```

Flags Affected

None.

Protected Mode Exceptions

- #GP(0) If the offset being jumped to is beyond the limits of the CS segment.
- #UD If the LOCK prefix is used.

Real-Address Mode Exceptions

- #GP If the offset being jumped to is beyond the limits of the CS segment or is outside of the effective address space from 0 to FFFFH. This condition can occur if a 32-bit address size override prefix is used.
- #UD If the LOCK prefix is used.

Virtual-8086 Mode Exceptions

Same exceptions as in real address mode.

Compatibility Mode Exceptions

Same exceptions as in protected mode.

64-Bit Mode Exceptions

- #GP(0) If the offset being jumped to is in a non-canonical form.
- #UD If the LOCK prefix is used.

LSL—Load Segment Limit

Opcode	Instruction	64-Bit Mode	Compat/ Leg Mode	Description
OF 03 /r	LSL <i>r16, r16/m16</i>	Valid	Valid	Load: <i>r16</i> ← segment limit, selector <i>r16/m16</i> .
OF 03 /r	LSL <i>r32, r32/m16</i> *	Valid	Valid	Load: <i>r32</i> ← segment limit, selector <i>r32/m16</i> .
REX.W + OF 03 /r	LSL <i>r64, r32/m16</i> *	Valid	Valid	Load: <i>r64</i> ← segment limit, selector <i>r32/m16</i>

NOTES:

* For all loads (regardless of destination sizing), only bits 16-0 are used. Other bits are ignored.

Description

Loads the unscrambled segment limit from the segment descriptor specified with the second operand (source operand) into the first operand (destination operand) and sets the ZF flag in the EFLAGS register. The source operand (which can be a register or a memory location) contains the segment selector for the segment descriptor being accessed. The destination operand is a general-purpose register.

The processor performs access checks as part of the loading process. Once loaded in the destination register, software can compare the segment limit with the offset of a pointer.

The segment limit is a 20-bit value contained in bytes 0 and 1 and in the first 4 bits of byte 6 of the segment descriptor. If the descriptor has a byte granular segment limit (the granularity flag is set to 0), the destination operand is loaded with a byte granular value (byte limit). If the descriptor has a page granular segment limit (the granularity flag is set to 1), the LSL instruction will translate the page granular limit (page limit) into a byte limit before loading it into the destination operand. The translation is performed by shifting the 20-bit “raw” limit left 12 bits and filling the low-order 12 bits with 1s.

When the operand size is 32 bits, the 32-bit byte limit is stored in the destination operand. When the operand size is 16 bits, a valid 32-bit limit is computed; however, the upper 16 bits are truncated and only the low-order 16 bits are loaded into the destination operand.

This instruction performs the following checks before it loads the segment limit into the destination register:

- Checks that the segment selector is not NULL.
- Checks that the segment selector points to a descriptor that is within the limits of the GDT or LDT being accessed

- Checks that the descriptor type is valid for this instruction. All code and data segment descriptors are valid for (can be accessed with) the LSL instruction. The valid special segment and gate descriptor types are given in the following table.
- If the segment is not a conforming code segment, the instruction checks that the specified segment descriptor is visible at the CPL (that is, if the CPL and the RPL of the segment selector are less than or equal to the DPL of the segment selector).

If the segment descriptor cannot be accessed or is an invalid type for the instruction, the ZF flag is cleared and no value is loaded in the destination operand.

Table 3-68. Segment and Gate Descriptor Types

Type	Protected Mode		IA-32e Mode	
	Name	Valid	Name	Valid
0	Reserved	No	Upper 8 byte of a 16-Byte descriptor	Yes
1	Available 16-bit TSS	Yes	Reserved	No
2	LDT	Yes	LDT	Yes
3	Busy 16-bit TSS	Yes	Reserved	No
4	16-bit call gate	No	Reserved	No
5	16-bit/32-bit task gate	No	Reserved	No
6	16-bit interrupt gate	No	Reserved	No
7	16-bit trap gate	No	Reserved	No
8	Reserved	No	Reserved	No
9	Available 32-bit TSS	Yes	64-bit TSS	Yes
A	Reserved	No	Reserved	No
B	Busy 32-bit TSS	Yes	Busy 64-bit TSS	Yes
C	32-bit call gate	No	64-bit call gate	No
D	Reserved	No	Reserved	No
E	32-bit interrupt gate	No	64-bit interrupt gate	No
F	32-bit trap gate	No	64-bit trap gate	No

Operation

IF SRC(Offset) > descriptor table limit
THEN ZF ← 0; FI;

Read segment descriptor;

IF SegmentDescriptor(Type) ≠ conforming code segment
and (CPL > DPL) OR (RPL > DPL)
or Segment type is not valid for instruction

THEN

ZF ← 0;

ELSE

temp ← SegmentLimit([SRC]);

IF (G ← 1)

THEN temp ← ShiftLeft(12, temp) OR 00000FFFH;

ELSE IF OperandSize = 32

THEN DEST ← temp; FI;

ELSE IF OperandSize = 64 (* REX.W used *)

THEN DEST (* Zero-extended *) ← temp; FI;

ELSE (* OperandSize = 16 *)

DEST ← temp AND FFFFH;

FI;

FI;

Flags Affected

The ZF flag is set to 1 if the segment limit is loaded successfully; otherwise, it is set to 0.

Protected Mode Exceptions

#GP(0)	If a memory operand effective address is outside the CS, DS, ES, FS, or GS segment limit. If the DS, ES, FS, or GS register is used to access memory and it contains a NULL segment selector.
#SS(0)	If a memory operand effective address is outside the SS segment limit.
#PF(fault-code)	If a page fault occurs.
#AC(0)	If alignment checking is enabled and the memory operand effective address is unaligned while the current privilege level is 3.
#UD	If the LOCK prefix is used.

Real-Address Mode Exceptions

#UD	The LAR instruction cannot be executed in real-address mode.
-----	--------------------------------------------------------------

Virtual-8086 Mode Exceptions

#UD	The LAR instruction cannot be executed in virtual-8086 mode.
-----	--------------------------------------------------------------

Compatibility Mode Exceptions

Same exceptions as in protected mode.

64-Bit Mode Exceptions

#SS(0)	If the memory operand effective address referencing the SS segment is in a non-canonical form.
#GP(0)	If the memory operand effective address is in a non-canonical form.
#PF(fault-code)	If a page fault occurs.
#AC(0)	If alignment checking is enabled and the memory operand effective address is unaligned while the current privilege level is 3.
#UD	If the LOCK prefix is used.

LTR—Load Task Register

Opcode	Instruction	64-Bit Mode	Compat/Leg Mode	Description
0F 00 /3	LTR <i>r/m16</i>	Valid	Valid	Load <i>r/m16</i> into task register.

Description

Loads the source operand into the segment selector field of the task register. The source operand (a general-purpose register or a memory location) contains a segment selector that points to a task state segment (TSS). After the segment selector is loaded in the task register, the processor uses the segment selector to locate the segment descriptor for the TSS in the global descriptor table (GDT). It then loads the segment limit and base address for the TSS from the segment descriptor into the task register. The task pointed to by the task register is marked busy, but a switch to the task does not occur.

The LTR instruction is provided for use in operating-system software; it should not be used in application programs. It can only be executed in protected mode when the CPL is 0. It is commonly used in initialization code to establish the first task to be executed.

The operand-size attribute has no effect on this instruction.

In 64-bit mode, the operand size is still fixed at 16 bits. The instruction references a 16-byte descriptor to load the 64-bit base.

Operation

IF SRC is a NULL selector
THEN #GP(0);

IF SRC(Offset) > descriptor table limit OR IF SRC(type) ≠ global
THEN #GP(segment selector); FI;

Read segment descriptor;

IF segment descriptor is not for an available TSS
THEN #GP(segment selector); FI;

IF segment descriptor is not present
THEN #NP(segment selector); FI;

TSSsegmentDescriptor(busy) ← 1;

(* Locked read-modify-write operation on the entire descriptor when setting busy flag *)

TaskRegister(SegmentSelector) ← SRC;

TaskRegister(SegmentDescriptor) ← TSSSegmentDescriptor;

Flags Affected

None.

Protected Mode Exceptions

#GP(0)	<p>If the current privilege level is not 0.</p> <p>If a memory operand effective address is outside the CS, DS, ES, FS, or GS segment limit.</p> <p>If the source operand contains a NULL segment selector.</p> <p>If the DS, ES, FS, or GS register is used to access memory and it contains a NULL segment selector.</p>
#GP(selector)	<p>If the source selector points to a segment that is not a TSS or to one for a task that is already busy.</p> <p>If the selector points to LDT or is beyond the GDT limit.</p>
#NP(selector)	If the TSS is marked not present.
#SS(0)	If a memory operand effective address is outside the SS segment limit.
#PF(fault-code)	If a page fault occurs.
#UD	If the LOCK prefix is used.

Real-Address Mode Exceptions

#UD	The LTR instruction is not recognized in real-address mode.
-----	-------------------------------------------------------------

Virtual-8086 Mode Exceptions

#UD	The LTR instruction is not recognized in virtual-8086 mode.
-----	-------------------------------------------------------------

Compatibility Mode Exceptions

Same exceptions as in protected mode.

64-Bit Mode Exceptions

#SS(0)	If a memory address referencing the SS segment is in a non-canonical form.
#GP(0)	<p>If the current privilege level is not 0.</p> <p>If the memory address is in a non-canonical form.</p> <p>If the source operand contains a NULL segment selector.</p>
#GP(selector)	<p>If the source selector points to a segment that is not a TSS or to one for a task that is already busy.</p> <p>If the selector points to LDT or is beyond the GDT limit.</p> <p>If the descriptor type of the upper 8-byte of the 16-byte descriptor is non-zero.</p>

#NP(selector)	If the TSS is marked not present.
#PF(fault-code)	If a page fault occurs.
#UD	If the LOCK prefix is used.

MASKMOVDQU—Store Selected Bytes of Double Quadword

Opcode	Instruction	64-Bit Mode	Compat/Leg Mode	Description
66 0F F7 /r	MASKMOVDQU <i>xmm1, xmm2</i>	Valid	Valid	Selectively write bytes from <i>xmm1</i> to memory location using the byte mask in <i>xmm2</i> . The default memory location is specified by DS:EDI.

Description

Stores selected bytes from the source operand (first operand) into an 128-bit memory location. The mask operand (second operand) selects which bytes from the source operand are written to memory. The source and mask operands are XMM registers. The location of the first byte of the memory location is specified by DI/EDI and DS registers. The memory location does not need to be aligned on a natural boundary. (The size of the store address depends on the address-size attribute.)

The most significant bit in each byte of the mask operand determines whether the corresponding byte in the source operand is written to the corresponding byte location in memory: 0 indicates no write and 1 indicates write.

The MASKMOVDQU instruction generates a non-temporal hint to the processor to minimize cache pollution. The non-temporal hint is implemented by using a write combining (WC) memory type protocol (see “Caching of Temporal vs. Non-Temporal Data” in Chapter 10, of the *Intel® 64 and IA-32 Architectures Software Developer’s Manual, Volume 1*). Because the WC protocol uses a weakly-ordered memory consistency model, a fencing operation implemented with the SFENCE or MFENCE instruction should be used in conjunction with MASKMOVEDQU instructions if multiple processors might use different memory types to read/write the destination memory locations.

Behavior with a mask of all 0s is as follows:

- No data will be written to memory.
- Signaling of breakpoints (code or data) is not guaranteed; different processor implementations may signal or not signal these breakpoints.
- Exceptions associated with addressing memory and page faults may still be signaled (implementation dependent).
- If the destination memory region is mapped as UC or WP, enforcement of associated semantics for these memory types is not guaranteed (that is, is reserved) and is implementation-specific.

The MASKMOVDQU instruction can be used to improve performance of algorithms that need to merge data on a byte-by-byte basis. MASKMOVDQU should not cause a read for ownership; doing so generates unnecessary bandwidth since data is to be written directly using the byte-mask without allocating old data prior to the store.

In 64-bit mode, use of the REX.R prefix permits this instruction to access additional registers (XMM8-XMM15).

Operation

```
IF (MASK[7] = 1)
    THEN DEST[DI/EDI] ← SRC[7:0] ELSE (* Memory location unchanged *); FI;
IF (MASK[15] = 1)
    THEN DEST[DI/EDI + 1] ← SRC[15:8] ELSE (* Memory location unchanged *); FI;
    (* Repeat operation for 3rd through 14th bytes in source operand *)
IF (MASK[127] = 1)
    THEN DEST[DI/EDI + 15] ← SRC[127:120] ELSE (* Memory location unchanged *); FI;
```

Intel C/C++ Compiler Intrinsic Equivalent

```
void _mm_maskmoveu_si128(__m128i d, __m128i n, char * p)
```

Protected Mode Exceptions

#GP(0)	For an illegal memory operand effective address in the CS, DS, ES, FS or GS segments. (even if mask is all 0s). If the destination operand is in a nonwritable segment. If the DS, ES, FS, or GS register contains a NULL segment selector.
#SS(0)	For an illegal address in the SS segment (even if mask is all 0s).
#PF(fault-code)	For a page fault (implementation specific).
#NM	If CR0.TS[bit 3] = 1.
#UD	If CR0.EM[bit 2] = 1. If CR4.OSFXSR[bit 9] = 0. If CPUID.01H:EDX.SSE2[bit 26] = 0. If the LOCK prefix is used.

Real-Address Mode Exceptions

GP	If any part of the operand lies outside the effective address space from 0 to FFFFH. (even if mask is all 0s).
#NM	If CR0.TS[bit 3] = 1.
#UD	If CR0.EM[bit 2] = 1. If CR4.OSFXSR[bit 9] = 0. If CPUID.01H:EDX.SSE2[bit 26] = 0. If the LOCK prefix is used.

Virtual-8086 Mode Exceptions

Same exceptions as in real address mode.

- #PF(fault-code) For a page fault (implementation specific).
- #UD If the LOCK prefix is used.

Compatibility Mode Exceptions

Same exceptions as in protected mode.

64-Bit Mode Exceptions

- #GP(0) If the memory address is in a non-canonical form.
- #SS(0) If a memory address referencing the SS segment is in a non-canonical form.
- #PF(fault-code) For a page fault (implementation specific).
- #NM If CR0.TS[bit 3] = 1.
- #UD If CR0.EM[bit 2] = 1.
If CR4.OSFXSR[bit 9] = 0.
If CPUID.01H:EDX.SSE2[bit 26] = 0.
If the LOCK prefix is used.

MASKMOVQ—Store Selected Bytes of Quadword

Opcode	Instruction	64-Bit Mode	Compat/Leg Mode	Description
OF F7 /r	MASKMOVQ <i>mm1</i> , <i>mm2</i>	Valid	Valid	Selectively write bytes from <i>mm1</i> to memory location using the byte mask in <i>mm2</i> . The default memory location is specified by DS:EDI.

Description

Stores selected bytes from the source operand (first operand) into a 64-bit memory location. The mask operand (second operand) selects which bytes from the source operand are written to memory. The source and mask operands are MMX technology registers. The location of the first byte of the memory location is specified by DI/EDI and DS registers. (The size of the store address depends on the address-size attribute.)

The most significant bit in each byte of the mask operand determines whether the corresponding byte in the source operand is written to the corresponding byte location in memory: 0 indicates no write and 1 indicates write.

The MASKMOVQ instruction generates a non-temporal hint to the processor to minimize cache pollution. The non-temporal hint is implemented by using a write combining (WC) memory type protocol (see “Caching of Temporal vs. Non-Temporal Data” in Chapter 10, of the *Intel® 64 and IA-32 Architectures Software Developer’s Manual, Volume 1*). Because the WC protocol uses a weakly-ordered memory consistency model, a fencing operation implemented with the SFENCE or MFENCE instruction should be used in conjunction with MASKMOVQ instructions if multiple processors might use different memory types to read/write the destination memory locations.

This instruction causes a transition from x87 FPU to MMX technology state (that is, the x87 FPU top-of-stack pointer is set to 0 and the x87 FPU tag word is set to all 0s [valid]).

The behavior of the MASKMOVQ instruction with a mask of all 0s is as follows:

- No data will be written to memory.
- Transition from x87 FPU to MMX technology state will occur.
- Exceptions associated with addressing memory and page faults may still be signaled (implementation dependent).
- Signaling of breakpoints (code or data) is not guaranteed (implementation dependent).
- If the destination memory region is mapped as UC or WP, enforcement of associated semantics for these memory types is not guaranteed (that is, is reserved) and is implementation-specific.

The MASKMOVQ instruction can be used to improve performance for algorithms that need to merge data on a byte-by-byte basis. It should not cause a read for ownership; doing so generates unnecessary bandwidth since data is to be written directly using the byte-mask without allocating old data prior to the store.

In 64-bit mode, the memory address is specified by DS:RDI.

Operation

```
IF (MASK[7] = 1)
    THEN DEST[DI/EDI] ← SRC[7:0] ELSE (* Memory location unchanged *); FI;
IF (MASK[15] = 1)
    THEN DEST[DI/EDI + 1] ← SRC[15:8] ELSE (* Memory location unchanged *); FI;
    (* Repeat operation for 3rd through 6th bytes in source operand *)
IF (MASK[63] = 1)
    THEN DEST[DI/EDI + 15] ← SRC[63:56] ELSE (* Memory location unchanged *); FI;
```

Intel C/C++ Compiler Intrinsic Equivalent

```
void _mm_maskmove_si64(__m64d, __m64n, char * p)
```

Protected Mode Exceptions

#GP(0)	For an illegal memory operand effective address in the CS, DS, ES, FS or GS segments (even if mask is all 0s). If the destination operand is in a nonwritable segment. If the DS, ES, FS, or GS register contains a NULL segment selector.
#SS(0)	For an illegal address in the SS segment (even if mask is all 0s).
#PF(fault-code)	For a page fault (implementation specific).
#NM	If CR0.TS[bit 3] = 1.
#MF	If there is a pending FPU exception.
#UD	If CR0.EM[bit 2] = 1. If CR4.OSFXSR[bit 9] = 0. If CPUID.01H: EDX.SSE[bit 25] = 0. If Mod field of the ModR/M byte not 11B. If the LOCK prefix is used.
#AC(0)	If alignment checking is enabled and an unaligned memory reference is made while the current privilege level is 3.

Real-Address Mode Exceptions

GP	If any part of the operand lies outside the effective address space from 0 to FFFFH. (even if mask is all 0s).
#NM	If CR0.TS[bit 3] = 1.

#MF	If there is a pending FPU exception.
#UD	If CR0.EM[bit 2] = 1. If CR4.OSFXSR[bit 9] = 0. If CPUID.01H: EDX.SSE[bit 25] = 0. If the LOCK prefix is used.

Virtual-8086 Mode Exceptions

Same exceptions as in real address mode.

#PF(fault-code)	For a page fault (implementation specific).
#AC(0)	If alignment checking is enabled and an unaligned memory reference is made.

Compatibility Mode Exceptions

Same exceptions as in protected mode.

64-Bit Mode Exceptions

#GP(0)	If the memory address is in a non-canonical form.
#SS(0)	If a memory address referencing the SS segment is in a non-canonical form.
#PF(fault-code)	For a page fault (implementation specific).
#NM	If CR0.TS[bit 3] = 1.
#MF	If there is a pending FPU exception.
#UD	If CR0.EM[bit 2] = 1. If CR4.OSFXSR[bit 9] = 0. If CPUID.01H: EDX.SSE[bit 25] = 0. If Mod field of the ModR/M byte not 11B. If the LOCK prefix is used.
#AC(0)	If alignment checking is enabled and an unaligned memory reference is made while the current privilege level is 3.

MAXPD—Return Maximum Packed Double-Precision Floating-Point Values

Opcode	Instruction	64-Bit Mode	Compat/ Leg Mode	Description
66 0F 5F /r	MAXPD <i>xmm1</i> , <i>xmm2/m128</i>	Valid	Valid	Return the maximum double-precision floating-point values between <i>xmm2/m128</i> and <i>xmm1</i> .

Description

Performs a SIMD compare of the packed double-precision floating-point values in the destination operand (first operand) and the source operand (second operand), and returns the maximum value for each pair of values to the destination operand. The source operand can be an XMM register or a 128-bit memory location. The destination operand is an XMM register.

If the values being compared are both 0.0s (of either sign), the value in the second operand (source operand) is returned. If a value in the second operand is an SNaN, that SNaN is forwarded unchanged to the destination (that is, a QNaN version of the SNaN is not returned).

If only one value is a NaN (SNaN or QNaN) for this instruction, the second operand (source operand), either a NaN or a valid floating-point value, is written to the result. If instead of this behavior, it is required that the NaN source operand (from either the first or second operand) be returned, the action of MAXPD can be emulated using a sequence of instructions, such as, a comparison followed by AND, ANDN and OR.

In 64-bit mode, use of the REX.R prefix permits this instruction to access additional registers (XMM8-XMM15).

Operation

```

DEST[63:0] ← IF ((DEST[63:0] = 0.0) and (SRC[63:0] = 0.0))
              THEN SRC[63:0];
              ELSE IF (DEST[63:0] = SNaN) THEN SRC[63:0]; FI;
              ELSE IF (SRC[63:0] = SNaN) THEN SRC[63:0]; FI;
              ELSE IF (DEST[63:0] > SRC[63:0])
                THEN DEST[63:0];
                ELSE SRC[63:0]; FI; FI;

DEST[127:64] ← IF ((DEST[127:64] = 0.0) and (SRC[127:64] = 0.0))
                THEN SRC[127:64];
                ELSE IF (DEST[127:64] = SNaN) THEN SRC[127:64]; FI;
                ELSE IF (SRC[127:64] = SNaN) THEN SRC[127:64]; FI;
                ELSE IF (DEST[127:64] > SRC[63:0])
                  THEN DEST[127:64];

```

ELSE SRC[127:64]; FI; FI;

Intel C/C++ Compiler Intrinsic Equivalent

MAXPD `__m128d _mm_max_pd(__m128d a, __m128d b)`

SIMD Floating-Point Exceptions

Invalid (including QNaN source operand), Denormal.

Protected Mode Exceptions

#GP(0)	For an illegal memory operand effective address in the CS, DS, ES, FS or GS segments. If a memory operand is not aligned on a 16-byte boundary, regardless of segment.
#SS(0)	If a memory operand effective address is outside the SS segment limit.
#PF(fault-code)	For a page fault.
#NM	If CR0.TS[bit 3] = 1.
#XM	If an unmasked SIMD floating-point exception and CR4.OSXMMEXCPT[bit 10] = 1.
#UD	If an unmasked SIMD floating-point exception and CR4.OSXMMEXCPT[bit 10] = 0. If CR0.EM[bit 2] = 1. If CR4.OSFXSR[bit 9] = 0. If CPUID.01H:EDX.SSE2[bit 26] = 0. If the LOCK prefix is used.

Real-Address Mode Exceptions

#GP	If a memory operand is not aligned on a 16-byte boundary, regardless of segment. If any part of the operand lies outside the effective address space from 0 to FFFFH.
#NM	If CR0.TS[bit 3] = 1.
#XM	If an unmasked SIMD floating-point exception and CR4.OSXMMEXCPT[bit 10] = 1.
#UD	If an unmasked SIMD floating-point exception and CR4.OSXMMEXCPT[bit 10] = 0. If CR0.EM[bit 2] = 1. If CR4.OSFXSR[bit 9] = 0. If CPUID.01H:EDX.SSE2[bit 26] = 0. If the LOCK prefix is used.

Virtual-8086 Mode Exceptions

Same exceptions as in real address mode.

#PF(fault-code) For a page fault.

Compatibility Mode Exceptions

Same exceptions as in protected mode.

64-Bit Mode Exceptions

#SS(0)	If a memory address referencing the SS segment is in a non-canonical form.
#GP(0)	If the memory address is in a non-canonical form. If memory operand is not aligned on a 16-byte boundary, regardless of segment.
#PF(fault-code)	For a page fault.
#NM	If $\text{CR0.TS}[\text{bit } 3] = 1$.
#XM	If an unmasked SIMD floating-point exception and $\text{CR4.OSXMMEXCPT}[\text{bit } 10] = 1$.
#UD	If an unmasked SIMD floating-point exception and $\text{CR4.OSXMMEXCPT}[\text{bit } 10] = 0$. If $\text{CR0.EM}[\text{bit } 2] = 1$. If $\text{CR4.OSFXSR}[\text{bit } 9] = 0$. If $\text{CPUID.01H:EDX.SSE2}[\text{bit } 26] = 0$. If the LOCK prefix is used.

MAXPS—Return Maximum Packed Single-Precision Floating-Point Values

Opcode	Instruction	64-Bit Mode	Compat/ Leg Mode	Description
OF 5F /r	MAXPS <i>xmm1</i> , <i>xmm2/m128</i>	Valid	Valid	Return the maximum single-precision floating-point values between <i>xmm2/m128</i> and <i>xmm1</i> .

Description

Performs a SIMD compare of the packed single-precision floating-point values in the destination operand (first operand) and the source operand (second operand), and returns the maximum value for each pair of values to the destination operand. The source operand can be an XMM register or a 128-bit memory location. The destination operand is an XMM register.

If the values being compared are both 0.0s (of either sign), the value in the second operand (source operand) is returned. If a value in the second operand is an SNaN, that SNaN is returned unchanged to the destination (that is, a QNaN version of the SNaN is not returned).

If only one value is a NaN (SNaN or QNaN) for this instruction, the second operand (source operand), either a NaN or a valid floating-point value, is written to the result. If instead of this behavior, it is required that the NaN source operand (from either the first or second operand) be returned, the action of MAXPS can be emulated using a sequence of instructions, such as, a comparison followed by AND, ANDN and OR.

In 64-bit mode, use of the REX.R prefix permits this instruction to access additional registers (XMM8-XMM15).

Operation

```
DEST[31:0] ← IF ((DEST[31:0] = 0.0) and (SRC[31:0] = 0.0))
              THEN SRC[31:0];
              ELSE IF (DEST[31:0] = SNaN) THEN SRC[31:0]; FI;
              ELSE IF (SRC[31:0] = SNaN) THEN SRC[31:0]; FI;
              ELSE IF (DEST[31:0] > SRC[31:0]); FI;
              THEN DEST[31:0];
              ELSE SRC[31:0]; FI; FI;
```

(* Repeat operation for 2nd and 3rd doublewords *);

```
DEST[127:64] ← IF ((DEST[127:96] = 0.0) and (SRC[127:96] = 0.0))
                THEN SRC[127:96];
                ELSE IF (DEST[127:96] = SNaN) THEN SRC[127:96];
                ELSE IF (SRC[127:96] = SNaN) THEN SRC[127:96];
                ELSE IF (DEST[127:96] > SRC[127:96])
```

THEN DEST[127:96];
 ELSE SRC[127:96]; FI; FI;

Intel C/C++ Compiler Intrinsic Equivalent

MAXPS `__m128d _mm_max_ps(__m128d a, __m128d b)`

SIMD Floating-Point Exceptions

Invalid (including QNaN source operand), Denormal.

Protected Mode Exceptions

#GP(0)	For an illegal memory operand effective address in the CS, DS, ES, FS or GS segments. If a memory operand is not aligned on a 16-byte boundary, regardless of segment.
#SS(0)	If a memory operand effective address is outside the SS segment limit.
#PF(fault-code)	For a page fault.
#NM	If CR0.TS[bit 3] = 1.
#XM	If an unmasked SIMD floating-point exception and CR4.OSXMMEXCPT[bit 10] = 1.
#UD	If an unmasked SIMD floating-point exception and CR4.OSXMMEXCPT[bit 10] = 0. If CR0.EM[bit 2] = 1. If CR4.OSFXSR[bit 9] = 0. If CPUID.01H: EDX.SSE[bit 25] = 0. If the LOCK prefix is used.

Real-Address Mode Exceptions

#GP	If a memory operand is not aligned on a 16-byte boundary, regardless of segment. If any part of the operand lies outside the effective address space from 0 to FFFFH.
#NM	If CR0.TS[bit 3] = 1.
#XM	If an unmasked SIMD floating-point exception and CR4.OSXMMEXCPT[bit 10] = 1.
#UD	If an unmasked SIMD floating-point exception and CR4.OSXMMEXCPT[bit 10] = 0. If CR0.EM[bit 2] = 1. If CR4.OSFXSR[bit 9] = 0.

If CPUID.01H: EDX.SSE[bit 25] = 0.
 If the LOCK prefix is used.

Virtual-8086 Mode Exceptions

Same exceptions as in real address mode.

#PF(fault-code) For a page fault.

Compatibility Mode Exceptions

Same exceptions as in protected mode.

64-Bit Mode Exceptions

#SS(0) If a memory address referencing the SS segment is in a non-canonical form.

#GP(0) If the memory address is in a non-canonical form.
 If memory operand is not aligned on a 16-byte boundary, regardless of segment.

#PF(fault-code) For a page fault.

#NM If CR0.TS[bit 3] = 1.

#XM If an unmasked SIMD floating-point exception and CR4.OSXMMEXCPT[bit 10] = 1.

#UD If an unmasked SIMD floating-point exception and CR4.OSXMMEXCPT[bit 10] = 0.
 If CR0.EM[bit 2] = 1.
 If CR4.OSFXSR[bit 9] = 0.
 If CPUID.01H: EDX.SSE[bit 25] = 0.
 If the LOCK prefix is used.

MAXSD—Return Maximum Scalar Double-Precision Floating-Point Value

Opcode	Instruction	64-Bit Mode	Compat/ Leg Mode	Description
F2 0F 5F /r	MAXSD <i>xmm1</i> , <i>xmm2/m64</i>	Valid	Valid	Return the maximum scalar double-precision floating-point value between <i>xmm2/mem64</i> and <i>xmm1</i> .

Description

Compares the low double-precision floating-point values in the destination operand (first operand) and the source operand (second operand), and returns the maximum value to the low quadword of the destination operand. The source operand can be an XMM register or a 64-bit memory location. The destination operand is an XMM register. When the source operand is a memory operand, only 64 bits are accessed. The high quadword of the destination operand remains unchanged.

If the values being compared are both 0.0s (of either sign), the value in the second operand (source operand) is returned. If a value in the second operand is an SNaN, that SNaN is returned unchanged to the destination (that is, a QNaN version of the SNaN is not returned).

If only one value is a NaN (SNaN or QNaN) for this instruction, the second operand (source operand), either a NaN or a valid floating-point value, is written to the result. If instead of this behavior, it is required that the NaN source operand (from either the first or second operand) be returned, the action of MAXSD can be emulated using a sequence of instructions, such as, a comparison followed by AND, ANDN and OR.

In 64-bit mode, use of the REX.R prefix permits this instruction to access additional registers (XMM8-XMM15).

Operation

```
DEST[63:0] ← IF ((DEST[63:0] = 0.0) and (SRC[63:0] = 0.0))
              THEN SRC[63:0]; FI;
              IF (DEST[63:0] = SNaN)
                THEN SRC[63:0];
                ELSE IF (SRC[63:0] = SNaN)
                  THEN SRC[63:0]; FI;
                  ELSE IF (DEST[63:0] > SRC[63:0])
                    THEN DEST[63:0];
                    ELSE SRC[63:0]; FI; FI;
```

(* DEST[127:64] is unchanged *);

Intel C/C++ Compiler Intrinsic Equivalent

MAXSD `__m128d _mm_max_sd(__m128d a, __m128d b)`

SIMD Floating-Point Exceptions

Invalid (including QNaN source operand), Denormal.

Protected Mode Exceptions

#GP(0)	For an illegal memory operand effective address in the CS, DS, ES, FS or GS segments.
#SS(0)	If a memory operand effective address is outside the SS segment limit.
#PF(fault-code)	For a page fault.
#NM	If CR0.TS[bit 3] = 1.
#XM	If an unmasked SIMD floating-point exception and CR4.OSXMMEXCPT[bit 10] = 1.
#UD	If an unmasked SIMD floating-point exception and CR4.OSXMMEXCPT[bit 10] = 0. If CR0.EM[bit 2] = 1. If CR4.OSFXSR[bit 9] = 0. If CPUID.01H:EDX.SSE2[bit 26] = 0. If the LOCK prefix is used.
#AC(0)	If alignment checking is enabled and an unaligned memory reference is made while the current privilege level is 3.

Real-Address Mode Exceptions

GP	If any part of the operand lies outside the effective address space from 0 to FFFFH.
#NM	If CR0.TS[bit 3] = 1.
#XM	If an unmasked SIMD floating-point exception and CR4.OSXMMEXCPT[bit 10] = 1.
#UD	If an unmasked SIMD floating-point exception and CR4.OSXMMEXCPT[bit 10] = 0. If CR0.EM[bit 2] = 1. If CR4.OSFXSR[bit 9] = 0. If CPUID.01H:EDX.SSE2[bit 26] = 0. If the LOCK prefix is used.

Virtual-8086 Mode Exceptions

Same exceptions as in real address mode.

- #PF(fault-code) For a page fault.
- #AC(0) If alignment checking is enabled and an unaligned memory reference is made.

Compatibility Mode Exceptions

Same exceptions as in protected mode.

64-Bit Mode Exceptions

- #SS(0) If a memory address referencing the SS segment is in a non-canonical form.
- #GP(0) If the memory address is in a non-canonical form.
- #PF(fault-code) For a page fault.
- #NM If $CR0.TS[\text{bit } 3] = 1$.
- #XM If an unmasked SIMD floating-point exception and $CR4.OSXMMEXCPT[\text{bit } 10] = 1$.
- #UD If an unmasked SIMD floating-point exception and $CR4.OSXMMEXCPT[\text{bit } 10] = 0$.
If $CR0.EM[\text{bit } 2] = 1$.
If $CR4.OSFXSR[\text{bit } 9] = 0$.
If $CPUID.01H:EDX.SSE2[\text{bit } 26] = 0$.
If the LOCK prefix is used.
- #AC(0) If alignment checking is enabled and an unaligned memory reference is made while the current privilege level is 3.

MAXSS—Return Maximum Scalar Single-Precision Floating-Point Value

Opcode	Instruction	64-Bit Mode	Compat/Leg Mode	Description
F3 0F 5F /r	MAXSS <i>xmm1</i> , <i>xmm2/m32</i>	Valid	Valid	Return the maximum scalar single-precision floating-point value between <i>xmm2/mem32</i> and <i>xmm1</i> .

Description

Compares the low single-precision floating-point values in the destination operand (first operand) and the source operand (second operand), and returns the maximum value to the low doubleword of the destination operand. The source operand can be an XMM register or a 32-bit memory location. The destination operand is an XMM register. When the source operand is a memory operand, only 32 bits are accessed. The three high-order doublewords of the destination operand remain unchanged.

If the values being compared are both 0.0s (of either sign), the value in the second operand (source operand) is returned. If a value in the second operand is an SNaN, that SNaN is returned unchanged to the destination (that is, a QNaN version of the SNaN is not returned).

If only one value is a NaN (SNaN or QNaN) for this instruction, the second operand (source operand), either a NaN or a valid floating-point value, is written to the result. If instead of this behavior, it is required that the NaN source operand (from either the first or second operand) be returned, the action of MAXSS can be emulated using a sequence of instructions, such as, a comparison followed by AND, ANDN and OR.

In 64-bit mode, use of the REX.R prefix permits this instruction to access additional registers (XMM8-XMM15).

Operation

```
DEST[63:0] ← IF ((DEST[31:0] = 0.0) and (SRC[31:0] = 0.0))
              THEN SRC[31:0];
              ELSE IF (DEST[31:0] = SNaN) THEN SRC[31:0]; FI;
              ELSE IF (SRC[31:0] = SNaN) THEN SRC[31:0]; FI;
              ELSE IF (DEST[31:0] > SRC[31:0])
                  THEN DEST[31:0]
                  ELSE SRC[31:0]; FI; FI;
(* DEST[127:32] is unchanged *)
```

Intel C/C++ Compiler Intrinsic Equivalent

```
__m128d _mm_max_ss(__m128d a, __m128d b)
```

SIMD Floating-Point Exceptions

Invalid (including QNaN source operand), Denormal.

Protected Mode Exceptions

#GP(0)	For an illegal memory operand effective address in the CS, DS, ES, FS or GS segments.
#SS(0)	If a memory operand effective address is outside the SS segment limit.
#PF(fault-code)	For a page fault.
#NM	If CR0.TS[bit 3] = 1.
#XM	If an unmasked SIMD floating-point exception and CR4.OSXMMEXCPT[bit 10] = 1.
#UD	If an unmasked SIMD floating-point exception and CR4.OSXMMEXCPT[bit 10] = 0. If CR0.EM[bit 2] = 1. If CR4.OSFXSR[bit 9] = 0. If CPUID.01H:EDX.SSE[bit 25] = 0. If the LOCK prefix is used.
#AC(0)	If alignment checking is enabled and an unaligned memory reference is made while the current privilege level is 3.

Real-Address Mode Exceptions

GP	If any part of the operand lies outside the effective address space from 0 to FFFFH.
#NM	If CR0.TS[bit 3] = 1.
#XM	If an unmasked SIMD floating-point exception and CR4.OSXMMEXCPT[bit 10] = 1.
#UD	If an unmasked SIMD floating-point exception and CR4.OSXMMEXCPT[bit 10] = 0. If CR0.EM[bit 2] = 1. If CR4.OSFXSR[bit 9] = 0. If CPUID.01H:EDX.SSE[bit 25] = 0. If the LOCK prefix is used.

Virtual-8086 Mode Exceptions

Same exceptions as in real address mode.

#PF(fault-code)	For a page fault.
#AC(0)	If alignment checking is enabled and an unaligned memory reference is made.

Compatibility Mode Exceptions

Same exceptions as in protected mode.

64-Bit Mode Exceptions

#SS(0)	If a memory address referencing the SS segment is in a non-canonical form.
#GP(0)	If the memory address is in a non-canonical form.
#PF(fault-code)	For a page fault.
#NM	If $\text{CR0.TS}[\text{bit } 3] = 1$.
#XM	If an unmasked SIMD floating-point exception and $\text{CR4.OSXMMEXCPT}[\text{bit } 10] = 1$.
#UD	If an unmasked SIMD floating-point exception and $\text{CR4.OSXMMEXCPT}[\text{bit } 10] = 0$. If $\text{CR0.EM}[\text{bit } 2] = 1$. If $\text{CR4.OSFXSR}[\text{bit } 9] = 0$. If $\text{CPUID.01H:EDX.SSE}[\text{bit } 25] = 0$. If the LOCK prefix is used.
#AC(0)	If alignment checking is enabled and an unaligned memory reference is made while the current privilege level is 3.

MFENCE—Memory Fence

Opcode	Instruction	64-Bit Mode	Compat/Leg Mode	Description
OF AE /6	MFENCE	Valid	Valid	Serializes load and store operations.

Description

Performs a serializing operation on all load-from-memory and store-to-memory instructions that were issued prior the MFENCE instruction. This serializing operation guarantees that every load and store instruction that precedes in program order the MFENCE instruction is globally visible before any load or store instruction that follows the MFENCE instruction is globally visible. The MFENCE instruction is ordered with respect to all load and store instructions, other MFENCE instructions, any SFENCE and LFENCE instructions, and any serializing instructions (such as the CPUID instruction).

Weakly ordered memory types can be used to achieve higher processor performance through such techniques as out-of-order issue, speculative reads, write-combining, and write-collapsing. The degree to which a consumer of data recognizes or knows that the data is weakly ordered varies among applications and may be unknown to the producer of this data. The MFENCE instruction provides a performance-efficient way of ensuring load and store ordering between routines that produce weakly-ordered results and routines that consume that data.

It should be noted that processors are free to speculatively fetch and cache data from system memory regions that are assigned a memory-type that permits speculative reads (that is, the WB, WC, and WT memory types). The PREFETCH h instruction is considered a hint to this speculative behavior. Because this speculative fetching can occur at any time and is not tied to instruction execution, the MFENCE instruction is not ordered with respect to PREFETCH h instructions or any other speculative fetching mechanism (that is, data could be speculatively loaded into the cache just before, during, or after the execution of an MFENCE instruction).

This instruction's operation is the same in non-64-bit modes and 64-bit mode.

Operation

Wait_On_Following_Loads_And_Stores_Until(preceding_loads_and_stores_globally_visible);

Intel C/C++ Compiler Intrinsic Equivalent

```
void _mm_mfence(void)
```

Exceptions (All Modes of Operation)

#UD If CPUID.01H: EDX.SSE2[bit 26] = 0.
 If the LOCK prefix is used.

MINPD—Return Minimum Packed Double-Precision Floating-Point Values

Opcode	Instruction	64-Bit Mode	Compat/ Leg Mode	Description
66 0F 5D /r	MINPD <i>xmm1</i> , <i>xmm2/m128</i>	Valid	Valid	Return the minimum double-precision floating-point values between <i>xmm2/m128</i> and <i>xmm1</i> .

Description

Performs a SIMD compare of the packed double-precision floating-point values in the destination operand (first operand) and the source operand (second operand), and returns the minimum value for each pair of values to the destination operand. The source operand can be an XMM register or a 128-bit memory location. The destination operand is an XMM register.

If the values being compared are both 0.0s (of either sign), the value in the second operand (source operand) is returned. If a value in the second operand is an SNaN, that SNaN is returned unchanged to the destination (that is, a QNaN version of the SNaN is not returned).

If only one value is a NaN (SNaN or QNaN) for this instruction, the second operand (source operand), either a NaN or a valid floating-point value, is written to the result. If instead of this behavior, it is required that the NaN source operand (from either the first or second operand) be returned, the action of MINPD can be emulated using a sequence of instructions, such as, a comparison followed by AND, ANDN and OR.

In 64-bit mode, use of the REX.R prefix permits this instruction to access additional registers (XMM8-XMM15).

Operation

```
DEST[63:0] ← IF ((DEST[63:0] = 0.0) and (SRC[63:0] = 0.0))
              THEN SRC[63:0]; FI;
              ELSE IF (DEST[63:0] = SNaN) THEN SRC[63:0]; FI;
              ELSE IF (SRC[63:0] = SNaN) THEN SRC[63:0]; FI;
              ELSE IF (DEST[63:0] < SRC[63:0])
                THEN DEST[63:0]
                ELSE SRC[63:0]; FI; FI;
```

```
DEST[127:64] ← IF ((DEST[127:64] = 0.0) and (SRC[127:64] = 0.0))
                THEN SRC[127:64]; FI;
                ELSE IF (DEST[127:64] = SNaN) THEN SRC[127:64]; FI;
                ELSE IF (SRC[127:64] = SNaN) THEN SRC[127:64]; FI;
                ELSE IF (DEST[127:64] < SRC[63:0])
```

THEN DEST[127:64]
 ELSE SRC[127:64]; FI; FI;

Intel C/C++ Compiler Intrinsic Equivalent

MINPD `__m128d _mm_min_pd(__m128d a, __m128d b)`

SIMD Floating-Point Exceptions

Invalid (including QNaN source operand), Denormal.

Protected Mode Exceptions

#GP(0)	For an illegal memory operand effective address in the CS, DS, ES, FS or GS segments. If a memory operand is not aligned on a 16-byte boundary, regardless of segment.
#SS(0)	If a memory operand effective address is outside the SS segment limit.
#PF(fault-code)	For a page fault.
#NM	If CR0.TS[bit 3] = 1.
#XM	If an unmasked SIMD floating-point exception and CR4.OSXMMEXCPT[bit 10] = 1.
#UD	If an unmasked SIMD floating-point exception and CR4.OSXMMEXCPT[bit 10] = 0. If CR0.EM[bit 2] = 1. If CR4.OSFXSR[bit 9] = 0. If CPUID.01H:EDX.SSE2[bit 26] = 0. If the LOCK prefix is used.

Real-Address Mode Exceptions

#GP	If a memory operand is not aligned on a 16-byte boundary, regardless of segment. If any part of the operand lies outside the effective address space from 0 to FFFFH.
#NM	If CR0.TS[bit 3] = 1.
#XM	If an unmasked SIMD floating-point exception and CR4.OSXMMEXCPT[bit 10] = 1.
#UD	If an unmasked SIMD floating-point exception and CR4.OSXMMEXCPT[bit 10] = 0. If CR0.EM[bit 2] = 1. If CR4.OSFXSR[bit 9] = 0.

If CPUID.01H: EDX.SSE2[bit 26] = 0.
 If the LOCK prefix is used.

Virtual-8086 Mode Exceptions

Same exceptions as in real address mode.

#PF(fault-code) For a page fault.

Compatibility Mode Exceptions

Same exceptions as in protected mode.

64-Bit Mode Exceptions

#SS(0) If a memory address referencing the SS segment is in a non-canonical form.

#GP(0) If the memory address is in a non-canonical form.
 If memory operand is not aligned on a 16-byte boundary, regardless of segment.

#PF(fault-code) For a page fault.

#NM If CR0.TS[bit 3] = 1.

#XM If an unmasked SIMD floating-point exception and CR4.OSXMMEXCPT[bit 10] = 1.

#UD If an unmasked SIMD floating-point exception and CR4.OSXMMEXCPT[bit 10] = 0.
 If CR0.EM[bit 2] = 1.
 If CR4.OSFXSR[bit 9] = 0.
 If CPUID.01H: EDX.SSE2[bit 26] = 0.
 If the LOCK prefix is used.

MINPS—Return Minimum Packed Single-Precision Floating-Point Values

Opcode	Instruction	64-Bit Mode	Compat/Leg Mode	Description
OF 5D /r	MINPS <i>xmm1</i> , <i>xmm2/m128</i>	Valid	Valid	Return the minimum single-precision floating-point values between <i>xmm2/m128</i> and <i>xmm1</i> .

Description

Performs a SIMD compare of the packed single-precision floating-point values in the destination operand (first operand) and the source operand (second operand), and returns the minimum value for each pair of values to the destination operand. The source operand can be an XMM register or a 128-bit memory location. The destination operand is an XMM register.

If the values being compared are both 0.0s (of either sign), the value in the second operand (source operand) is returned. If a value in the second operand is an SNaN, that SNaN is returned unchanged to the destination (that is, a QNaN version of the SNaN is not returned).

If only one value is a NaN (SNaN or QNaN) for this instruction, the second operand (source operand), either a NaN or a valid floating-point value, is written to the result. If instead of this behavior, it is required that the NaN source operand (from either the first or second operand) be returned, the action of MINPS can be emulated using a sequence of instructions, such as, a comparison followed by AND, ANDN and OR.

In 64-bit mode, use of the REX.R prefix permits this instruction to access additional registers (XMM8-XMM15).

Operation

```
DEST[63:0] ← IF ((DEST[31:0] = 0.0) and (SRC[31:0] = 0.0))
              THEN SRC[31:0];
              ELSE IF (DEST[31:0] = SNaN) THEN SRC[31:0]; FI;
              ELSE IF (SRC[31:0] = SNaN) THEN SRC[31:0]; FI;
              ELSE IF (DEST[31:0] > SRC[31:0])
                  THEN DEST[31:0]
                  ELSE SRC[31:0]; FI; FI;
```

(* Repeat operation for 2nd and 3rd doublewords *);

```
DEST[127:64] ← IF ((DEST[127:96] = 0.0) and (SRC[127:96] = 0.0))
                THEN SRC[127:96];
                ELSE IF (DEST[127:96] = SNaN) THEN SRC[127:96]; FI;
                ELSE IF (SRC[127:96] = SNaN) THEN SRC[127:96]; FI;
                ELSE IF (DEST[127:96] < SRC[127:96])
```

THEN DEST[127:96]
 ELSE SRC[127:96]; FI; FI;

Intel C/C++ Compiler Intrinsic Equivalent

MINPS `__m128d _mm_min_ps(__m128d a, __m128d b)`

SIMD Floating-Point Exceptions

Invalid (including QNaN source operand), Denormal.

Protected Mode Exceptions

#GP(0)	For an illegal memory operand effective address in the CS, DS, ES, FS or GS segments. If a memory operand is not aligned on a 16-byte boundary, regardless of segment.
#SS(0)	If a memory operand effective address is outside the SS segment limit.
#PF(fault-code)	For a page fault.
#NM	If CR0.TS[bit 3] = 1.
#XM	If an unmasked SIMD floating-point exception and CR4.OSXMMEXCPT[bit 10] = 1.
#UD	If an unmasked SIMD floating-point exception and CR4.OSXMMEXCPT[bit 10] = 0. If CR0.EM[bit 2] = 1. If CR4.OSFXSR[bit 9] = 0. If CPUID.01H: EDX.SSE[bit 25] = 0. If the LOCK prefix is used.

Real-Address Mode Exceptions

#GP	If a memory operand is not aligned on a 16-byte boundary, regardless of segment. If any part of the operand lies outside the effective address space from 0 to FFFFH.
#NM	If CR0.TS[bit 3] = 1.
#XM	If an unmasked SIMD floating-point exception and CR4.OSXMMEXCPT[bit 10] = 1.
#UD	If an unmasked SIMD floating-point exception and CR4.OSXMMEXCPT[bit 10] = 0. If CR0.EM[bit 2] = 1. If CR4.OSFXSR[bit 9] = 0.

If CPUID.01H: EDX.SSE[bit 25] = 0.
If the LOCK prefix is used.

Virtual-8086 Mode Exceptions

Same exceptions as in real address mode.

#PF(fault-code) For a page fault.

Compatibility Mode Exceptions

Same exceptions as in protected mode.

64-Bit Mode Exceptions

#SS(0)	If a memory address referencing the SS segment is in a non-canonical form.
#GP(0)	If the memory address is in a non-canonical form. If memory operand is not aligned on a 16-byte boundary, regardless of segment.
#PF(fault-code)	For a page fault.
#NM	If CR0.TS[bit 3] = 1.
#XM	If an unmasked SIMD floating-point exception and CR4.OSXMMEXCPT[bit 10] = 1.
#UD	If an unmasked SIMD floating-point exception and CR4.OSXMMEXCPT[bit 10] = 0. If CR0.EM[bit 2] = 1. If CR4.OSFXSR[bit 9] = 0. If CPUID.01H: EDX.SSE[bit 25] = 0. If the LOCK prefix is used.

MINSD—Return Minimum Scalar Double-Precision Floating-Point Value

Opcode	Instruction	64-Bit Mode	Compat/Leg Mode	Description
F2 0F 5D /r	MINSD <i>xmm1</i> , <i>xmm2/m64</i>	Valid	Valid	Return the minimum scalar double-precision floating-point value between <i>xmm2/mem64</i> and <i>xmm1</i> .

Description

Compares the low double-precision floating-point values in the destination operand (first operand) and the source operand (second operand), and returns the minimum value to the low quadword of the destination operand. The source operand can be an XMM register or a 64-bit memory location. The destination operand is an XMM register. When the source operand is a memory operand, only the 64 bits are accessed. The high quadword of the destination operand remains unchanged.

If the values being compared are both 0.0s (of either sign), the value in the second operand (source operand) is returned. If a value in the second operand is an SNaN, that SNaN is returned unchanged to the destination (that is, a QNaN version of the SNaN is not returned).

If only one value is a NaN (SNaN or QNaN) for this instruction, the second operand (source operand), either a NaN or a valid floating-point value, is written to the result. If instead of this behavior, it is required that the NaN source operand (from either the first or second operand) be returned, the action of MINSD can be emulated using a sequence of instructions, such as, a comparison followed by AND, ANDN and OR.

In 64-bit mode, use of the REX.R prefix permits this instruction to access additional registers (XMM8-XMM15).

Operation

```
DEST[63:0] ← IF ((DEST[63:0] = 0.0) and (SRC[63:0] = 0.0))
              THEN SRC[63:0];
              ELSE IF (DEST[63:0] = SNaN) THEN SRC[63:0]; FI;
              ELSE IF (SRC[63:0] = SNaN) THEN SRC[63:0]; FI;
              ELSE IF (DEST[63:0] < SRC[63:0])
                  THEN DEST[63:0];
                  ELSE SRC[63:0]; FI; FI;
```

(* DEST[127:64] is unchanged *);

Intel C/C++ Compiler Intrinsic Equivalent

```
MINSD    __m128d _mm_min_sd(__m128d a, __m128d b)
```

SIMD Floating-Point Exceptions

Invalid (including QNaN source operand), Denormal.

Protected Mode Exceptions

#GP(0)	For an illegal memory operand effective address in the CS, DS, ES, FS or GS segments.
#SS(0)	If a memory operand effective address is outside the SS segment limit.
#PF(fault-code)	For a page fault.
#NM	If CR0.TS[bit 3] = 1.
#XM	If an unmasked SIMD floating-point exception and CR4.OSXMMEXCPT[bit 10] = 1.
#UD	If an unmasked SIMD floating-point exception and CR4.OSXMMEXCPT[bit 10] = 0. If CR0.EM[bit 2] = 1. If CR4.OSFXSR[bit 9] = 0. If CPUID.01H:EDX.SSE2[bit 26] = 0. If the LOCK prefix is used.
#AC(0)	If alignment checking is enabled and an unaligned memory reference is made while the current privilege level is 3.

Real-Address Mode Exceptions

GP	If any part of the operand lies outside the effective address space from 0 to FFFFH.
#NM	If CR0.TS[bit 3] = 1.
#XM	If an unmasked SIMD floating-point exception and CR4.OSXMMEXCPT[bit 10] = 1.
#UD	If an unmasked SIMD floating-point exception and CR4.OSXMMEXCPT[bit 10] = 0. If CR0.EM[bit 2] = 1. If CR4.OSFXSR[bit 9] = 0. If CPUID.01H:EDX.SSE2[bit 26] = 0. If the LOCK prefix is used.

Virtual-8086 Mode Exceptions

Same exceptions as in real address mode.

#PF(fault-code)	For a page fault.
#AC(0)	If alignment checking is enabled and an unaligned memory reference is made.

Compatibility Mode Exceptions

Same exceptions as in protected mode.

64-Bit Mode Exceptions

#SS(0)	If a memory address referencing the SS segment is in a non-canonical form.
#GP(0)	If the memory address is in a non-canonical form.
#PF(fault-code)	For a page fault.
#NM	If $\text{CR0.TS}[\text{bit } 3] = 1$.
#XM	If an unmasked SIMD floating-point exception and $\text{CR4.OSXMMEXCPT}[\text{bit } 10] = 1$.
#UD	If an unmasked SIMD floating-point exception and $\text{CR4.OSXMMEXCPT}[\text{bit } 10] = 0$. If $\text{CR0.EM}[\text{bit } 2] = 1$. If $\text{CR4.OSFXSR}[\text{bit } 9] = 0$. If $\text{CPUID.01H:EDX.SSE2}[\text{bit } 26] = 0$. If the LOCK prefix is used.
#AC(0)	If alignment checking is enabled and an unaligned memory reference is made while the current privilege level is 3.

MINSS—Return Minimum Scalar Single-Precision Floating-Point Value

Opcode	Instruction	64-Bit Mode	Compat/Leg Mode	Description
F3 0F 5D /r	MINSS <i>xmm1</i> , <i>xmm2/m32</i>	Valid	Valid	Return the minimum scalar single-precision floating-point value between <i>xmm2/mem32</i> and <i>xmm1</i> .

Description

Compares the low single-precision floating-point values in the destination operand (first operand) and the source operand (second operand), and returns the minimum value to the low doubleword of the destination operand. The source operand can be an XMM register or a 32-bit memory location. The destination operand is an XMM register. When the source operand is a memory operand, only 32 bits are accessed. The three high-order doublewords of the destination operand remain unchanged.

If the values being compared are both 0.0s (of either sign), the value in the second operand (source operand) is returned. If a value in the second operand is an SNaN, that SNaN is returned unchanged to the destination (that is, a QNaN version of the SNaN is not returned).

If only one value is a NaN (SNaN or QNaN) for this instruction, the second operand (source operand), either a NaN or a valid floating-point value, is written to the result. If instead of this behavior, it is required that the NaN source operand (from either the first or second operand) be returned, the action of MINSD can be emulated using a sequence of instructions, such as, a comparison followed by AND, ANDN and OR.

In 64-bit mode, use of the REX.R prefix permits this instruction to access additional registers (XMM8-XMM15).

Operation

```
DEST[63:0] ← IF ((DEST[31:0] = 0.0) AND (SRC[31:0] = 0.0))
              THEN SRC[31:0];
              ELSE IF (DEST[31:0] = SNaN) THEN SRC[31:0]; FI;
              ELSE IF (SRC[31:0] = SNaN) THEN SRC[31:0]; FI;
              ELSE IF (DEST[31:0] < SRC[31:0])
                  THEN DEST[31:0]
                  ELSE SRC[31:0]; FI; FI;
```

(* DEST[127:32] is unchanged *);

Intel C/C++ Compiler Intrinsic Equivalent

```
MINSS    __m128d _mm_min_ss(__m128d a, __m128d b)
```

SIMD Floating-Point Exceptions

Invalid (including QNaN source operand), Denormal.

Protected Mode Exceptions

#GP(0)	For an illegal memory operand effective address in the CS, DS, ES, FS or GS segments.
#SS(0)	If a memory operand effective address is outside the SS segment limit.
#PF(fault-code)	For a page fault.
#NM	If CR0.TS[bit 3] = 1.
#XM	If an unmasked SIMD floating-point exception and CR4.OSXMMEXCPT[bit 10] = 1.
#UD	If an unmasked SIMD floating-point exception and CR4.OSXMMEXCPT[bit 10] = 0. If CR0.EM[bit 2] = 1. If CR4.OSFXSR[bit 9] = 0. If CPUID.01H:EDX.SSE[bit 25] = 0. If the LOCK prefix is used.
#AC(0)	If alignment checking is enabled and an unaligned memory reference is made while the current privilege level is 3.

Real-Address Mode Exceptions

GP	If any part of the operand lies outside the effective address space from 0 to FFFFH.
#NM	If CR0.TS[bit 3] = 1.
#XM	If an unmasked SIMD floating-point exception and CR4.OSXMMEXCPT[bit 10] = 1.
#UD	If an unmasked SIMD floating-point exception and CR4.OSXMMEXCPT[bit 10] = 0. If CR0.EM[bit 2] = 1. If CR4.OSFXSR[bit 9] = 0. If CPUID.01H:EDX.SSE[bit 25] = 0. If the LOCK prefix is used.

Virtual-8086 Mode Exceptions

Same exceptions as in real address mode.

#PF(fault-code)	For a page fault.
#AC(0)	If alignment checking is enabled and an unaligned memory reference is made.

Compatibility Mode Exceptions

Same exceptions as in protected mode.

64-Bit Mode Exceptions

#SS(0)	If a memory address referencing the SS segment is in a non-canonical form.
#GP(0)	If the memory address is in a non-canonical form.
#PF(fault-code)	For a page fault.
#NM	If $\text{CR0.TS}[\text{bit } 3] = 1$.
#XM	If an unmasked SIMD floating-point exception and $\text{CR4.OSXMMEXCPT}[\text{bit } 10] = 1$.
#UD	If an unmasked SIMD floating-point exception and $\text{CR4.OSXMMEXCPT}[\text{bit } 10] = 0$. If $\text{CR0.EM}[\text{bit } 2] = 1$. If $\text{CR4.OSFXSR}[\text{bit } 9] = 0$. If $\text{CPUID.01H:EDX.SSE}[\text{bit } 25] = 0$. If the LOCK prefix is used.
#AC(0)	If alignment checking is enabled and an unaligned memory reference is made while the current privilege level is 3.

MONITOR—Set Up Monitor Address

Opcode	Instruction	64-Bit Mode	Compat/ Leg Mode	Description
0F 01 C8	MONITOR	Valid	Valid	Sets up a linear address range to be monitored by hardware and activates the monitor. The address range should be a write-back memory caching type. The address is DS:EAX (DS:RAX in 64-bit mode).

Description

The MONITOR instruction arms address monitoring hardware using an address specified in EAX (the address range that the monitoring hardware checks for store operations can be determined by using CPUID). A store to an address within the specified address range triggers the monitoring hardware. The state of monitor hardware is used by MWAIT.

The content of EAX is an effective address (in 64-bit mode, RAX is used). By default, the DS segment is used to create a linear address that is monitored. Segment overrides can be used.

ECX and EDX are also used. They communicate other information to MONITOR. ECX specifies optional extensions. EDX specifies optional hints; it does not change the architectural behavior of the instruction. For the Pentium 4 processor (family 15, model 3), no extensions or hints are defined. Undefined hints in EDX are ignored by the processor; undefined extensions in ECX raises a general protection fault.

The address range must use memory of the write-back type. Only write-back memory will correctly trigger the monitoring hardware. Additional information on determining what address range to use in order to prevent false wake-ups is described in Chapter 8, “Multiple-Processor Management” of the *Intel® 64 and IA-32 Architectures Software Developer’s Manual, Volume 3A*.

The MONITOR instruction is ordered as a load operation with respect to other memory transactions. The instruction is subject to the permission checking and faults associated with a byte load. Like a load, MONITOR sets the A-bit but not the D-bit in page tables.

The MONITOR CPUID feature flag (ECX bit 3; CPUID executed EAX = 1) indicates the availability of MONITOR and MWAIT in the processor. When set, MONITOR may be executed only at privilege level 0 (use at any other privilege level results in an invalid-opcode exception). The operating system or system BIOS may disable this instruction by using the IA32_MISC_ENABLES MSR; disabling MONITOR clears the CPUID feature flag and causes execution to generate an illegal opcode exception.

The instruction’s operation is the same in non-64-bit modes and 64-bit mode.

Operation

MONITOR sets up an address range for the monitor hardware using the content of EAX (RAX in 64-bit mode) as an effective address and puts the monitor hardware in armed state. Always use memory of the write-back caching type. A store to the specified address range will trigger the monitor hardware. The content of ECX and EDX are used to communicate other information to the monitor hardware.

Intel C/C++ Compiler Intrinsic Equivalent

MONITOR `void _mm_monitor(void const *p, unsigned extensions, unsigned hints)`

Numeric Exceptions

None

Protected Mode Exceptions

#GP(0)	If the value in EAX is outside the CS, DS, ES, FS, or GS segment limit. If the DS, ES, FS, or GS register is used to access memory and it contains a NULL segment selector. If ECX \neq 0.
#SS(0)	If the value in EAX is outside the SS segment limit.
#PF(fault-code)	For a page fault.
#UD	If CPUID.01H:ECX.MONITOR[bit 3] = 0. If current privilege level is not 0.

Real Address Mode Exceptions

#GP	If the CS, DS, ES, FS, or GS register is used to access memory and the value in EAX is outside of the effective address space from 0 to FFFFH. If ECX \neq 0.
#SS	If the SS register is used to access memory and the value in EAX is outside of the effective address space from 0 to FFFFH.
#UD	If CPUID.01H:ECX.MONITOR[bit 3] = 0.

Virtual 8086 Mode Exceptions

#UD	The MONITOR instruction is not recognized in virtual-8086 mode (even if CPUID.01H:ECX.MONITOR[bit 3] = 1).
-----	------------------------------------------------------------------------------------------------------------

Compatibility Mode Exceptions

Same exceptions as in protected mode.

64-Bit Mode Exceptions

#GP(0)	If the linear address of the operand in the CS, DS, ES, FS, or GS segment is in a non-canonical form. If RCX \neq 0.
#SS(0)	If the SS register is used to access memory and the value in EAX is in a non-canonical form.
#PF(fault-code)	For a page fault.
#UD	If the current privilege level is not 0. If CPUID.01H: ECX.MONITOR[bit 3] = 0.

MOV—Move

Opcode	Instruction	64-Bit Mode	Compat/Leg Mode	Description
88 /r	MOV r/m8,r8	Valid	Valid	Move r8 to r/m8.
REX + 88 /r	MOV r/m8 ^{***} ,r8 ^{***}	Valid	N.E.	Move r8 to r/m8.
89 /r	MOV r/m16,r16	Valid	Valid	Move r16 to r/m16.
89 /r	MOV r/m32,r32	Valid	Valid	Move r32 to r/m32.
REX.W + 89 /r	MOV r/m64,r64	Valid	N.E.	Move r64 to r/m64.
8A /r	MOV r8,r/m8	Valid	Valid	Move r/m8 to r8.
REX + 8A /r	MOV r8 ^{***} ,r/m8 ^{***}	Valid	N.E.	Move r/m8 to r8.
8B /r	MOV r16,r/m16	Valid	Valid	Move r/m16 to r16.
8B /r	MOV r32,r/m32	Valid	Valid	Move r/m32 to r32.
REX.W + 8B /r	MOV r64,r/m64	Valid	N.E.	Move r/m64 to r64.
8C /r	MOV r/m16,Sreg ^{**}	Valid	Valid	Move segment register to r/m16.
REX.W + 8C /r	MOV r/m64,Sreg ^{**}	Valid	Valid	Move zero extended 16-bit segment register to r/m64.
8E /r	MOV Sreg,r/m16 ^{**}	Valid	Valid	Move r/m16 to segment register.
REX.W + 8E /r	MOV Sreg,r/m64 ^{**}	Valid	Valid	Move lower 16 bits of r/m64 to segment register.
A0	MOV AL,moffs8 [*]	Valid	Valid	Move byte at (seg:offset) to AL.
REX.W + A0	MOV AL,moffs8 [*]	Valid	N.E.	Move byte at (offset) to AL.
A1	MOV AX,moffs16 [*]	Valid	Valid	Move word at (seg:offset) to AX.
A1	MOV EAX,moffs32 [*]	Valid	Valid	Move doubleword at (seg:offset) to EAX.
REX.W + A1	MOV RAX,moffs64 [*]	Valid	N.E.	Move quadword at (offset) to RAX.
A2	MOV moffs8,AL	Valid	Valid	Move AL to (seg:offset).
REX.W + A2	MOV moffs8 ^{***} ,AL	Valid	N.E.	Move AL to (offset).
A3	MOV moffs16 [*] ,AX	Valid	Valid	Move AX to (seg:offset).

A3	MOV <i>moffs32*</i> ,EAX	Valid	Valid	Move EAX to (<i>seg:offset</i>).
Opcode	Instruction	64-Bit Mode	Compat/ Leg Mode	Description
REX.W + A3	MOV <i>moffs64*</i> ,RAX	Valid	N.E.	Move RAX to (<i>offset</i>).
B0+ <i>rb</i>	MOV <i>r8</i> , <i>imm8</i>	Valid	Valid	Move <i>imm8</i> to <i>r8</i> .
REX + B0+ <i>rb</i>	MOV <i>r8***</i> , <i>imm8</i>	Valid	N.E.	Move <i>imm8</i> to <i>r8</i> .
B8+ <i>rw</i>	MOV <i>r16</i> , <i>imm16</i>	Valid	Valid	Move <i>imm16</i> to <i>r16</i> .
B8+ <i>rd</i>	MOV <i>r32</i> , <i>imm32</i>	Valid	Valid	Move <i>imm32</i> to <i>r32</i> .
REX.W + B8+ <i>rd</i>	MOV <i>r64</i> , <i>imm64</i>	Valid	N.E.	Move <i>imm64</i> to <i>r64</i> .
C6 /0	MOV <i>r/m8</i> , <i>imm8</i>	Valid	Valid	Move <i>imm8</i> to <i>r/m8</i> .
REX + C6 /0	MOV <i>r/m8***</i> , <i>imm8</i>	Valid	N.E.	Move <i>imm8</i> to <i>r/m8</i> .
C7 /0	MOV <i>r/m16</i> , <i>imm16</i>	Valid	Valid	Move <i>imm16</i> to <i>r/m16</i> .
C7 /0	MOV <i>r/m32</i> , <i>imm32</i>	Valid	Valid	Move <i>imm32</i> to <i>r/m32</i> .
REX.W + C7 /0	MOV <i>r/m64</i> , <i>imm32</i>	Valid	N.E.	Move <i>imm32 sign</i> extended to 64-bits to <i>r/m64</i> .

NOTES:

- * The *moffs8*, *moffs16*, *moffs32* and *moffs64* operands specify a simple offset relative to the segment base, where 8, 16, 32 and 64 refer to the size of the data. The address-size attribute of the instruction determines the size of the offset, either 16, 32 or 64 bits.
- ** In 32-bit mode, the assembler may insert the 16-bit operand-size prefix with this instruction (see the following “Description” section for further information).
- ***In 64-bit mode, *r/m8* can not be encoded to access the following byte registers if a REX prefix is used: AH, BH, CH, DH.

Description

Copies the second operand (source operand) to the first operand (destination operand). The source operand can be an immediate value, general-purpose register, segment register, or memory location; the destination register can be a general-purpose register, segment register, or memory location. Both operands must be the same size, which can be a byte, a word, a doubleword, or a quadword.

The MOV instruction cannot be used to load the CS register. Attempting to do so results in an invalid opcode exception (#UD). To load the CS register, use the far JMP, CALL, or RET instruction.

If the destination operand is a segment register (DS, ES, FS, GS, or SS), the source operand must be a valid segment selector. In protected mode, moving a segment

selector into a segment register automatically causes the segment descriptor information associated with that segment selector to be loaded into the hidden (shadow) part of the segment register. While loading this information, the segment selector and segment descriptor information is validated (see the “Operation” algorithm below). The segment descriptor data is obtained from the GDT or LDT entry for the specified segment selector.

A NULL segment selector (values 0000-0003) can be loaded into the DS, ES, FS, and GS registers without causing a protection exception. However, any subsequent attempt to reference a segment whose corresponding segment register is loaded with a NULL value causes a general protection exception (#GP) and no memory reference occurs.

Loading the SS register with a MOV instruction inhibits all interrupts until after the execution of the next instruction. This operation allows a stack pointer to be loaded into the ESP register with the next instruction (MOV ESP, **stack-pointer value**) before an interrupt occurs¹. Be aware that the LSS instruction offers a more efficient method of loading the SS and ESP registers.

When operating in 32-bit mode and moving data between a segment register and a general-purpose register, the 32-bit IA-32 processors do not require the use of the 16-bit operand-size prefix (a byte with the value 66H) with this instruction, but most assemblers will insert it if the standard form of the instruction is used (for example, MOV DS, AX). The processor will execute this instruction correctly, but it will usually require an extra clock. With most assemblers, using the instruction form MOV DS, EAX will avoid this unneeded 66H prefix. When the processor executes the instruction with a 32-bit general-purpose register, it assumes that the 16 least-significant bits of the general-purpose register are the destination or source operand. If the register is a destination operand, the resulting value in the two high-order bytes of the register is implementation dependent. For the Pentium 4, Intel Xeon, and P6 family processors, the two high-order bytes are filled with zeros; for earlier 32-bit IA-32 processors, the two high order bytes are undefined.

In 64-bit mode, the instruction’s default operation size is 32 bits. Use of the REX.R prefix permits access to additional registers (R8-R15). Use of the REX.W prefix promotes operation to 64 bits. See the summary chart at the beginning of this section for encoding data and limits.

-
1. If a code instruction breakpoint (for debug) is placed on an instruction located immediately after a MOV SS instruction, the breakpoint may not be triggered. However, in a sequence of instructions that load the SS register, only the first instruction in the sequence is guaranteed to delay an interrupt.

In the following sequence, interrupts may be recognized before MOV ESP, EBP executes:

```
MOV SS, EDX
MOV SS, EAX
MOV ESP, EBP
```

Operation

DEST ← SRC;

Loading a segment register while in protected mode results in special checks and actions, as described in the following listing. These checks are performed on the segment selector and the segment descriptor to which it points.

IF SS is loaded

THEN

IF segment selector is NULL

THEN #GP(0); FI;

IF segment selector index is outside descriptor table limits

or segment selector's RPL ≠ CPL

or segment is not a writable data segment

or DPL ≠ CPL

THEN #GP(selector); FI;

IF segment not marked present

THEN #SS(selector);

ELSE

SS ← segment selector;

SS ← segment descriptor; FI;

FI;

IF DS, ES, FS, or GS is loaded with non-NULL selector

THEN

IF segment selector index is outside descriptor table limits

or segment is not a data or readable code segment

or ((segment is a data or nonconforming code segment)

and (both RPL and CPL > DPL))

THEN #GP(selector); FI;

IF segment not marked present

THEN #NP(selector);

ELSE

SegmentRegister ← segment selector;

SegmentRegister ← segment descriptor; FI;

FI;

IF DS, ES, FS, or GS is loaded with NULL selector

THEN

SegmentRegister ← segment selector;

SegmentRegister ← segment descriptor;

FI;

Flags Affected

None.

Protected Mode Exceptions

#GP(0)	<p>If attempt is made to load SS register with NULL segment selector.</p> <p>If the destination operand is in a non-writable segment.</p> <p>If a memory operand effective address is outside the CS, DS, ES, FS, or GS segment limit.</p> <p>If the DS, ES, FS, or GS register contains a NULL segment selector.</p>
#GP(selector)	<p>If segment selector index is outside descriptor table limits.</p> <p>If the SS register is being loaded and the segment selector's RPL and the segment descriptor's DPL are not equal to the CPL.</p> <p>If the SS register is being loaded and the segment pointed to is a non-writable data segment.</p> <p>If the DS, ES, FS, or GS register is being loaded and the segment pointed to is not a data or readable code segment.</p> <p>If the DS, ES, FS, or GS register is being loaded and the segment pointed to is a data or nonconforming code segment, but both the RPL and the CPL are greater than the DPL.</p>
#SS(0)	<p>If a memory operand effective address is outside the SS segment limit.</p>
#SS(selector)	<p>If the SS register is being loaded and the segment pointed to is marked not present.</p>
#NP	<p>If the DS, ES, FS, or GS register is being loaded and the segment pointed to is marked not present.</p>
#PF(fault-code)	<p>If a page fault occurs.</p>
#AC(0)	<p>If alignment checking is enabled and an unaligned memory reference is made while the current privilege level is 3.</p>
#UD	<p>If attempt is made to load the CS register.</p> <p>If the LOCK prefix is used.</p>

Real-Address Mode Exceptions

#GP	<p>If a memory operand effective address is outside the CS, DS, ES, FS, or GS segment limit.</p>
#SS	<p>If a memory operand effective address is outside the SS segment limit.</p>
#UD	<p>If attempt is made to load the CS register.</p> <p>If the LOCK prefix is used.</p>

Virtual-8086 Mode Exceptions

#GP(0)	If a memory operand effective address is outside the CS, DS, ES, FS, or GS segment limit.
#SS(0)	If a memory operand effective address is outside the SS segment limit.
#PF(fault-code)	If a page fault occurs.
#AC(0)	If alignment checking is enabled and an unaligned memory reference is made.
#UD	If attempt is made to load the CS register. If the LOCK prefix is used.

Compatibility Mode Exceptions

Same exceptions as in protected mode.

64-Bit Mode Exceptions

#GP(0)	If the memory address is in a non-canonical form. If an attempt is made to load SS register with NULL segment selector when CPL = 3. If an attempt is made to load SS register with NULL segment selector when CPL < 3 and CPL ≠ RPL.
#GP(selector)	If segment selector index is outside descriptor table limits. If the memory access to the descriptor table is non-canonical. If the SS register is being loaded and the segment selector's RPL and the segment descriptor's DPL are not equal to the CPL. If the SS register is being loaded and the segment pointed to is a nonwritable data segment. If the DS, ES, FS, or GS register is being loaded and the segment pointed to is not a data or readable code segment. If the DS, ES, FS, or GS register is being loaded and the segment pointed to is a data or nonconforming code segment, but both the RPL and the CPL are greater than the DPL.
#SS(0)	If the stack address is in a non-canonical form.
#SS(selector)	If the SS register is being loaded and the segment pointed to is marked not present.
#PF(fault-code)	If a page fault occurs.
#AC(0)	If alignment checking is enabled and an unaligned memory reference is made while the current privilege level is 3.
#UD	If attempt is made to load the CS register. If the LOCK prefix is used.

MOV—Move to/from Control Registers

Opcode	Instruction	64-Bit Mode	Compat/Leg Mode	Description
OF 20/ <i>r</i>	MOV <i>r32</i> , CR0–CR7	N.E.	Valid	Move control register to <i>r32</i>
OF 20/ <i>r</i>	MOV <i>r64</i> , CR0–CR7	Valid	N.E.	Move extended control register to <i>r64</i> .
REX.R + OF 20 /0	MOV <i>r64</i> , CR8	Valid	N.E.	Move extended CR8 to <i>r64</i> . ¹
OF 22 / <i>r</i>	MOV CR0–CR7, <i>r32</i>	N.E.	Valid	Move <i>r32</i> to control register
OF 22 / <i>r</i>	MOV CR0–CR7, <i>r64</i>	Valid	N.E.	Move <i>r64</i> to extended control register.
REX.R + OF 22 /0	MOV CR8, <i>r64</i>	Valid	N.E.	Move <i>r64</i> to extended CR8. ¹

NOTE:

1. MOV CR* instructions, except for MOV CR8, are serializing instructions. MOV CR8 is not architecturally defined as a serializing instruction. For more information, see Chapter 8 in *Intel® 64 and IA-32 Architectures Software Developer's Manual, Volume 3A*.

Description

Moves the contents of a control register (CR0, CR2, CR3, CR4, or CR8) to a general-purpose register or the contents of a general purpose register to a control register. The operand size for these instructions is always 32 bits in non-64-bit modes, regardless of the operand-size attribute. (See “Control Registers” in Chapter 2 of the *Intel® 64 and IA-32 Architectures Software Developer's Manual, Volume 3A*, for a detailed description of the flags and fields in the control registers.) This instruction can be executed only when the current privilege level is 0.

At the opcode level, the *reg* field within the ModR/M byte specifies which of the control registers is loaded or read. The 2 bits in the *mod* field are ignored. The *r/m* field specifies the general-purpose register loaded or read. Attempts to reference CR1, CR5, CR6, CR7, and CR9–CR15 result in undefined opcode (#UD) exceptions.

When loading control registers, programs should not attempt to change the reserved bits; that is, always set reserved bits to the value previously read. An attempt to change CR4's reserved bits will cause a general protection fault. Reserved bits in CR0 and CR3 remain clear after any load of those registers; attempts to set them have no impact. On Pentium 4, Intel Xeon and P6 family processors, CR0.ET remains set after any load of CR0; attempts to clear this bit have no impact.

These instructions have the following side effect:

- When writing to control register CR3, all non-global TLB entries are flushed (see “Caching Translation Information” in Chapter 4 of the *Intel® 64 and IA-32 Architectures Software Developer's Manual, Volume 3A*).

The following side effects are implementation specific for the Pentium 4, Intel Xeon, and P6 processor family. Software should not depend on this functionality in all Intel 64 or IA-32 processors:

- When modifying any of the paging flags in the control registers (PE and PG in register CR0 and PGE, PSE, and PAE in register CR4), all TLB entries are flushed, including global entries.
- If the PG flag is set to 1 and control register CR4 is written to set the PAE flag to 1 (to enable the physical address extension mode), the pointers in the page-directory pointers table (PDPT) are loaded into the processor (into internal, non-architectural registers).
- If the PAE flag is set to 1 and the PG flag set to 1, writing to control register CR3 will cause the PDPTs to be reloaded into the processor. If the PAE flag is set to 1 and control register CR0 is written to set the PG flag, the PDPTs are reloaded into the processor.

In 64-bit mode, the instruction's default operation size is 64 bits. The REX.R prefix must be used to access CR8. Use of REX.B permits access to additional registers (R8-R15). Use of the REX.W prefix or 66H prefix is ignored. Use of the REX.R prefix to specify a register other than CR8 causes an invalid-opcode exception. See the summary chart at the beginning of this section for encoding data and limits.

See "Changes to Instruction Behavior in VMX Non-Root Operation" in Chapter 22 of the *Intel® 64 and IA-32 Architectures Software Developer's Manual, Volume 3B*, for more information about the behavior of this instruction in VMX non-root operation.

Operation

DEST ← SRC;

Flags Affected

The OF, SF, ZF, AF, PF, and CF flags are undefined.

Protected Mode Exceptions

#GP(0)	<p>If the current privilege level is not 0.</p> <p>If an attempt is made to write invalid bit combinations in CR0 (such as setting the PG flag to 1 when the PE flag is set to 0, or setting the CD flag to 0 when the NW flag is set to 1).</p> <p>If an attempt is made to write a 1 to any reserved bit in CR4.</p> <p>If any of the reserved bits are set in the page-directory pointers table (PDPT) and the loading of a control register causes the PDPT to be loaded into the processor.</p>
#UD	<p>If the LOCK prefix is used.</p> <p>If an attempt is made to access CR1, CR5, CR6, or CR7.</p>

Real-Address Mode Exceptions

- #GP If an attempt is made to write a 1 to any reserved bit in CR4.
 If an attempt is made to write invalid bit combinations in CR0
 (such as setting the PG flag to 1 when the PE flag is set to 0).
- #UD If the LOCK prefix is used.
 If an attempt is made to access CR1, CR5, CR6, or CR7.

Virtual-8086 Mode Exceptions

- #GP(0) These instructions cannot be executed in virtual-8086 mode.

Compatibility Mode Exceptions

- #GP(0) If the current privilege level is not 0.
 If an attempt is made to write invalid bit combinations in CR0
 (such as setting the PG flag to 1 when the PE flag is set to 0, or
 setting the CD flag to 0 when the NW flag is set to 1).
 If an attempt is made to write a 1 to any reserved bit in CR3.
 If an attempt is made to leave IA-32e mode by clearing
 CR4.PAE[bit 5].
- #UD If the LOCK prefix is used.
 If an attempt is made to access CR1, CR5, CR6, or CR7.

64-Bit Mode Exceptions

- #GP(0) If the current privilege level is not 0.
 If an attempt is made to write invalid bit combinations in CR0
 (such as setting the PG flag to 1 when the PE flag is set to 0, or
 setting the CD flag to 0 when the NW flag is set to 1).
 Attempting to clear CR0.PG[bit 31].
 If an attempt is made to write a 1 to any reserved bit in CR4.
 If an attempt is made to write a 1 to any reserved bit in CR8.
 If an attempt is made to write a 1 to any reserved bit in CR3.
 If an attempt is made to leave IA-32e mode by clearing
 CR4.PAE[bit 5].
- #UD If the LOCK prefix is used.
 If an attempt is made to access CR1, CR5, CR6, or CR7.
 If the REX.R prefix is used to specify a register other than CR8.

MOV—Move to/from Debug Registers

Opcode	Instruction	64-Bit Mode	Compat/Leg Mode	Description
OF 21/ <i>r</i>	MOV <i>r32</i> , DR0-DR7	N.E.	Valid	Move debug register to <i>r32</i>
OF 21/ <i>r</i>	MOV <i>r64</i> , DR0-DR7	Valid	N.E.	Move extended debug register to <i>r64</i> .
OF 23 / <i>r</i>	MOV DR0-DR7, <i>r32</i>	N.E.	Valid	Move <i>r32</i> to debug register
OF 23 / <i>r</i>	MOV DR0-DR7, <i>r64</i>	Valid	N.E.	Move <i>r64</i> to extended debug register.

Description

Moves the contents of a debug register (DR0, DR1, DR2, DR3, DR4, DR5, DR6, or DR7) to a general-purpose register or vice versa. The operand size for these instructions is always 32 bits in non-64-bit modes, regardless of the operand-size attribute. (See Chapter 19, “Debugging and Performance Monitoring”, of the *Intel® 64 and IA-32 Architectures Software Developer’s Manual, Volume 3A*, for a detailed description of the flags and fields in the debug registers.)

The instructions must be executed at privilege level 0 or in real-address mode.

When the debug extension (DE) flag in register CR4 is clear, these instructions operate on debug registers in a manner that is compatible with Intel386 and Intel486 processors. In this mode, references to DR4 and DR5 refer to DR6 and DR7, respectively. When the DE flag in CR4 is set, attempts to reference DR4 and DR5 result in an undefined opcode (#UD) exception. (The CR4 register was added to the IA-32 Architecture beginning with the Pentium processor.)

At the opcode level, the *reg* field within the ModR/M byte specifies which of the debug registers is loaded or read. The two bits in the *mod* field are ignored. The *r/m* field specifies the general-purpose register loaded or read.

In 64-bit mode, the instruction’s default operation size is 64 bits. Use of the REX.B prefix permits access to additional registers (R8–R15). Use of the REX.W or 66H prefix is ignored. Use of the REX.R prefix causes an invalid-opcode exception. See the summary chart at the beginning of this section for encoding data and limits.

Operation

```
IF ((DE = 1) and (SRC or DEST = DR4 or DR5))
    THEN
        #UD;
    ELSE
        DEST ← SRC;
FI;
```

Flags Affected

The OF, SF, ZF, AF, PF, and CF flags are undefined.

Protected Mode Exceptions

#GP(0)	If the current privilege level is not 0.
#UD	If CR4.DE[bit 3] = 1 (debug extensions) and a MOV instruction is executed involving DR4 or DR5. If the LOCK prefix is used.
#DB	If any debug register is accessed while the DR7.GD[bit 13] = 1.

Real-Address Mode Exceptions

#UD	If CR4.DE[bit 3] = 1 (debug extensions) and a MOV instruction is executed involving DR4 or DR5. If the LOCK prefix is used.
#DB	If any debug register is accessed while the DR7.GD[bit 13] = 1.

Virtual-8086 Mode Exceptions

#GP(0)	The debug registers cannot be loaded or read when in virtual-8086 mode.
--------	-------------------------------------------------------------------------

Compatibility Mode Exceptions

Same exceptions as in protected mode.

64-Bit Mode Exceptions

#GP(0)	If the current privilege level is not 0.
#UD	If CR4.DE[bit 3] = 1 (debug extensions) and a MOV instruction is executed involving DR4 or DR5. If the LOCK prefix is used. If the REX.R prefix is used.
#DB	If any debug register is accessed while the DR7.GD[bit 13] = 1.

MOVAPD—Move Aligned Packed Double-Precision Floating-Point Values

Opcode	Instruction	64-Bit Mode	Compat/ Leg Mode	Description
66 0F 28 /r	MOVAPD <i>xmm1</i> , <i>xmm2/m128</i>	Valid	Valid	Move packed double-precision floating-point values from <i>xmm2/m128</i> to <i>xmm1</i> .
66 0F 29 /r	MOVAPD <i>xmm2/m128, xmm1</i>	Valid	Valid	Move packed double-precision floating-point values from <i>xmm1</i> to <i>xmm2/m128</i> .

Description

Moves a double quadword containing two packed double-precision floating-point values from the source operand (second operand) to the destination operand (first operand). This instruction can be used to load an XMM register from a 128-bit memory location, to store the contents of an XMM register into a 128-bit memory location, or to move data between two XMM registers. When the source operand is a memory operand, the operand must be aligned on a 16-byte boundary or a general-protection exception (#GP) will be generated.

To move double-precision floating-point values to and from unaligned memory locations, use the MOVUPD instruction.

In 64-bit mode, use of the REX.R prefix permits this instruction to access additional registers (XMM8-XMM15).

Operation

DEST ← SRC;

(* #GP if SRC or DEST unaligned memory operand *)

Intel C/C++ Compiler Intrinsic Equivalent

```
__m128 _mm_load_pd(double * p)
```

```
void _mm_store_pd(double *p, __m128 a)
```

SIMD Floating-Point Exceptions

None.

Protected Mode Exceptions

#GP(0)	For an illegal memory operand effective address in the CS, DS, ES, FS or GS segments. If a memory operand is not aligned on a 16-byte boundary, regardless of segment.
#SS(0)	For an illegal address in the SS segment.
#PF(fault-code)	For a page fault.
#NM	If CR0.TS[bit 3] = 1.
#UD	If CR0.EM[bit 2] = 1. If CR4.OSFXSR[bit 9] = 0. If CPUID.01H:EDX.SSE2[bit 26] = 0. If the LOCK prefix is used.

Real-Address Mode Exceptions

#GP	If a memory operand is not aligned on a 16-byte boundary, regardless of segment. If any part of the operand lies outside the effective address space from 0 to FFFFH.
#NM	If CR0.TS[bit 3] = 1.
#UD	If CR0.EM[bit 2] = 1. If CR4.OSFXSR[bit 9] = 0. If CPUID.01H:EDX.SSE2[bit 26] = 0. If the LOCK prefix is used.

Virtual-8086 Mode Exceptions

Same exceptions as in real address mode.

#PF(fault-code)	For a page fault.
-----------------	-------------------

Compatibility Mode Exceptions

Same exceptions as in protected mode.

64-Bit Mode Exceptions

#SS(0)	If a memory address referencing the SS segment is in a non-canonical form.
#GP(0)	If the memory address is in a non-canonical form. If memory operand is not aligned on a 16-byte boundary, regardless of segment.
#PF(fault-code)	For a page fault.
#NM	If CR0.TS[bit 3] = 1.

#UD

If CR0.EM[bit 2] = 1.

If CR4.OSFXSR[bit 9] = 0.

If CPUID.01H:EDX.SSE2[bit 26] = 0.

If the LOCK prefix is used.

MOVAPS—Move Aligned Packed Single-Precision Floating-Point Values

Opcode	Instruction	64-Bit Mode	Compat/ Leg Mode	Description
0F 28 /r	MOVAPS <i>xmm1</i> , <i>xmm2/m128</i>	Valid	Valid	Move packed single-precision floating-point values from <i>xmm2/m128</i> to <i>xmm1</i> .
0F 29 /r	MOVAPS <i>xmm2/m128</i> , <i>xmm1</i>	Valid	Valid	Move packed single-precision floating-point values from <i>xmm1</i> to <i>xmm2/m128</i> .

Description

Moves a double quadword containing four packed single-precision floating-point values from the source operand (second operand) to the destination operand (first operand). This instruction can be used to load an XMM register from a 128-bit memory location, to store the contents of an XMM register into a 128-bit memory location, or to move data between two XMM registers. When the source or destination operand is a memory operand, the operand must be aligned on a 16-byte boundary or a general-protection exception (#GP) is generated.

To move packed single-precision floating-point values to or from unaligned memory locations, use the MOVUPS instruction.

In 64-bit mode, use of the REX.R prefix permits this instruction to access additional registers (XMM8-XMM15).

Operation

DEST ← SRC;

(* #GP if SRC or DEST unaligned memory operand *)

Intel C/C++ Compiler Intrinsic Equivalent

`__m128 _mm_load_ps (float * p)`

`void _mm_store_ps (float *p, __m128 a)`

SIMD Floating-Point Exceptions

None.

Protected Mode Exceptions

#GP(0)	For an illegal memory operand effective address in the CS, DS, ES, FS or GS segments. If a memory operand is not aligned on a 16-byte boundary, regardless of segment.
#SS(0)	For an illegal address in the SS segment.
#PF(fault-code)	For a page fault.
#NM	If CR0.TS[bit 3] = 1.
#UD	If CR0.EM[bit 2] = 1. If CR4.OSFXSR[bit 9] = 0. If CPUID.01H: EDX.SSE[bit 25] = 0. If the LOCK prefix is used.

Real-Address Mode Exceptions

#GP	If a memory operand is not aligned on a 16-byte boundary, regardless of segment. If any part of the operand lies outside the effective address space from 0 to FFFFH.
#NM	If CR0.TS[bit 3] = 1.
#UD	If CR0.EM[bit 2] = 1. If CR4.OSFXSR[bit 9] = 0. If CPUID.01H: EDX.SSE[bit 25] = 0. If the LOCK prefix is used.

Virtual-8086 Mode Exceptions

Same exceptions as in real address mode.

#PF(fault-code)	For a page fault.
-----------------	-------------------

Compatibility Mode Exceptions

Same exceptions as in protected mode.

64-Bit Mode Exceptions

#SS(0)	If a memory address referencing the SS segment is in a non-canonical form.
#GP(0)	If the memory address is in a non-canonical form. If memory operand is not aligned on a 16-byte boundary, regardless of segment.
#PF(fault-code)	For a page fault.
#NM	If CR0.TS[bit 3] = 1.

#UD

If CR0.EM[bit 2] = 1.

If CR4.OSFXSR[bit 9] = 0.

If CPUID.01H: EDX.SSE[bit 25] = 0.

If the LOCK prefix is used.

MOVBE—Move Data After Swapping Bytes

Opcode	Instruction	64-Bit Mode	Compat/Leg Mode	Description
OF 38 F0 /r	MOVBE r16, m16	Valid	Valid	Reverse byte order in m16 and move to r16
OF 38 F0 /r	MOVBE r32, m32	Valid	Valid	Reverse byte order in m32 and move to r32
REX.W + OF 38 F0 /r	MOVBE r64, m64	Valid	N.E.	Reverse byte order in m64 and move to r64.
OF 38 F1 /r	MOVBE m16, r16	Valid	Valid	Reverse byte order in r16 and move to m16
OF 38 F1 /r	MOVBE m32, r32	Valid	Valid	Reverse byte order in r32 and move to m32
REX.W + OF 38 F1 /r	MOVBE m64, r64	Valid	N.E.	Reverse byte order in r64 and move to m64.

Description

Performs a byte swap operation on the data copied from the second operand (source operand) and store the result in the first operand (destination operand). The source operand can be a general-purpose register, or memory location; the destination register can be a general-purpose register, or a memory location; however, both operands can not be registers, and only one operand can be a memory location. Both operands must be the same size, which can be a word, a doubleword or quadword.

The MOVBE instruction is provided for swapping the bytes on a read from memory or on a write to memory; thus providing support for converting little-endian values to big-endian format and vice versa.

In 64-bit mode, the instruction's default operation size is 32 bits. Use of the REX.R prefix permits access to additional registers (R8-R15). Use of the REX.W prefix promotes operation to 64 bits. See the summary chart at the beginning of this section for encoding data and limits.

Operation

TEMP ← SRC

IF (OperandSize = 16)

THEN

DEST[7:0] ← TEMP[15:8];

DEST[15:8] ← TEMP[7:0];

ELES IF (OperandSize = 32)

DEST[7:0] ← TEMP[31:24];

```

DEST[15:8] ← TEMP[23:16];
DEST[23:16] ← TEMP[15:8];
DEST[31:23] ← TEMP[7:0];
ELSE IF ( OperandSize = 64)
DEST[7:0] ← TEMP[63:56];
DEST[15:8] ← TEMP[55:48];
DEST[23:16] ← TEMP[47:40];
DEST[31:24] ← TEMP[39:32];
DEST[39:32] ← TEMP[31:24];
DEST[47:40] ← TEMP[23:16];
DEST[55:48] ← TEMP[15:8];
DEST[63:56] ← TEMP[7:0];

```

FI;

Flags Affected

None.

Protected Mode Exceptions

#GP(0)	<p>If the destination operand is in a non-writable segment.</p> <p>If a memory operand effective address is outside the CS, DS, ES, FS, or GS segment limit.</p> <p>If the DS, ES, FS, or GS register contains a NULL segment selector.</p>
#SS(0)	<p>If a memory operand effective address is outside the SS segment limit.</p>
#PF(fault-code)	<p>If a page fault occurs.</p>
#AC(0)	<p>If alignment checking is enabled and an unaligned memory reference is made while the current privilege level is 3.</p>
#UD	<p>If CPUID.01H: ECX.MOVBE[bit 22] = 0 .</p> <p>If the LOCK prefix is used.</p> <p>If REP (F3H) prefix is used.</p>

Real-Address Mode Exceptions

#GP	<p>If a memory operand effective address is outside the CS, DS, ES, FS, or GS segment limit.</p>
#SS	<p>If a memory operand effective address is outside the SS segment limit.</p>
#UD	<p>If CPUID.01H: ECX.MOVBE[bit 22] = 0 .</p> <p>If the LOCK prefix is used.</p> <p>If REP (F3H) prefix is used.</p>

Virtual-8086 Mode Exceptions

#GP(0)	If a memory operand effective address is outside the CS, DS, ES, FS, or GS segment limit.
#SS(0)	If a memory operand effective address is outside the SS segment limit.
#PF(fault-code)	If a page fault occurs.
#UD	If CPUID.01H: ECX.MOVBE[bit 22] = 0 . If the LOCK prefix is used. If REP (F3H) prefix is used. If REPNE (F2H) prefix is used and CPUID.01H: ECX.SSE4_2[bit 20] = 0.

Compatibility Mode Exceptions

Same exceptions as in protected mode.

64-Bit Mode Exceptions

#GP(0)	If the memory address is in a non-canonical form.
#SS(0)	If the stack address is in a non-canonical form.
#PF(fault-code)	If a page fault occurs.
#AC(0)	If alignment checking is enabled and an unaligned memory reference is made while the current privilege level is 3.
#UD	If CPUID.01H: ECX.MOVBE[bit 22] = 0 . If the LOCK prefix is used. If REP (F3H) prefix is used.

MOVD/MOVQ—Move Doubleword/Move Quadword

Opcode	Instruction	64-Bit Mode	Compat/ Leg Mode	Description
0F 6E /r	MOVD <i>mm, r/m32</i>	Valid	Valid	Move doubleword from <i>r/m32</i> to <i>mm</i> .
REX.W + 0F 6E /r	MOVQ <i>mm, r/m64</i>	Valid	N.E.	Move quadword from <i>r/m64</i> to <i>mm</i> .
0F 7E /r	MOVD <i>r/m32, mm</i>	Valid	Valid	Move doubleword from <i>mm</i> to <i>r/m32</i> .
REX.W + 0F 7E /r	MOVQ <i>r/m64, mm</i>	Valid	N.E.	Move quadword from <i>mm</i> to <i>r/m64</i> .
66 0F 6E /r	MOVD <i>xmm, r/m32</i>	Valid	Valid	Move doubleword from <i>r/m32</i> to <i>xmm</i> .
66 REX.W 0F 6E /r	MOVQ <i>xmm, r/m64</i>	Valid	N.E.	Move quadword from <i>r/m64</i> to <i>xmm</i> .
66 0F 7E /r	MOVD <i>r/m32, xmm</i>	Valid	Valid	Move doubleword from <i>xmm</i> register to <i>r/m32</i> .
66 REX.W 0F 7E /r	MOVQ <i>r/m64, xmm</i>	Valid	N.E.	Move quadword from <i>xmm</i> register to <i>r/m64</i> .

Description

Copies a doubleword from the source operand (second operand) to the destination operand (first operand). The source and destination operands can be general-purpose registers, MMX technology registers, XMM registers, or 32-bit memory locations. This instruction can be used to move a doubleword to and from the low doubleword of an MMX technology register and a general-purpose register or a 32-bit memory location, or to and from the low doubleword of an XMM register and a general-purpose register or a 32-bit memory location. The instruction cannot be used to transfer data between MMX technology registers, between XMM registers, between general-purpose registers, or between memory locations.

When the destination operand is an MMX technology register, the source operand is written to the low doubleword of the register, and the register is zero-extended to 64 bits. When the destination operand is an XMM register, the source operand is written to the low doubleword of the register, and the register is zero-extended to 128 bits.

In 64-bit mode, the instruction's default operation size is 32 bits. Use of the REX.R prefix permits access to additional registers (R8-R15). Use of the REX.W prefix promotes operation to 64 bits. See the summary chart at the beginning of this section for encoding data and limits.

Operation

MOVD instruction when destination operand is MMX technology register:

```
DEST[31:0] ← SRC;
DEST[63:32] ← 00000000H;
```

MOVD instruction when destination operand is XMM register:

```
DEST[31:0] ← SRC;
DEST[127:32] ← 000000000000000000000000H;
```

MOVD instruction when source operand is MMX technology or XMM register:

```
DEST ← SRC[31:0];
```

MOVQ instruction when destination operand is XMM register:

```
DEST[63:0] ← SRC[63:0];
DEST[127:64] ← 000000000000000000H;
```

MOVQ instruction when destination operand is r/m64:

```
DEST[63:0] ← SRC[63:0];
```

MOVQ instruction when source operand is XMM register or r/m64:

```
DEST ← SRC[63:0];
```

Intel C/C++ Compiler Intrinsic Equivalent

```
MOVD    __m64 _mm_cvtsi32_si64 (int i)
MOVD    int _mm_cvtsi64_si32 ( __m64m)
MOVD    __m128i _mm_cvtsi32_si128 (int a)
MOVD    int _mm_cvtsi128_si32 ( __m128i a)
```

Flags Affected

None.

SIMD Floating-Point Exceptions

None.

Protected Mode Exceptions

#GP(0)	If the destination operand is in a non-writable segment. If a memory operand effective address is outside the CS, DS, ES, FS, or GS segment limit.
#SS(0)	If a memory operand effective address is outside the SS segment limit.

#UD	If CR0.EM[bit 2] = 1. 128-bit operations will generate #UD only if CR4.OSFXSR[bit 9] = 0. Execution of 128-bit instructions on a non-SSE2 capable processor (one that is MMX technology capable) will result in the instruction operating on the mm registers, not #UD. If the LOCK prefix is used.
#NM	If CR0.TS[bit 3] = 1.
#MF	(MMX register operations only) If there is a pending FPU exception.
#PF(fault-code)	If a page fault occurs.
#AC(0)	If alignment checking is enabled and an unaligned memory reference is made while the current privilege level is 3.

Real-Address Mode Exceptions

#GP	If any part of the operand lies outside of the effective address space from 0 to FFFFH.
#UD	If CR0.EM[bit 2] = 1. 128-bit operations will generate #UD only if CR4.OSFXSR[bit 9] = 0. Execution of 128-bit instructions on a non-SSE2 capable processor (one that is MMX technology capable) will result in the instruction operating on the mm registers, not #UD. If the LOCK prefix is used.
#NM	If CR0.TS[bit 3] = 1.
#MF	(MMX register operations only) If there is a pending FPU exception.

Virtual-8086 Mode Exceptions

Same exceptions as in real address mode.

#PF(fault-code)	If a page fault occurs.
#AC(0)	If alignment checking is enabled and an unaligned memory reference is made.

Compatibility Mode Exceptions

Same exceptions as in protected mode.

64-Bit Mode Exceptions

#SS(0)	If a memory address referencing the SS segment is in a non-canonical form.
#GP(0)	If the memory address is in a non-canonical form.

#UD	If CR0.EM[bit 2] = 1. (XMM register operations only) if CR4.OSFXSR[bit 9] = 0. (XMM register operations only) if CPUID.01H:EDX.SSE2[bit 26] = 0. If the LOCK prefix is used.
#NM	If CR0.TS[bit 3] = 1.
#MF	(MMX register operations only) If there is a pending FPU exception.
#PF(fault-code)	If a page fault occurs.
#AC(0)	If alignment checking is enabled and an unaligned memory reference is made while the current privilege level is 3.

MOVDDUP—Move One Double-FP and Duplicate

Opcode	Instruction	64-Bit Mode	Compat/ Leg Mode	Description
F2 0F 12 /r	MOVDDUP <i>xmm1</i> , <i>xmm2/m64</i>	Valid	Valid	Move one double-precision floating-point value from the lower 64-bit operand in <i>xmm2/m64</i> to <i>xmm1</i> and duplicate.

Description

The linear address corresponds to the address of the least-significant byte of the referenced memory data. When a memory address is indicated, the 8 bytes of data at memory location *m64* are loaded. When the register-register form of this operation is used, the lower half of the 128-bit source register is duplicated and copied into the 128-bit destination register. See Figure 3-15.

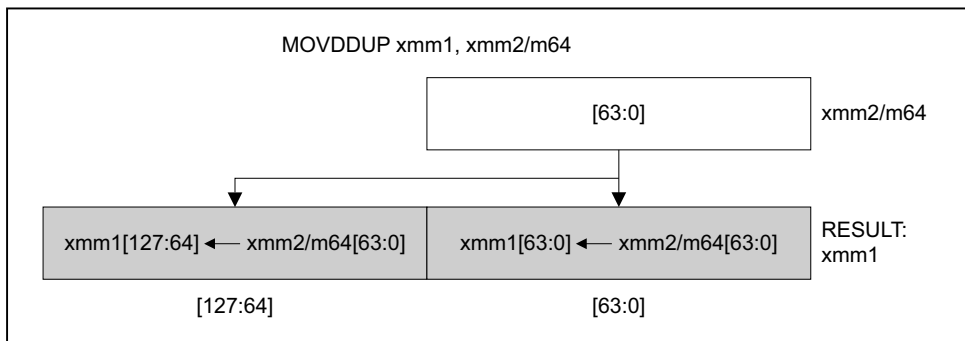

OM15997

Figure 3-15. MOVDDUP—Move One Double-FP and Duplicate

In 64-bit mode, use of the REX.R prefix permits this instruction to access additional registers (XMM8-XMM15).

Operation

IF (Source == *m64*)

THEN

(* Load instruction *)

xmm1[63:0] = *m64*;

```

    xmm1[127:64] = m64;
ELSE
    (* Move instruction *)
    xmm1[63:0] = xmm2[63:0];
    xmm1[127:64] = xmm2[63:0];
FI;

```

Intel C/C++ Compiler Intrinsic Equivalent

```

MOVDDUP    __m128d _mm_movedup_pd(__m128d a)
           __m128d _mm_loaddup_pd(double const * dp)

```

Exceptions

None

Numeric Exceptions

None

Protected Mode Exceptions

#GP(0)	For an illegal memory operand effective address in the CS, DS, ES, FS or GS segments.
#SS(0)	For an illegal address in the SS segment.
#PF(fault-code)	For a page fault.
#NM	If CR0.TS[bit 3] = 1.
#UD	If CR0.EM[bit 2] = 1. If CR4.OSFXSR[bit 9] = 0. If CPUID.01H: ECX.SSE3[bit 0] = 0. If the LOCK prefix is used.
#AC(0)	If alignment checking is enabled and an unaligned memory reference is made while the current privilege level is 3.

Real Address Mode Exceptions

GP(0)	If any part of the operand would lie outside of the effective address space from 0 to OFFFHH.
#NM	If CR0.TS[bit 3] = 1.
#UD	If CR0.EM[bit 2] = 1. If CR4.OSFXSR[bit 9] = 0. If CPUID.01H: ECX.SSE3[bit 0] = 0. If the LOCK prefix is used.

Virtual 8086 Mode Exceptions

GP(0)	If any part of the operand would lie outside of the effective address space from 0 to 0FFFFH.
#NM	If CR0.TS[bit 3] = 1.
#UD	If CR0.EM[bit 2] = 1. If CR4.OSFXSR[bit 9] = 0. If CPUID.01H: ECX.SSE3[bit 0] = 0. If the LOCK prefix is used.
#PF(fault-code)	For a page fault.
#AC(0)	If alignment checking is enabled and an unaligned memory reference is made.

Compatibility Mode Exceptions

Same exceptions as in protected mode.

64-Bit Mode Exceptions

#SS(0)	If a memory address referencing the SS segment is in a non-canonical form.
#GP(0)	If the memory address is in a non-canonical form.
#PF(fault-code)	For a page fault.
#NM	If CR0.TS[bit 3] = 1.
#UD	If CR0.EM[bit 2] = 1. If CR4.OSFXSR[bit 9] = 0. If CPUID.SSE3(ECX, bit 0) is 0. If the LOCK prefix is used.
#AC(0)	If alignment checking is enabled and an unaligned memory reference is made while the current privilege level is 3.

MOVDQA—Move Aligned Double Quadword

Opcode	Instruction	64-Bit Mode	Compat/ Leg Mode	Description
66 0F 6F /r	MOVDQA <i>xmm1</i> , <i>xmm2/m128</i>	Valid	Valid	Move aligned double quadword from <i>xmm2/m128</i> to <i>xmm1</i> .
66 0F 7F /r	MOVDQA <i>xmm2/m128</i> , <i>xmm1</i>	Valid	Valid	Move aligned double quadword from <i>xmm1</i> to <i>xmm2/m128</i> .

Description

Moves a double quadword from the source operand (second operand) to the destination operand (first operand). This instruction can be used to load an XMM register from a 128-bit memory location, to store the contents of an XMM register into a 128-bit memory location, or to move data between two XMM registers. When the source or destination operand is a memory operand, the operand must be aligned on a 16-byte boundary or a general-protection exception (#GP) will be generated.

To move a double quadword to or from unaligned memory locations, use the MOVDQU instruction.

In 64-bit mode, use of the REX.R prefix permits this instruction to access additional registers (XMM8-XMM15).

Operation

DEST ← SRC;
(* #GP if SRC or DEST unaligned memory operand *)

Intel C/C++ Compiler Intrinsic Equivalent

MOVDQA `__m128i_mm_load_si128 (__m128i *p)`

MOVDQA `void_mm_store_si128 (__m128i *p, __m128i a)`

SIMD Floating-Point Exceptions

None.

Protected Mode Exceptions

- #PF(fault-code) If a page fault occurs.
- #GP(0) If a memory operand effective address is outside the CS, DS, ES, FS, or GS segment limit.
If a memory operand is not aligned on a 16-byte boundary, regardless of segment.

#SS(0)	If a memory operand effective address is outside the SS segment limit.
#NM	If CR0.TS[bit 3] = 1.
#UD	If CR0.EM[bit 2] = 1. If CR4.OSFXSR[bit 9] = 0. If CPUID.01H:EDX.SSE2[bit 26] = 0. If the LOCK prefix is used.

Real-Address Mode Exceptions

#GP	If a memory operand is not aligned on a 16-byte boundary, regardless of segment. If any part of the operand lies outside of the effective address space from 0 to FFFFH.
#NM	If CR0.TS[bit 3] = 1.
#UD	If CR0.EM[bit 2] = 1. If CR4.OSFXSR[bit 9] = 0. If CPUID.01H:EDX.SSE2[bit 26] = 0. If the LOCK prefix is used.

Virtual-8086 Mode Exceptions

Same exceptions as in real address mode.

#PF(fault-code)	For a page fault.
-----------------	-------------------

Compatibility Mode Exceptions

Same exceptions as in protected mode.

64-Bit Mode Exceptions

#SS(0)	If a memory address referencing the SS segment is in a non-canonical form.
#GP(0)	If the memory address is in a non-canonical form. If memory operand is not aligned on a 16-byte boundary, regardless of segment.
#PF(fault-code)	For a page fault.
#NM	If CR0.TS[bit 3] = 1.
#UD	If CR0.EM[bit 2] = 1. If CR4.OSFXSR[bit 9] = 0. If CPUID.01H:EDX.SSE2[bit 26] = 0. If the LOCK prefix is used.

MOVDQU—Move Unaligned Double Quadword

Opcode	Instruction	64-Bit Mode	Compat/ Leg Mode	Description
F3 0F 6F /r	MOVDQU <i>xmm1</i> , <i>xmm2/m128</i>	Valid	Valid	Move unaligned double quadword from <i>xmm2/m128</i> to <i>xmm1</i> .
F3 0F 7F /r	MOVDQU <i>xmm2/m128</i> , <i>xmm1</i>	Valid	Valid	Move unaligned double quadword from <i>xmm1</i> to <i>xmm2/m128</i> .

Description

Moves a double quadword from the source operand (second operand) to the destination operand (first operand). This instruction can be used to load an XMM register from a 128-bit memory location, to store the contents of an XMM register into a 128-bit memory location, or to move data between two XMM registers. When the source or destination operand is a memory operand, the operand may be unaligned on a 16-byte boundary without causing a general-protection exception (#GP) to be generated.

To move a double quadword to or from memory locations that are known to be aligned on 16-byte boundaries, use the MOVDQA instruction.

While executing in 16-bit addressing mode, a linear address for a 128-bit data access that overlaps the end of a 16-bit segment is not allowed and is defined as reserved behavior. A specific processor implementation may or may not generate a general-protection exception (#GP) in this situation, and the address that spans the end of the segment may or may not wrap around to the beginning of the segment.

In 64-bit mode, use of the REX.R prefix permits this instruction to access additional registers (XMM8-XMM15).

Operation

DEST ← SRC;

Intel C/C++ Compiler Intrinsic Equivalent

MOVDQU void _mm_storeu_si128 (__m128i *p, __m128i a)

MOVDQU __m128i _mm_loadu_si128 (__m128i *p)

SIMD Floating-Point Exceptions

None.

Protected Mode Exceptions

#AC(0)	If alignment checking is enabled and an unaligned memory reference is made.
#GP(0)	If a memory operand effective address is outside the CS, DS, ES, FS, or GS segment limit.
#SS(0)	If a memory operand effective address is outside the SS segment limit.
#NM	If CR0.TS[bit 3] = 1.
#UD	If CR0.EM[bit 2] = 1. If CR4.OSFXSR[bit 9] = 0. If CPUID.01H:EDX.SSE2[bit 26] = 0.
#PF(fault-code)	If a page fault occurs.

Real-Address Mode Exceptions

#GP	If any part of the operand lies outside of the effective address space from 0 to FFFFH.
#NM	If CR0.TS[bit 3] = 1.
#UD	If CR0.EM[bit 2] = 1. If CR4.OSFXSR[bit 9] = 0. If CPUID.01H:EDX.SSE2[bit 26] = 0. If the LOCK prefix is used.

Virtual-8086 Mode Exceptions

Same exceptions as in real address mode.

#AC(0)	If alignment checking is enabled and an unaligned memory reference is made.
#PF(fault-code)	For a page fault.

Compatibility Mode Exceptions

Same exceptions as in protected mode.

64-Bit Mode Exceptions

#AC(0)	If alignment checking is enabled and an unaligned memory reference is made.
#SS(0)	If a memory address referencing the SS segment is in a non-canonical form.
#GP(0)	If the memory address is in a non-canonical form.
#PF(fault-code)	For a page fault.
#NM	If CR0.TS[bit 3] = 1.

#UD

If CR0.EM[bit 2] = 1.

If CR4.OSFXSR[bit 9] = 0.

If CPUID.01H:EDX.SSE2[bit 26] = 0.

If the LOCK prefix is used.

MOVDQ2Q—Move Quadword from XMM to MMX Technology Register

Opcode	Instruction	64-Bit Mode	Compat/Leg Mode	Description
F2 0F D6	MOVDQ2Q <i>mm, xmm</i>	Valid	Valid	Move low quadword from <i>xmm</i> to <i>mmx</i> register.

Description

Moves the low quadword from the source operand (second operand) to the destination operand (first operand). The source operand is an XMM register and the destination operand is an MMX technology register.

This instruction causes a transition from x87 FPU to MMX technology operation (that is, the x87 FPU top-of-stack pointer is set to 0 and the x87 FPU tag word is set to all 0s [valid]). If this instruction is executed while an x87 FPU floating-point exception is pending, the exception is handled before the MOVDQ2Q instruction is executed.

In 64-bit mode, use of the REX.R prefix permits this instruction to access additional registers (XMM8-XMM15).

Operation

DEST ← SRC[63:0];

Intel C/C++ Compiler Intrinsic Equivalent

MOVDQ2Q __m64 _mm_movepi64_pi64 (__m128i a)

SIMD Floating-Point Exceptions

None.

Protected Mode Exceptions

#NM If CR0.TS[bit 3] = 1.
 #UD If CR0.EM[bit 2] = 1.
 If CR4.OSFXSR[bit 9] = 0.
 If CPUID.01H:EDX.SSE2[bit 26] = 0.
 If the LOCK prefix is used.
 #MF If there is a pending x87 FPU exception.

Real-Address Mode Exceptions

Same exceptions as in protected mode.

Virtual-8086 Mode Exceptions

Same exceptions as in protected mode.

Compatibility Mode Exceptions

Same exceptions as in protected mode.

64-Bit Mode Exceptions

Same exceptions as in protected mode.

MOVHLPS— Move Packed Single-Precision Floating-Point Values High to Low

Opcode	Instruction	64-Bit Mode	Compat/Leg Mode	Description
OF 12 /r	MOVHLPS <i>xmm1</i> , <i>xmm2</i>	Valid	Valid	Move two packed single-precision floating-point values from high quadword of <i>xmm2</i> to low quadword of <i>xmm1</i> .

Description

Moves two packed single-precision floating-point values from the high quadword of the source operand (second operand) to the low quadword of the destination operand (first operand). The high quadword of the destination operand is left unchanged.

In 64-bit mode, use of the REX.R prefix permits this instruction to access additional registers (XMM8-XMM15).

Operation

DEST[63:0] ← SRC[127:64];
 (* DEST[127:64] unchanged *)

Intel C/C++ Compiler Intrinsic Equivalent

MOVHLPS __m128 __mm_movehl_ps(__m128 a, __m128 b)

SIMD Floating-Point Exceptions

None.

Protected Mode Exceptions

#NM If CR0.TS[bit 3] = 1.
 #UD If CR0.EM[bit 2] = 1.
 If CR4.OSFXSR[bit 9] = 0.
 If CPUID.01H:EDX.SSE[bit 25] = 0.
 If the LOCK prefix is used.

Real Address Mode Exceptions

Same exceptions as in protected mode.

Virtual 8086 Mode Exceptions

Same exceptions as in protected mode.

Compatibility Mode Exceptions

Same exceptions as in protected mode.

64-Bit Mode Exceptions

Same exceptions as in protected mode.

MOVHPD—Move High Packed Double-Precision Floating-Point Value

Opcode	Instruction	64-Bit Mode	Compat/ Leg Mode	Description
66 0F 16 /r	MOVHPD <i>xmm</i> , <i>m64</i>	Valid	Valid	Move double-precision floating-point value from <i>m64</i> to high quadword of <i>xmm</i> .
66 0F 17 /r	MOVHPD <i>m64</i> , <i>xmm</i>	Valid	Valid	Move double-precision floating-point value from high quadword of <i>xmm</i> to <i>m64</i> .

Description

Moves a double-precision floating-point value from the source operand (second operand) to the destination operand (first operand). The source and destination operands can be an XMM register or a 64-bit memory location. This instruction allows a double-precision floating-point value to be moved to and from the high quadword of an XMM register and memory. It cannot be used for register to register or memory to memory moves. When the destination operand is an XMM register, the low quadword of the register remains unchanged.

In 64-bit mode, use of the REX.R prefix permits this instruction to access additional registers (XMM8-XMM15).

Operation

MOVHPD instruction for memory to XMM move:

```
DEST[127:64] ← SRC;
(* DEST[63:0] unchanged *)
```

MOVHPD instruction for XMM to memory move:

```
DEST ← SRC[127:64];
```

Intel C/C++ Compiler Intrinsic Equivalent

```
MOVHPD __m128d _mm_loadh_pd ( __m128d a, double *p)
```

```
MOVHPD void _mm_storeh_pd (double *p, __m128d a)
```

SIMD Floating-Point Exceptions

None.

Protected Mode Exceptions

#GP(0)	For an illegal memory operand effective address in the CS, DS, ES, FS or GS segments.
#SS(0)	For an illegal address in the SS segment.
#PF(fault-code)	For a page fault.
#NM	If CR0.TS[bit 3] = 1.
#UD	If CR0.EM[bit 2] = 1. If CR4.OSFXSR[bit 9] = 0. If CPUID.01H:EDX.SSE2[bit 26] = 0. If the LOCK prefix is used.
#AC(0)	If alignment checking is enabled and an unaligned memory reference is made while the current privilege level is 3.

Real-Address Mode Exceptions

GP	If any part of the operand lies outside the effective address space from 0 to FFFFH.
#NM	If CR0.TS[bit 3] = 1.
#UD	If CR0.EM[bit 2] = 1. If CR4.OSFXSR[bit 9] = 0. If CPUID.01H:EDX.SSE2[bit 26] = 0. If the LOCK prefix is used.

Virtual-8086 Mode Exceptions

Same exceptions as in real address mode.

#PF(fault-code)	For a page fault.
#AC(0)	If alignment checking is enabled and an unaligned memory reference is made.

Compatibility Mode Exceptions

Same exceptions as in protected mode.

64-Bit Mode Exceptions

#SS(0)	If a memory address referencing the SS segment is in a non-canonical form.
#GP(0)	If the memory address is in a non-canonical form.
#PF(fault-code)	For a page fault.
#NM	If CR0.TS[bit 3] = 1.
#UD	If CR0.EM[bit 2] = 1. If CR4.OSFXSR[bit 9] = 0.

#AC(0) If CPUID.01H:EDX.SSE2[bit 26] = 0.
 If the LOCK prefix is used.
 If alignment checking is enabled and an unaligned memory
 reference is made while the current privilege level is 3.

MOVHPS—Move High Packed Single-Precision Floating-Point Values

Opcode	Instruction	64-Bit Mode	Compat/Leg Mode	Description
OF 16 /r	MOVHPS <i>xmm</i> , <i>m64</i>	Valid	Valid	Move two packed single-precision floating-point values from <i>m64</i> to high quadword of <i>xmm</i> .
OF 17 /r	MOVHPS <i>m64</i> , <i>xmm</i>	Valid	Valid	Move two packed single-precision floating-point values from high quadword of <i>xmm</i> to <i>m64</i> .

Description

Moves two packed single-precision floating-point values from the source operand (second operand) to the destination operand (first operand). The source and destination operands can be an XMM register or a 64-bit memory location. This instruction allows two single-precision floating-point values to be moved to and from the high quadword of an XMM register and memory. It cannot be used for register to register or memory to memory moves. When the destination operand is an XMM register, the low quadword of the register remains unchanged.

In 64-bit mode, use of the REX.R prefix permits this instruction to access additional registers (XMM8-XMM15).

Operation

MOVHPS instruction for memory to XMM move:

```
DEST[127:64] ← SRC;
(* DEST[63:0] unchanged *)
```

MOVHPS instruction for XMM to memory move:

```
DEST ← SRC[127:64];
```

Intel C/C++ Compiler Intrinsic Equivalent

```
MOVHPS  __m128d _mm_loadh_pi ( __m128d a, __m64 *p)
```

```
MOVHPS  void _mm_storeh_pi ( __m64 *p, __m128d a)
```

SIMD Floating-Point Exceptions

None.

Protected Mode Exceptions

#GP(0) For an illegal memory operand effective address in the CS, DS, ES, FS or GS segments.

#SS(0)	For an illegal address in the SS segment.
#PF(fault-code)	For a page fault.
#NM	If CR0.TS[bit 3] = 1.
#UD	If CR0.EM[bit 2] = 1. If CR4.OSFXSR[bit 9] = 0. If CPUID.01H: EDX.SSE[bit 25] = 0. If the LOCK prefix is used.
#AC(0)	If alignment checking is enabled and an unaligned memory reference is made while the current privilege level is 3.

Real-Address Mode Exceptions

GP	If any part of the operand lies outside the effective address space from 0 to FFFFH.
#NM	If CR0.TS[bit 3] = 1.
#UD	If CR0.EM[bit 2] = 1. If CR4.OSFXSR[bit 9] = 0. If CPUID.01H: EDX.SSE[bit 25] = 0. If the LOCK prefix is used.

Virtual-8086 Mode Exceptions

Same exceptions as in real address mode.

#PF(fault-code)	For a page fault.
#AC(0)	If alignment checking is enabled and an unaligned memory reference is made.

Compatibility Mode Exceptions

Same exceptions as in protected mode.

64-Bit Mode Exceptions

#SS(0)	If a memory address referencing the SS segment is in a non-canonical form.
#GP(0)	If the memory address is in a non-canonical form.
#PF(fault-code)	For a page fault.
#NM	If CR0.TS[bit 3] = 1.
#UD	If CR0.EM[bit 2] = 1. If CR4.OSFXSR[bit 9] = 0. If CPUID.01H: EDX.SSE[bit 25] = 0. If the LOCK prefix is used.

#AC(0)

If alignment checking is enabled and an unaligned memory reference is made while the current privilege level is 3.

MOVLHPS—Move Packed Single-Precision Floating-Point Values Low to High

Opcode	Instruction	64-Bit Mode	Compat/ Leg Mode	Description
OF 16 /r	MOVLHPS <i>xmm1</i> , <i>xmm2</i>	Valid	Valid	Move two packed single-precision floating-point values from low quadword of <i>xmm2</i> to high quadword of <i>xmm1</i> .

Description

Moves two packed single-precision floating-point values from the low quadword of the source operand (second operand) to the high quadword of the destination operand (first operand). The low quadword of the destination operand is left unchanged.

In 64-bit mode, use of the REX.R prefix permits this instruction to access additional registers (XMM8-XMM15).

Operation

DEST[127:64] ← SRC[63:0];
(* DEST[63:0] unchanged *)

Intel C/C++ Compiler Intrinsic Equivalent

MOVLHPS __m128 __mm_movelh_ps(__m128 a, __m128 b)

SIMD Floating-Point Exceptions

None.

Protected Mode Exceptions

#NM If CR0.TS[bit 3] = 1.
#UD If CR0.EM[bit 2] = 1.
If CR4.OSFXSR[bit 9] = 0.
If CPUID.01H: EDX.SSE[bit 25] = 0.
If the LOCK prefix is used.

Real Address Mode Exceptions

Same exceptions as in protected mode.

Virtual 8086 Mode Exceptions

Same exceptions as in protected mode.

Compatibility Mode Exceptions

Same exceptions as in protected mode.

64-Bit Mode Exceptions

Same exceptions as in protected mode.

MOVLPD—Move Low Packed Double-Precision Floating-Point Value

Opcode	Instruction	64-Bit Mode	Compat/Leg Mode	Description
66 0F 12 /r	MOVLPD <i>xmm</i> , <i>m64</i>	Valid	Valid	Move double-precision floating-point value from <i>m64</i> to low quadword of <i>xmm</i> register.
66 0F 13 /r	MOVLPD <i>m64</i> , <i>xmm</i>	Valid	Valid	Move double-precision floating-point value from low quadword of <i>xmm</i> register to <i>m64</i> .

Description

Moves a double-precision floating-point value from the source operand (second operand) to the destination operand (first operand). The source and destination operands can be an XMM register or a 64-bit memory location. This instruction allows a double-precision floating-point value to be moved to and from the low quadword of an XMM register and memory. It cannot be used for register to register or memory to memory moves. When the destination operand is an XMM register, the high quadword of the register remains unchanged.

In 64-bit mode, use of the REX.R prefix permits this instruction to access additional registers (XMM8-XMM15).

Operation

MOVLPD instruction for memory to XMM move:

DEST[63:0] ← SRC;
(* DEST[127:64] unchanged *)

MOVLPD instruction for XMM to memory move:

DEST ← SRC[63:0];

Intel C/C++ Compiler Intrinsic Equivalent

MOVLPD `__m128d _mm_loadl_pd (__m128d a, double *p)`

MOVLPD `void _mm_storel_pd (double *p, __m128d a)`

SIMD Floating-Point Exceptions

None.

Protected Mode Exceptions

#GP(0) For an illegal memory operand effective address in the CS, DS, ES, FS or GS segments.

#SS(0)	For an illegal address in the SS segment.
#PF(fault-code)	For a page fault.
#NM	If CR0.TS[bit 3] = 1.
#UD	If CR0.EM[bit 2] = 1. If CR4.OSFXSR[bit 9] = 0. If CPUID.01H:EDX.SSE2[bit 26] = 0. If the LOCK prefix is used.
#AC(0)	If alignment checking is enabled and an unaligned memory reference is made while the current privilege level is 3.

Real-Address Mode Exceptions

GP	If any part of the operand lies outside the effective address space from 0 to FFFFH.
#NM	If CR0.TS[bit 3] = 1.
#UD	If CR0.EM[bit 2] = 1. If CR4.OSFXSR[bit 9] = 0. If CPUID.01H:EDX.SSE2[bit 26] = 0.

Virtual-8086 Mode Exceptions

Same exceptions as in real address mode.

#PF(fault-code)	For a page fault.
#AC(0)	If alignment checking is enabled and an unaligned memory reference is made.

Compatibility Mode Exceptions

Same exceptions as in protected mode.

64-Bit Mode Exceptions

#SS(0)	If a memory address referencing the SS segment is in a non-canonical form.
#GP(0)	If the memory address is in a non-canonical form.
#PF(fault-code)	For a page fault.
#NM	If CR0.TS[bit 3] = 1.
#UD	If CR0.EM[bit 2] = 1. If CR4.OSFXSR[bit 9] = 0. If CPUID.01H:EDX.SSE2[bit 26] = 0. If the LOCK prefix is used.
#AC(0)	If alignment checking is enabled and an unaligned memory reference is made while the current privilege level is 3.

MOVLPS—Move Low Packed Single-Precision Floating-Point Values

Opcode	Instruction	64-Bit Mode	Compat/ Leg Mode	Description
0F 12 /r	MOVLPS <i>xmm</i> , <i>m64</i>	Valid	Valid	Move two packed single-precision floating-point values from <i>m64</i> to low quadword of <i>xmm</i> .
0F 13 /r	MOVLPS <i>m64</i> , <i>xmm</i>	Valid	Valid	Move two packed single-precision floating-point values from low quadword of <i>xmm</i> to <i>m64</i> .

Description

Moves two packed single-precision floating-point values from the source operand (second operand) and the destination operand (first operand). The source and destination operands can be an XMM register or a 64-bit memory location. This instruction allows two single-precision floating-point values to be moved to and from the low quadword of an XMM register and memory. It cannot be used for register to register or memory to memory moves. When the destination operand is an XMM register, the high quadword of the register remains unchanged.

In 64-bit mode, use of the REX.R prefix permits this instruction to access additional registers (XMM8-XMM15).

Operation

MOVLPS instruction for memory to XMM move:

DEST[63:0] ← SRC;
 (* DEST[127:64] unchanged *)

MOVLPS instruction for XMM to memory move:

DEST ← SRC[63:0];

Intel C/C++ Compiler Intrinsic Equivalent

MOVLPS `__m128 _mm_loadl_pi (__m128 a, __m64 *p)`

MOVLPS `void _mm_storel_pi (__m64 *p, __m128 a)`

SIMD Floating-Point Exceptions

None.

Protected Mode Exceptions

#GP(0) For an illegal memory operand effective address in the CS, DS, ES, FS or GS segments.

#SS(0)	For an illegal address in the SS segment.
#PF(fault-code)	For a page fault.
#NM	If CR0.TS[bit 3] = 1.
#UD	If CR0.EM[bit 2] = 1. If CR4.OSFXSR[bit 9] = 0. If CPUID.01H: EDX.SSE[bit 25] = 0. If the LOCK prefix is used.
#AC(0)	If alignment checking is enabled and an unaligned memory reference is made while the current privilege level is 3.

Real-Address Mode Exceptions

GP	If any part of the operand lies outside the effective address space from 0 to FFFFH.
#NM	If CR0.TS[bit 3] = 1.
#UD	If CR0.EM[bit 2] = 1. If CR4.OSFXSR[bit 9] = 0. If CPUID.01H: EDX.SSE[bit 25] = 0. If the LOCK prefix is used.

Virtual-8086 Mode Exceptions

Same exceptions as in real address mode.

#PF(fault-code)	For a page fault.
#AC(0)	If alignment checking is enabled and an unaligned memory reference is made.

Compatibility Mode Exceptions

Same exceptions as in protected mode.

64-Bit Mode Exceptions

#SS(0)	If a memory address referencing the SS segment is in a non-canonical form.
#GP(0)	If the memory address is in a non-canonical form.
#PF(fault-code)	For a page fault.
#NM	If CR0.TS[bit 3] = 1.
#UD	If CR0.EM[bit 2] = 1. If CR4.OSFXSR[bit 9] = 0. If CPUID.01H: EDX.SSE[bit 25] = 0. If the LOCK prefix is used.

INSTRUCTION SET REFERENCE, A-M

#AC(0)

If alignment checking is enabled and an unaligned memory reference is made while the current privilege level is 3.

MOVMSKPD—Extract Packed Double-Precision Floating-Point Sign Mask

Opcode	Instruction	64-Bit Mode	Compat/ Leg Mode	Description
66 0F 50 /r	MOVMSKPD <i>reg</i> , <i>xmm</i>	Valid	Valid	Extract 2-bit sign mask from <i>xmm</i> and store in <i>reg</i> . The upper bits of r32 or r64 are filled with zeros.

Description

Extracts the sign bits from the packed double-precision floating-point values in the source operand (second operand), formats them into a 2-bit mask, and stores the mask in the destination operand (first operand). The source operand is an XMM register, and the destination operand is a general-purpose register. The mask is stored in the 2 low-order bits of the destination operand. Zero-extend the upper bits of the destination.

In 64-bit mode, the instruction can access additional registers (XMM8-XMM15, R8-R15) when used with a REX.R prefix. The default operand size is 64-bit in 64-bit mode.

Operation

```
DEST[0] ← SRC[63];
DEST[1] ← SRC[127];
```

```
IF DEST = r32
  THEN DEST[31:2] ← ZeroExtend;
  ELSE DEST[63:2] ← ZeroExtend;
FI;
```

Intel C/C++ Compiler Intrinsic Equivalent

```
MOVMSKPD    int _mm_movemask_pd ( __m128d a)
```

SIMD Floating-Point Exceptions

None.

Protected Mode Exceptions

```
#NM          If CR0.TS[bit 3] = 1.
#UD          If CR0.EM[bit 2] = 1.
              If CR4.OSFXSR[bit 9] = 0.
```

If CPUID.01H: EDX.SSE2[bit 26] = 0.
If the LOCK prefix is used.

Real-Address Mode Exceptions

Same exceptions as in protected mode.

Virtual-8086 Mode Exceptions

Same exceptions as in protected mode.

Compatibility Mode Exceptions

Same exceptions as in protected mode.

64-Bit Mode Exceptions

Same exceptions as in protected mode.

MOVMSKPS—Extract Packed Single-Precision Floating-Point Sign Mask

Opcode	Instruction	64-Bit Mode	Compat/ Leg Mode	Description
OF 50 /r	MOVMSKPS <i>reg</i> , <i>xmm</i>	Valid	Valid	Extract 4-bit sign mask from <i>xmm</i> and store in <i>reg</i> . The upper bits of r32 or r64 are filled with zeros.

Description

Extracts the sign bits from the packed single-precision floating-point values in the source operand (second operand), formats them into a 4-bit mask, and stores the mask in the destination operand (first operand). The source operand is an XMM register, and the destination operand is a general-purpose register. The mask is stored in the 4 low-order bits of the destination operand. Zero-extend the upper bits of the destination operand.

In 64-bit mode, the instruction can access additional registers (XMM8-XMM15, R8-R15) when used with a REX.R prefix. The default operand size is 64-bit in 64-bit mode.

Operation

```
DEST[0] ← SRC[31];
DEST[1] ← SRC[63];
DEST[2] ← SRC[95];
DEST[3] ← SRC[127];
```

```
IF DEST = r32
  THEN DEST[31:4] ← ZeroExtend;
  ELSE DEST[63:4] ← ZeroExtend;
FI;
```

Intel C/C++ Compiler Intrinsic Equivalent

```
int _mm_movemask_ps(__m128 a)
```

SIMD Floating-Point Exceptions

None.

Protected Mode Exceptions

```
#NM          If CR0.TS[bit 3] = 1.
#UD          If CR0.EM[bit 2] = 1.
             If CR4.OSFXSR[bit 9] = 0.
```

If CPUID.01H: EDX.SSE[bit 25] = 0.
If the LOCK prefix is used.

Real-Address Mode Exceptions

Same exceptions as in protected mode.

Virtual 8086 Mode Exceptions

Same exceptions as in protected mode.

Compatibility Mode Exceptions

Same exceptions as in protected mode.

64-Bit Mode Exceptions

Same exceptions as in protected mode.

MOVNTDQA – Load Double Quadword Non-Temporal Aligned Hint

Opcode	Instruction	64-bit Mode	Compat/ Leg Mode	Description
66 OF 38 2A /r	MOVNTDQA <i>xmm1</i> , <i>m128</i>	Valid	Valid	Move double quadword from <i>m128</i> to <i>xmm</i> using non-temporal hint if WC memory type.

Description

MOVNTDQA loads a double quadword from the source operand (second operand) to the destination operand (first operand) using a non-temporal hint. A processor implementation may make use of the non-temporal hint associated with this instruction if the memory source is WC (write combining) memory type. An implementation may also make use of the non-temporal hint associated with this instruction if the memory source is WB (write back) memory type.

A processor's implementation of the non-temporal hint does not override the effective memory type semantics, but the implementation of the hint is processor dependent. For example, a processor implementation may choose to ignore the hint and process the instruction as a normal MOVDQA for any memory type. Another implementation of the hint for WC memory type may optimize data transfer throughput of WC reads. A third implementation may optimize cache reads generated by MOVNTDQA on WB memory type to reduce cache evictions.

WC Streaming Load Hint

For WC memory type in particular, the processor never appears to read the data into the cache hierarchy. Instead, the non-temporal hint may be implemented by loading a temporary internal buffer with the equivalent of an aligned cache line without filling this data to the cache. Any memory-type aliased lines in the cache will be snooped and flushed. Subsequent MOVNTDQA reads to unread portions of the WC cache line will receive data from the temporary internal buffer if data is available. The temporary internal buffer may be flushed by the processor at any time for any reason, for example:

- A load operation other than a MOVNTDQA which references memory already resident in a temporary internal buffer.
- A non-WC reference to memory already resident in a temporary internal buffer.
- Interleaving of reads and writes to memory currently residing in a single temporary internal buffer.
- Repeated MOVNTDQA loads of a particular 16-byte item in a streaming line.
- Certain micro-architectural conditions including resource shortages, detection of a mis-speculation condition, and various fault conditions

The memory type of the region being read can override the non-temporal hint, if the memory address specified for the non-temporal read is not a WC memory region.

Information on non-temporal reads and writes can be found in Chapter 11, “Memory Cache Control” of *Intel® 64 and IA-32 Architectures Software Developer’s Manual, Volume 3A*.

Because the WC protocol uses a weakly-ordered memory consistency model, an MFENCE or locked instruction should be used in conjunction with MOVNTDQA instructions if multiple processors might reference the same WC memory locations or in order to synchronize reads of a processor with writes by other agents in the system. Because of the speculative nature of fetching due to MOVNTDQA, Streaming loads must not be used to reference memory addresses that are mapped to I/O devices having side effects or when reads to these devices are destructive. For additional information on MOVNTDQA usages, see Section 12.10.3 in Chapter 12, “Programming with SSE3, SSSE3 and SSE4” of *Intel® 64 and IA-32 Architectures Software Developer’s Manual, Volume 1*.

Operation

DST ← SRC;

Intel C/C++ Compiler Intrinsic Equivalent

```
MOVNTDQA __m128i _mm_stream_load_si128 (__m128i *p);
```

Flags Affected

None

Protected Mode Exceptions

#GP(0)	For an illegal memory operand effective address in the CS, DS, ES, FS, or GS segments. If a memory operand is not aligned on a 16-byte boundary, regardless of segment.
#SS(0)	For an illegal address in the SS segment.
#PF(fault-code)	For a page fault.
#NM	If CR0.TS[bit 3] = 1.
#UD	If CR0.EM[bit 2] = 1. If CR4.OSFXSR[bit 9] = 0. If CPUID.01H:ECX.SSE4_1[bit 19] = 0. If LOCK prefix is used. Either the prefix REP (F3h) or REPN (F2h) is used.

Real Mode Exceptions

#GP(0)	if any part of the operand lies outside of the effective address space from 0 to 0FFFFH.
--------	------------------------------------------------------------------------------------------

	If a memory operand is not aligned on a 16-byte boundary, regardless of segment.
#NM	If CR0.TS[bit 3] = 1.
#UD	If CR0.EM[bit 2] = 1. If CR4.OSFXSR[bit 9] = 0. If CPUID.01H:ECX.SSE4_1[bit 19] = 0. If LOCK prefix is used. Either the prefix REP (F3h) or REPN (F2H) is used.

Virtual 8086 Mode Exceptions

Same exceptions as in Real Address Mode.

#PF(fault-code) For a page fault.

Compatibility Mode Exceptions

Same exceptions as in Protected Mode.

64-Bit Mode Exceptions

#GP(0)	If the memory address is in a non-canonical form. If a memory operand is not aligned on a 16-byte boundary, regardless of segment.
#SS(0)	If a memory address referencing the SS segment is in a non-canonical form.
#PF(fault-code)	For a page fault.
#NM	If TS in CR0 is set.
#UD	If EM in CR0 is set. If OSFXSR in CR4 is 0. If CPUID feature flag ECX.SSE4_1 is 0. If LOCK prefix is used. Either the prefix REP (F3h) or REPN (F2H) is used.

MOVNTDQ—Store Double Quadword Using Non-Temporal Hint

Opcode	Instruction	64-Bit Mode	Compat/Leg Mode	Description
66 0F E7 /r	MOVNTDQ <i>m128</i> , <i>xmm</i>	Valid	Valid	Move double quadword from <i>xmm</i> to <i>m128</i> using non-temporal hint.

Description

Moves the double quadword in the source operand (second operand) to the destination operand (first operand) using a non-temporal hint to prevent caching of the data during the write to memory. The source operand is an XMM register, which is assumed to contain integer data (packed bytes, words, doublewords, or quadwords). The destination operand is a 128-bit memory location.

The non-temporal hint is implemented by using a write combining (WC) memory type protocol when writing the data to memory. Using this protocol, the processor does not write the data into the cache hierarchy, nor does it fetch the corresponding cache line from memory into the cache hierarchy. The memory type of the region being written to can override the non-temporal hint, if the memory address specified for the non-temporal store is in an uncacheable (UC) or write protected (WP) memory region. For more information on non-temporal stores, see “Caching of Temporal vs. Non-Temporal Data” in Chapter 10 in the *Intel® 64 and IA-32 Architectures Software Developer’s Manual, Volume 1*.

Because the WC protocol uses a weakly-ordered memory consistency model, a fencing operation implemented with the SFENCE or MFENCE instruction should be used in conjunction with MOVNTDQ instructions if multiple processors might use different memory types to read/write the destination memory locations.

In 64-bit mode, use of the REX.R prefix permits this instruction to access additional registers (XMM8-XMM15).

Operation

DEST ← SRC;

Intel C/C++ Compiler Intrinsic Equivalent

MOVNTDQ void _mm_stream_pd(double* p, __m128d a)

SIMD Floating-Point Exceptions

None.

Protected Mode Exceptions

#GP(0)	For an illegal memory operand effective address in the CS, DS, ES, FS or GS segments. If a memory operand is not aligned on a 16-byte boundary, regardless of segment.
#SS(0)	For an illegal address in the SS segment.
#PF(fault-code)	For a page fault.
#NM	If CR0.TS[bit 3] = 1.
#UD	If CR0.EM[bit 2] = 1. If CR4.OSFXSR[bit 9] = 0. If CPUID.01H:EDX.SSE2[bit 26] = 0. If the LOCK prefix is used.

Real-Address Mode Exceptions

#GP	If a memory operand is not aligned on a 16-byte boundary, regardless of segment. If any part of the operand lies outside the effective address space from 0 to FFFFH.
#NM	If CR0.TS[bit 3] = 1.
#UD	If CR0.EM[bit 2] = 1. If CR4.OSFXSR[bit 9] = 0. If CPUID.01H:EDX.SSE2[bit 26] = 0. If the LOCK prefix is used.

Virtual-8086 Mode Exceptions

Same exceptions as in real address mode.

#PF(fault-code)	For a page fault.
-----------------	-------------------

Compatibility Mode Exceptions

Same exceptions as in protected mode.

64-Bit Mode Exceptions

#SS(0)	If a memory address referencing the SS segment is in a non-canonical form.
#GP(0)	If the memory address is in a non-canonical form. If memory operand is not aligned on a 16-byte boundary, regardless of segment.
#PF(fault-code)	For a page fault.
#NM	If CR0.TS[bit 3] = 1.

#UD

If CR0.EM[bit 2] = 1.
If CR4.OSFXSR[bit 9] = 0.
If CPUID.01H:EDX.SSE2[bit 26] = 0.
If the LOCK prefix is used.

MOVNTI—Store Doubleword Using Non-Temporal Hint

Opcode	Instruction	64-Bit Mode	Compat/Leg Mode	Description
OF C3 /r	MOVNTI <i>m32, r32</i>	Valid	Valid	Move doubleword from <i>r32</i> to <i>m32</i> using non-temporal hint.
REX.W + OF C3 /r	MOVNTI <i>m64, r64</i>	Valid	N.E.	Move quadword from <i>r64</i> to <i>m64</i> using non-temporal hint.

Description

Moves the doubleword integer in the source operand (second operand) to the destination operand (first operand) using a non-temporal hint to minimize cache pollution during the write to memory. The source operand is a general-purpose register. The destination operand is a 32-bit memory location.

The non-temporal hint is implemented by using a write combining (WC) memory type protocol when writing the data to memory. Using this protocol, the processor does not write the data into the cache hierarchy, nor does it fetch the corresponding cache line from memory into the cache hierarchy. The memory type of the region being written to can override the non-temporal hint, if the memory address specified for the non-temporal store is in an uncacheable (UC) or write protected (WP) memory region. For more information on non-temporal stores, see “Caching of Temporal vs. Non-Temporal Data” in Chapter 10 in the *Intel® 64 and IA-32 Architectures Software Developer’s Manual, Volume 1*.

Because the WC protocol uses a weakly-ordered memory consistency model, a fencing operation implemented with the SFENCE or MFENCE instruction should be used in conjunction with MOVNTI instructions if multiple processors might use different memory types to read/write the destination memory locations.

In 64-bit mode, the instruction’s default operation size is 32 bits. Use of the REX.R prefix permits access to additional registers (R8-R15). Use of the REX.W prefix promotes operation to 64 bits. See the summary chart at the beginning of this section for encoding data and limits.

Operation

DEST ← SRC;

Intel C/C++ Compiler Intrinsic Equivalent

MOVNTI void _mm_stream_si32 (int *p, int a)

SIMD Floating-Point Exceptions

None.

Protected Mode Exceptions

#GP(0)	For an illegal memory operand effective address in the CS, DS, ES, FS or GS segments.
#SS(0)	For an illegal address in the SS segment.
#PF(fault-code)	For a page fault.
#UD	If CPUID.01H: EDX.SSE2[bit 26] = 0. If the LOCK prefix is used.

Real-Address Mode Exceptions

#GP	If a memory operand is not aligned on a 16-byte boundary, regardless of segment. If any part of the operand lies outside the effective address space from 0 to FFFFH.
#UD	If CPUID.01H: EDX.SSE2[bit 26] = 0. If the LOCK prefix is used.

Virtual-8086 Mode Exceptions

Same exceptions as in real address mode.

#PF(fault-code)	For a page fault.
-----------------	-------------------

Compatibility Mode Exceptions

Same exceptions as in protected mode.

64-Bit Mode Exceptions

#SS(0)	If a memory address referencing the SS segment is in a non-canonical form.
#GP(0)	If the memory address is in a non-canonical form.
#PF(fault-code)	For a page fault.
#UD	If CPUID.01H: EDX.SSE2[bit 26] = 0. If the LOCK prefix is used.
#AC(0)	If alignment checking is enabled and an unaligned memory reference is made while the current privilege level is 3.

MOVNTPD—Store Packed Double-Precision Floating-Point Values Using Non-Temporal Hint

Opcode	Instruction	64-Bit Mode	Compat/Leg Mode	Description
66 0F 2B /r	MOVNTPD <i>m128</i> , <i>xmm</i>	Valid	Valid	Move packed double-precision floating-point values from <i>xmm</i> to <i>m128</i> using non-temporal hint.

Description

Moves the double quadword in the source operand (second operand) to the destination operand (first operand) using a non-temporal hint to minimize cache pollution during the write to memory. The source operand is an XMM register, which is assumed to contain two packed double-precision floating-point values. The destination operand is a 128-bit memory location.

The non-temporal hint is implemented by using a write combining (WC) memory type protocol when writing the data to memory. Using this protocol, the processor does not write the data into the cache hierarchy, nor does it fetch the corresponding cache line from memory into the cache hierarchy. The memory type of the region being written to can override the non-temporal hint, if the memory address specified for the non-temporal store is in an uncacheable (UC) or write protected (WP) memory region. For more information on non-temporal stores, see “Caching of Temporal vs. Non-Temporal Data” in Chapter 10 in the *Intel® 64 and IA-32 Architectures Software Developer’s Manual, Volume 1*.

Because the WC protocol uses a weakly-ordered memory consistency model, a fencing operation implemented with the SFENCE or MFENCE instruction should be used in conjunction with MOVNTPD instructions if multiple processors might use different memory types to read/write the destination memory locations.

In 64-bit mode, use of the REX.R prefix permits this instruction to access additional registers (XMM8-XMM15).

Operation

DEST ← SRC;

Intel C/C++ Compiler Intrinsic Equivalent

MOVNTPD void _mm_stream_pd(double *p, __m128d a)

SIMD Floating-Point Exceptions

None.

Protected Mode Exceptions

#GP(0)	For an illegal memory operand effective address in the CS, DS, ES, FS or GS segments. If a memory operand is not aligned on a 16-byte boundary, regardless of segment.
#SS(0)	For an illegal address in the SS segment.
#PF(fault-code)	For a page fault.
#NM	If CR0.TS[bit 3] = 1.
#UD	If CR0.EM[bit 2] = 1. If CR4.OSFXSR[bit 9] = 0. If CPUID.01H:EDX.SSE2[bit 26] = 0. If the LOCK prefix is used.

Real-Address Mode Exceptions

#GP	If a memory operand is not aligned on a 16-byte boundary, regardless of segment. If any part of the operand lies outside the effective address space from 0 to FFFFH.
#NM	If CR0.TS[bit 3] = 1.
#UD	If CR0.EM[bit 2] = 1. If CR4.OSFXSR[bit 9] = 0. If CPUID.01H:EDX.SSE2[bit 26] = 0. If the LOCK prefix is used.

Virtual-8086 Mode Exceptions

Same exceptions as in real address mode.

#PF(fault-code)	For a page fault.
-----------------	-------------------

Compatibility Mode Exceptions

Same exceptions as in protected mode.

64-Bit Mode Exceptions

#SS(0)	If a memory address referencing the SS segment is in a non-canonical form.
#GP(0)	If the memory address is in a non-canonical form. If memory operand is not aligned on a 16-byte boundary, regardless of segment.
#PF(fault-code)	For a page fault.
#NM	If CR0.TS[bit 3] = 1.

#UD

If CR0.EM[bit 2] = 1.

If CR4.OSFXSR[bit 9] = 0.

If CPUID.01H:EDX.SSE2[bit 26] = 0.

If the LOCK prefix is used.

MOVNTPS—Store Packed Single-Precision Floating-Point Values Using Non-Temporal Hint

Opcode	Instruction	64-Bit Mode	Compat/Leg Mode	Description
OF 2B /r	MOVNTPS <i>m128</i> , <i>xmm</i>	Valid	Valid	Move packed single-precision floating-point values from <i>xmm</i> to <i>m128</i> using non-temporal hint.

Description

Moves the double quadword in the source operand (second operand) to the destination operand (first operand) using a non-temporal hint to minimize cache pollution during the write to memory. The source operand is an XMM register, which is assumed to contain four packed single-precision floating-point values. The destination operand is a 128-bit memory location.

The non-temporal hint is implemented by using a write combining (WC) memory type protocol when writing the data to memory. Using this protocol, the processor does not write the data into the cache hierarchy, nor does it fetch the corresponding cache line from memory into the cache hierarchy. The memory type of the region being written to can override the non-temporal hint, if the memory address specified for the non-temporal store is in an uncacheable (UC) or write protected (WP) memory region. For more information on non-temporal stores, see “Caching of Temporal vs. Non-Temporal Data” in Chapter 10 in the *Intel® 64 and IA-32 Architectures Software Developer’s Manual, Volume 1*.

Because the WC protocol uses a weakly-ordered memory consistency model, a fencing operation implemented with the SFENCE or MFENCE instruction should be used in conjunction with MOVNTPS instructions if multiple processors might use different memory types to read/write the destination memory locations.

In 64-bit mode, use of the REX.R prefix permits this instruction to access additional registers (XMM8-XMM15).

Operation

DEST ← SRC;

Intel C/C++ Compiler Intrinsic Equivalent

MOVNTDQ void _mm_stream_ps(float * p, __m128 a)

SIMD Floating-Point Exceptions

None.

Protected Mode Exceptions

#GP(0)	For an illegal memory operand effective address in the CS, DS, ES, FS or GS segments. If a memory operand is not aligned on a 16-byte boundary, regardless of segment.
#SS(0)	For an illegal address in the SS segment.
#PF(fault-code)	For a page fault.
#NM	If CR0.TS[bit 3] = 1.
#UD	If CR0.EM[bit 2] = 1. If CR4.OSFXSR[bit 9] = 0. If CPUID.01H: EDX.SSE[bit 25] = 0. If the LOCK prefix is used.

Real-Address Mode Exceptions

#GP	If a memory operand is not aligned on a 16-byte boundary, regardless of segment. If any part of the operand lies outside the effective address space from 0 to FFFFH.
#NM	If CR0.TS[bit 3] = 1.
#UD	If CR0.EM[bit 2] = 1. If CR4.OSFXSR[bit 9] = 0. If CPUID.01H: EDX.SSE2[bit 26] = 0. If the LOCK prefix is used.

Virtual-8086 Mode Exceptions

Same exceptions as in real address mode.

#PF(fault-code)	For a page fault.
-----------------	-------------------

Compatibility Mode Exceptions

Same exceptions as in protected mode.

64-Bit Mode Exceptions

#SS(0)	If a memory address referencing the SS segment is in a non-canonical form.
#GP(0)	If the memory address is in a non-canonical form. If memory operand is not aligned on a 16-byte boundary, regardless of segment.
#PF(fault-code)	For a page fault.
#NM	If CR0.TS[bit 3] = 1.

#UD

If CR0.EM[bit 2] = 1.

If CR4.OSFXSR[bit 9] = 0.

If CPUID.01H: EDX.SSE[bit 25] = 0.

If the LOCK prefix is used.

MOVNTQ—Store of Quadword Using Non-Temporal Hint

Opcode	Instruction	64-Bit Mode	Compat/Leg Mode	Description
OF E7 /r	MOVNTQ <i>m64</i> , <i>mm</i>	Valid	Valid	Move quadword from <i>mm</i> to <i>m64</i> using non-temporal hint.

Description

Moves the quadword in the source operand (second operand) to the destination operand (first operand) using a non-temporal hint to minimize cache pollution during the write to memory. The source operand is an MMX technology register, which is assumed to contain packed integer data (packed bytes, words, or doublewords). The destination operand is a 64-bit memory location.

The non-temporal hint is implemented by using a write combining (WC) memory type protocol when writing the data to memory. Using this protocol, the processor does not write the data into the cache hierarchy, nor does it fetch the corresponding cache line from memory into the cache hierarchy. The memory type of the region being written to can override the non-temporal hint, if the memory address specified for the non-temporal store is in an uncacheable (UC) or write protected (WP) memory region. For more information on non-temporal stores, see “Caching of Temporal vs. Non-Temporal Data” in Chapter 10 in the *Intel® 64 and IA-32 Architectures Software Developer’s Manual, Volume 1*.

Because the WC protocol uses a weakly-ordered memory consistency model, a fencing operation implemented with the SFENCE or MFENCE instruction should be used in conjunction with MOVNTQ instructions if multiple processors might use different memory types to read/write the destination memory locations.

This instruction’s operation is the same in non-64-bit modes and 64-bit mode.

Operation

DEST ← SRC;

Intel C/C++ Compiler Intrinsic Equivalent

```
MOVNTQ void __mm_stream_pi(__m64 * p, __m64 a)
```

SIMD Floating-Point Exceptions

None.

Protected Mode Exceptions

#GP(0) For an illegal memory operand effective address in the CS, DS, ES, FS or GS segments.

#SS(0)	For an illegal address in the SS segment.
#PF(fault-code)	For a page fault.
#NM	If CR0.TS[bit 3] = 1.
#MF	If there is a pending x87 FPU exception.
#UD	If CR0.EM[bit 2] = 1. If CPUID.01H:EDX.SSE[bit 25] = 0. If the LOCK prefix is used.
#AC(0)	If alignment checking is enabled and an unaligned memory reference is made while the current privilege level is 3.

Real-Address Mode Exceptions

#GP	If a memory operand is not aligned on a 16-byte boundary, regardless of segment. If any part of the operand lies outside the effective address space from 0 to FFFFH.
#NM	If CR0.TS[bit 3] = 1.
#MF	If there is a pending x87 FPU exception.
#UD	If CR0.EM[bit 2] = 1. If CPUID.01H:EDX.SSE2[bit 26] = 0.
#UD	If the LOCK prefix is used.

Virtual-8086 Mode Exceptions

Same exceptions as in real address mode.

#PF(fault-code)	For a page fault.
#AC(0)	If alignment checking is enabled and an unaligned memory reference is made.

Compatibility Mode Exceptions

Same exceptions as in protected mode.

64-Bit Mode Exceptions

#SS(0)	If a memory address referencing the SS segment is in a non-canonical form.
#GP(0)	If the memory address is in a non-canonical form.
#PF(fault-code)	For a page fault.
#NM	If CR0.TS[bit 3] = 1.
#MF	If there is a pending x87 FPU exception.

#UD	If CR0.EM[bit 2] = 1. If CPUID.01H:EDX.SSE[bit 25] = 0. If the LOCK prefix is used.
#AC(0)	If alignment checking is enabled and an unaligned memory reference is made while the current privilege level is 3.

MOVQ—Move Quadword

Opcode	Instruction	64-Bit Mode	Compat/ Leg Mode	Description
0F 6F /r	MOVQ <i>mm</i> , <i>mm/m64</i>	Valid	Valid	Move quadword from <i>mm/m64</i> to <i>mm</i> .
0F 7F /r	MOVQ <i>mm/m64</i> , <i>mm</i>	Valid	Valid	Move quadword from <i>mm</i> to <i>mm/m64</i> .
F3 0F 7E	MOVQ <i>xmm1</i> , <i>xmm2/m64</i>	Valid	Valid	Move quadword from <i>xmm2/mem64</i> to <i>xmm1</i> .
66 0F D6	MOVQ <i>xmm2/m64</i> , <i>xmm1</i>	Valid	Valid	Move quadword from <i>xmm1</i> to <i>xmm2/mem64</i> .

Description

Copies a quadword from the source operand (second operand) to the destination operand (first operand). The source and destination operands can be MMX technology registers, XMM registers, or 64-bit memory locations. This instruction can be used to move a quadword between two MMX technology registers or between an MMX technology register and a 64-bit memory location, or to move data between two XMM registers or between an XMM register and a 64-bit memory location. The instruction cannot be used to transfer data between memory locations.

When the source operand is an XMM register, the low quadword is moved; when the destination operand is an XMM register, the quadword is stored to the low quadword of the register, and the high quadword is cleared to all 0s.

In 64-bit mode, use of the REX prefix in the form of REX.R permits this instruction to access additional registers (XMM8-XMM15).

Operation

MOVQ instruction when operating on MMX technology registers and memory locations:

DEST ← SRC;

MOVQ instruction when source and destination operands are XMM registers:

DEST[63:0] ← SRC[63:0];

DEST[127:64] ← 0000000000000000H;

MOVQ instruction when source operand is XMM register and destination operand is memory location:

DEST ← SRC[63:0];

MOVQ instruction when source operand is memory location and destination operand is XMM register:

DEST[63:0] ← SRC;
DEST[127:64] ← 0000000000000000H;

Flags Affected

None.

Intel C/C++ Compiler Intrinsic Equivalent

MOVQ m128i_mm_mov_epi64(__m128i a)

SIMD Floating-Point Exceptions

None.

Protected Mode Exceptions

#GP(0)	If the destination operand is in a non-writable segment. If a memory operand effective address is outside the CS, DS, ES, FS, or GS segment limit.
#SS(0)	If a memory operand effective address is outside the SS segment limit.
#UD	If CR0.EM[bit 2] = 1. 128-bit operations will generate #UD only if CR4.OSFXSR[bit 9] = 0. Execution of 128-bit instructions on a non-SSE2 capable processor (one that is MMX technology capable) will result in the instruction operating on the mm registers, not #UD. If the LOCK prefix is used.
#NM	If CR0.TS[bit 3] = 1.
#MF	(MMX register operations only) If there is a pending FPU exception.
#PF(fault-code)	If a page fault occurs.
#AC(0)	If alignment checking is enabled and an unaligned memory reference is made while the current privilege level is 3.

Real-Address Mode Exceptions

#GP	If any part of the operand lies outside of the effective address space from 0 to FFFFH.
#UD	If CR0.EM[bit 2] = 1. 128-bit operations will generate #UD only if CR4.OSFXSR[bit 9] = 0. Execution of 128-bit instructions on a non-SSE2 capable

processor (one that is MMX technology capable) will result in the instruction operating on the mm registers, not #UD.

If the LOCK prefix is used.

#NM	If CR0.TS[bit 3] = 1.
#MF	(MMX register operations only) If there is a pending FPU exception.

Virtual-8086 Mode Exceptions

Same exceptions as in real address mode.

#PF(fault-code)	If a page fault occurs.
#AC(0)	If alignment checking is enabled and an unaligned memory reference is made.

Compatibility Mode Exceptions

Same exceptions as in protected mode.

64-Bit Mode Exceptions

#SS(0)	If a memory address referencing the SS segment is in a non-canonical form.
#GP(0)	If the memory address is in a non-canonical form.
#UD	If CR0.EM[bit 2] = 1. (XMM register operations only) If CR4.OSFXSR[bit 9] = 0. (XMM register operations only) If CPUID.01H:EDX.SSE2[bit 26] = 0. If the LOCK prefix is used.
#NM	If CR0.TS[bit 3] = 1.
#MF	(MMX register operations only) If there is a pending FPU exception.
#PF(fault-code)	If a page fault occurs.
#AC(0)	If alignment checking is enabled and an unaligned memory reference is made while the current privilege level is 3.

MOVQ2DQ—Move Quadword from MMX Technology to XMM Register

Opcode	Instruction	64-Bit Mode	Compat/Leg Mode	Description
F3 0F D6	MOVQ2DQ <i>xmm, mm</i>	Valid	Valid	Move quadword from <i>mmx</i> to low quadword of <i>xmm</i> .

Description

Moves the quadword from the source operand (second operand) to the low quadword of the destination operand (first operand). The source operand is an MMX technology register and the destination operand is an XMM register.

This instruction causes a transition from x87 FPU to MMX technology operation (that is, the x87 FPU top-of-stack pointer is set to 0 and the x87 FPU tag word is set to all 0s [valid]). If this instruction is executed while an x87 FPU floating-point exception is pending, the exception is handled before the MOVQ2DQ instruction is executed.

In 64-bit mode, use of the REX.R prefix permits this instruction to access additional registers (XMM8-XMM15).

Operation

```
DEST[63:0] ← SRC[63:0];
DEST[127:64] ← 0000000000000000H;
```

Intel C/C++ Compiler Intrinsic Equivalent

```
MOVQ2DQ      __128i_mm_movpi64_pi64 ( __m64 a)
```

SIMD Floating-Point Exceptions

None.

Protected Mode Exceptions

```
#NM      If CR0.TS[bit 3] = 1.
#UD      If CR0.EM[bit 2] = 1.
          If CR4.OSFXSR[bit 9] = 0.
          If CPUID.01H:EDX.SSE2[bit 26] = 0.
          If the LOCK prefix is used.
#MF      If there is a pending x87 FPU exception.
```

Real-Address Mode Exceptions

Same exceptions as in protected mode.

Virtual-8086 Mode Exceptions

Same exceptions as in protected mode.

Compatibility Mode Exceptions

Same exceptions as in protected mode.

64-Bit Mode Exceptions

Same exceptions as in protected mode.

MOVS/MOVS_B/MOVSW/MOVSD/MOVSQ—Move Data from String to String

Opcode	Instruction	64-Bit Mode	Compat/ Leg Mode	Description
A4	MOVS <i>m8, m8</i>	Valid	Valid	For legacy mode, Move byte from address DS:(E)SI to ES:(E)DI. For 64-bit mode move byte from address (R)ESI to (R)EDI.
A5	MOVS <i>m16, m16</i>	Valid	Valid	For legacy mode, move word from address DS:(E)SI to ES:(E)DI. For 64-bit mode move word at address (R)ESI to (R)EDI.
A5	MOVS <i>m32, m32</i>	Valid	Valid	For legacy mode, move dword from address DS:(E)SI to ES:(E)DI. For 64-bit mode move dword from address (R)ESI to (R)EDI.
REX.W + A5	MOVS <i>m64, m64</i>	Valid	N.E.	Move qword from address (R)ESI to (R)EDI.
A4	MOVSB	Valid	Valid	For legacy mode, Move byte from address DS:(E)SI to ES:(E)DI. For 64-bit mode move byte from address (R)ESI to (R)EDI.
A5	MOVSW	Valid	Valid	For legacy mode, move word from address DS:(E)SI to ES:(E)DI. For 64-bit mode move word at address (R)ESI to (R)EDI.
A5	MOVSD	Valid	Valid	For legacy mode, move dword from address DS:(E)SI to ES:(E)DI. For 64-bit mode move dword from address (R)ESI to (R)EDI.
REX.W + A5	MOVSQ	Valid	N.E.	Move qword from address (R)ESI to (R)EDI.

Description

Moves the byte, word, or doubleword specified with the second operand (source operand) to the location specified with the first operand (destination operand). Both the source and destination operands are located in memory. The address of the source operand is read from the DS:ESI or the DS:SI registers (depending on the address-size attribute of the instruction, 32 or 16, respectively). The address of the destination operand is read from the ES:EDI or the ES:DI registers (again depending on the address-size attribute of the instruction). The DS segment may be overridden with a segment override prefix, but the ES segment cannot be overridden.

At the assembly-code level, two forms of this instruction are allowed: the “explicit-operands” form and the “no-operands” form. The explicit-operands form (specified with the `MOVS` mnemonic) allows the source and destination operands to be specified explicitly. Here, the source and destination operands should be symbols that indicate the size and location of the source value and the destination, respectively. This explicit-operands form is provided to allow documentation; however, note that the documentation provided by this form can be misleading. That is, the source and destination operand symbols must specify the correct **type** (size) of the operands (bytes, words, or doublewords), but they do not have to specify the correct **location**. The locations of the source and destination operands are always specified by the DS: (E)SI and ES: (E)DI registers, which must be loaded correctly before the move string instruction is executed.

The no-operands form provides “short forms” of the byte, word, and doubleword versions of the `MOVS` instructions. Here also DS: (E)SI and ES: (E)DI are assumed to be the source and destination operands, respectively. The size of the source and destination operands is selected with the mnemonic: `MOVSB` (byte move), `MOVSW` (word move), or `MOVSD` (doubleword move).

After the move operation, the (E)SI and (E)DI registers are incremented or decremented automatically according to the setting of the DF flag in the EFLAGS register. (If the DF flag is 0, the (E)SI and (E)DI register are incremented; if the DF flag is 1, the (E)SI and (E)DI registers are decremented.) The registers are incremented or decremented by 1 for byte operations, by 2 for word operations, or by 4 for doubleword operations.

The `MOVS`, `MOVSB`, `MOVSW`, and `MOVSD` instructions can be preceded by the `REP` prefix (see “RDTSCP—Read Time-Stamp Counter and Processor ID” in Chapter 4, *Intel® 64 and IA-32 Architectures Software Developer’s Manual, Volume 2B*) for block moves of ECX bytes, words, or doublewords.

In 64-bit mode, the instruction’s default address size is 64 bits, 32-bit address size is supported using the prefix `67H`. The 64-bit addresses are specified by RSI and RDI; 32-bit address are specified by ESI and EDI. Use of the `REX.W` prefix promotes doubleword operation to 64 bits. See the summary chart at the beginning of this section for encoding data and limits.

Operation

DEST ← SRC;

Non-64-bit Mode:

```
IF (Byte move)
  THEN IF DF = 0
    THEN
      (E)SI ← (E)SI + 1;
      (E)DI ← (E)DI + 1;
    ELSE
```

```

        (E)SI ← (E)SI - 1;
        (E)DI ← (E)DI - 1;
    FI;
ELSE IF (Word move)
    THEN IF DF = 0
        (E)SI ← (E)SI + 2;
        (E)DI ← (E)DI + 2;
        FI;
    ELSE
        (E)SI ← (E)SI - 2;
        (E)DI ← (E)DI - 2;
    FI;
ELSE IF (Doubleword move)
    THEN IF DF = 0
        (E)SI ← (E)SI + 4;
        (E)DI ← (E)DI + 4;
        FI;
    ELSE
        (E)SI ← (E)SI - 4;
        (E)DI ← (E)DI - 4;
    FI;
FI;
64-bit Mode:
IF (Byte move)
    THEN IF DF = 0
        THEN
            (R)ESI ← (R)ESI + 1;
            (R)EDI ← (R)EDI + 1;
        ELSE
            (R)ESI ← (R)ESI - 1;
            (R)EDI ← (R)EDI - 1;
        FI;
    ELSE IF (Word move)
        THEN IF DF = 0
            (R)ESI ← (R)ESI + 2;
            (R)EDI ← (R)EDI + 2;
            FI;
        ELSE
            (R)ESI ← (R)ESI - 2;
            (R)EDI ← (R)EDI - 2;
        FI;
    ELSE IF (Doubleword move)
        THEN IF DF = 0

```

```

        (R|E)SI ← (R|E)SI + 4;
        (R|E)DI ← (R|E)DI + 4;
        FI;
    ELSE
        (R|E)SI ← (R|E)SI - 4;
        (R|E)DI ← (R|E)DI - 4;
        FI;
    ELSE IF (Quadword move)
        THEN IF DF = 0
            (R|E)SI ← (R|E)SI + 8;
            (R|E)DI ← (R|E)DI + 8;
            FI;
        ELSE
            (R|E)SI ← (R|E)SI - 8;
            (R|E)DI ← (R|E)DI - 8;
            FI;
    FI;
FI;

```

Flags Affected

None.

Protected Mode Exceptions

#GP(0)	If the destination is located in a non-writable segment. If a memory operand effective address is outside the CS, DS, ES, FS, or GS segment limit. If the DS, ES, FS, or GS register contains a NULL segment selector.
#SS(0)	If a memory operand effective address is outside the SS segment limit.
#PF(fault-code)	If a page fault occurs.
#AC(0)	If alignment checking is enabled and an unaligned memory reference is made while the current privilege level is 3.
#UD	If the LOCK prefix is used.

Real-Address Mode Exceptions

#GP	If a memory operand effective address is outside the CS, DS, ES, FS, or GS segment limit.
#SS	If a memory operand effective address is outside the SS segment limit.
#UD	If the LOCK prefix is used.

Virtual-8086 Mode Exceptions

#GP(0)	If a memory operand effective address is outside the CS, DS, ES, FS, or GS segment limit.
#SS(0)	If a memory operand effective address is outside the SS segment limit.
#PF(fault-code)	If a page fault occurs.
#AC(0)	If alignment checking is enabled and an unaligned memory reference is made.
#UD	If the LOCK prefix is used.

Compatibility Mode Exceptions

Same exceptions as in protected mode.

64-Bit Mode Exceptions

#SS(0)	If a memory address referencing the SS segment is in a non-canonical form.
#GP(0)	If the memory address is in a non-canonical form.
#PF(fault-code)	If a page fault occurs.
#AC(0)	If alignment checking is enabled and an unaligned memory reference is made while the current privilege level is 3.
#UD	If the LOCK prefix is used.

MOVSD—Move Scalar Double-Precision Floating-Point Value

Opcode	Instruction	64-Bit Mode	Compat/ Leg Mode	Description
F2 OF 10 /r	MOVSD <i>xmm1</i> , <i>xmm2/m64</i>	Valid	Valid	Move scalar double-precision floating-point value from <i>xmm2/m64</i> to <i>xmm1</i> register.
F2 OF 11 /r	MOVSD <i>xmm2/m64</i> , <i>xmm1</i>	Valid	Valid	Move scalar double-precision floating-point value from <i>xmm1</i> register to <i>xmm2/m64</i> .

Description

Moves a scalar double-precision floating-point value from the source operand (second operand) to the destination operand (first operand). The source and destination operands can be XMM registers or 64-bit memory locations. This instruction can be used to move a double-precision floating-point value to and from the low quadword of an XMM register and a 64-bit memory location, or to move a double-precision floating-point value between the low quadwords of two XMM registers. The instruction cannot be used to transfer data between memory locations.

When the source and destination operands are XMM registers, the high quadword of the destination operand remains unchanged. When the source operand is a memory location and destination operand is an XMM registers, the high quadword of the destination operand is cleared to all 0s.

In 64-bit mode, use of the REX.R prefix permits this instruction to access additional registers (XMM8-XMM15).

Operation

MOVSD instruction when source and destination operands are XMM registers:

DEST[63:0] ← SRC[63:0];
(* DEST[127:64] unchanged *)

MOVSD instruction when source operand is XMM register and destination operand is memory location:

DEST ← SRC[63:0];

MOVSD instruction when source operand is memory location and destination operand is XMM register:

DEST[63:0] ← SRC;
DEST[127:64] ← 0000000000000000H;

Intel C/C++ Compiler Intrinsic Equivalent

MOVSD __m128d _mm_load_sd (double *p)

MOVSD void _mm_store_sd (double *p, __m128d a)
 MOVSD __m128d _mm_store_sd (__m128d a, __m128d b)

SIMD Floating-Point Exceptions

None.

Protected Mode Exceptions

#GP(0) For an illegal memory operand effective address in the CS, DS, ES, FS or GS segments.

#SS(0) For an illegal address in the SS segment.

#PF(fault-code) For a page fault.

#NM If CR0.TS[bit 3] = 1.

#UD If CR0.EM[bit 2] = 1.
 If CR4.OSFXSR[bit 9] = 0.
 If CPUID.01H:EDX.SSE2[bit 26] = 0.
 If the LOCK prefix is used.

#AC(0) If alignment checking is enabled and an unaligned memory reference is made while the current privilege level is 3.

Real-Address Mode Exceptions

GP If any part of the operand lies outside the effective address space from 0 to FFFFH.

#NM If CR0.TS[bit 3] = 1.

#UD If CR0.EM[bit 2] = 1.
 If CR4.OSFXSR[bit 9] = 0.
 If CPUID.01H:EDX.SSE2[bit 26] = 0.
 If the LOCK prefix is used.

Virtual-8086 Mode Exceptions

Same exceptions as in real address mode.

#PF(fault-code) For a page fault.

#AC(0) If alignment checking is enabled and an unaligned memory reference is made.

Compatibility Mode Exceptions

Same exceptions as in protected mode.

64-Bit Mode Exceptions

#SS(0)	If a memory address referencing the SS segment is in a non-canonical form.
#GP(0)	If the memory address is in a non-canonical form.
#PF(fault-code)	For a page fault.
#NM	If CR0.TS[bit 3] = 1.
#UD	If CR0.EM[bit 2] = 1. If CR4.OSFXSR[bit 9] = 0. If CPUID.01H:EDX.SSE2[bit 26] = 0. If the LOCK prefix is used.
#AC(0)	If alignment checking is enabled and an unaligned memory reference is made while the current privilege level is 3.

MOVSHDUP—Move Packed Single-FP High and Duplicate

Opcode	Instruction	64-Bit Mode	Compat/ Leg Mode	Description
F3 0F 16 /r	MOVSHDUP <i>xmm1</i> , <i>xmm2/m128</i>	Valid	Valid	Move two single-precision floating-point values from the higher 32-bit operand of each qword in <i>xmm2/m128</i> to <i>xmm1</i> and duplicate each 32-bit operand to the lower 32-bits of each qword.

Description

The linear address corresponds to the address of the least-significant byte of the referenced memory data. When a memory address is indicated, the 16 bytes of data at memory location *m128* are loaded and the single-precision elements in positions 1 and 3 are duplicated. When the register-register form of this operation is used, the same operation is performed but with data coming from the 128-bit source register. See Figure 3-16.

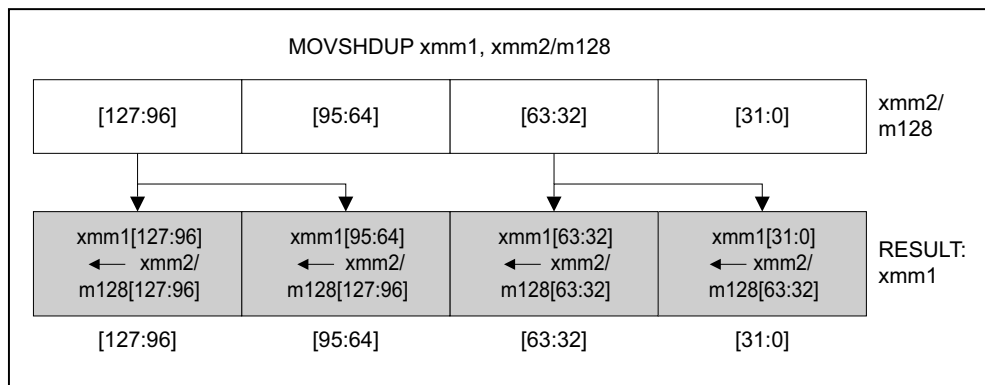

OM15998

Figure 3-16. MOVSHDUP—Move Packed Single-FP High and Duplicate

In 64-bit mode, use of the REX prefix in the form of REX.R permits this instruction to access additional registers (XMM8-XMM15).

Operation

```

IF (Source == m128)
  THEN  (* Load instruction *)
        xmm1[31:0] = m128[63:32];
        xmm1[63:32] = m128[63:32];
        xmm1[95:64] = m128[127:96];
        xmm1[127:96] = m128[127:96];
  ELSE  (* Move instruction *)
        xmm1[31:0] = xmm2[63:32];
        xmm1[63:32] = xmm2[63:32];
        xmm1[95:64] = xmm2[127:96];
        xmm1[127:96] = xmm2[127:96];
FI;

```

Intel C/C++ Compiler Intrinsic Equivalent

```
MOVSHDUP    __m128 __mm_movehdup_ps(__m128 a)
```

Exceptions

General protection exception if not aligned on 16-byte boundary, regardless of segment.

Numeric Exceptions

None

Protected Mode Exceptions

#GP(0)	For an illegal memory operand effective address in the CS, DS, ES, FS or GS segments. If memory operand is not aligned on a 16-byte boundary, regardless of segment.
#SS(0)	For an illegal address in the SS segment.
#PF(fault-code)	For a page fault.
#NM	If CR0.TS[bit 3] = 1.
#UD	If CR0.EM[bit 2] = 1. If CR4.OSFXSR[bit 9] = 0. If CPUID.01H: ECX.SSE3[bit 0] = 0. If the LOCK prefix is used.

Real Address Mode Exceptions

GP(0)	If any part of the operand would lie outside of the effective address space from 0 to 0FFFFH. If memory operand is not aligned on a 16-byte boundary, regardless of segment.
#NM	If CR0.TS[bit 3] = 1.
#UD	If CR0.EM[bit 2] = 1. If CR4.OSFXSR[bit 9] = 0. If CPUID.01H: ECX.SSE3[bit 0] = 0. If the LOCK prefix is used.

Virtual 8086 Mode Exceptions

GP(0)	If any part of the operand would lie outside of the effective address space from 0 to 0FFFFH. If memory operand is not aligned on a 16-byte boundary, regardless of segment.
#NM	If CR0.TS[bit 3] = 1.
#UD	If CR0.EM[bit 2] = 1. If CR4.OSFXSR[bit 9] = 0. If CPUID.01H: ECX.SSE3[bit 0] = 0. If the LOCK prefix is used.
#PF(fault-code)	For a page fault.

Compatibility Mode Exceptions

Same exceptions as in protected mode.

64-Bit Mode Exceptions

#SS(0)	If a memory address referencing the SS segment is not non-canonical.
#GP(0)	If the memory address is in a non-canonical form. If memory operand is not aligned on a 16-byte boundary, regardless of segment.
#PF(fault-code)	For a page fault.
#NM	If CR0.TS[bit 3] = 1.
#UD	If CR0.EM[bit 2] = 1. If CR4.OSFXSR[bit 9] = 0. If CPUID.SSE3(ECX, bit 0) is 0. If the LOCK prefix is used.

MOVSLDUP—Move Packed Single-FP Low and Duplicate

Opcode	Instruction	64-Bit Mode	Compat/ Leg Mode	Description
F3 0F 12 /r	MOVSLDUP <i>xmm1</i> , <i>xmm2/m128</i>	Valid	Valid	Move two single-precision floating-point values from the lower 32-bit operand of each qword in <i>xmm2/m128</i> to <i>xmm1</i> and duplicate each 32-bit operand to the higher 32-bits of each qword.

Description

The linear address corresponds to the address of the least-significant byte of the referenced memory data. When a memory address is indicated, the 16 bytes of data at memory location *m128* are loaded and the single-precision elements in positions 0 and 2 are duplicated. When the register-register form of this operation is used, the same operation is performed but with data coming from the 128-bit source register.

See Figure 3-17.

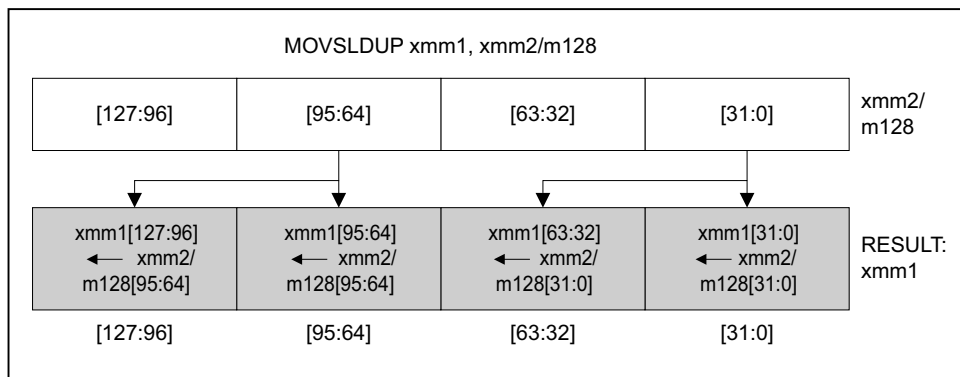

OM15999

Figure 3-17. MOVSLDUP—Move Packed Single-FP Low and Duplicate

In 64-bit mode, use of the REX.R prefix permits this instruction to access additional registers (XMM8-XMM15).

Operation

```

IF (Source == m128)
    THEN (* Load instruction *)
        xmm1[31:0] = m128[31:0];
        xmm1[63:32] = m128[31:0];
        xmm1[95:64] = m128[95:64];
        xmm1[127:96] = m128[95:64];
    ELSE (* Move instruction *)
        xmm1[31:0] = xmm2[31:0];
        xmm1[63:32] = xmm2[31:0];
        xmm1[95:64] = xmm2[95:64];
        xmm1[127:96] = xmm2[95:64];
FI;

```

Intel C/C++ Compiler Intrinsic Equivalent

```
MOVSLDUP    __m128 _mm_moveldup_ps(__m128 a)
```

Exceptions

General protection exception if not aligned on 16-byte boundary, regardless of segment.

Numeric Exceptions

None.

Protected Mode Exceptions

#GP(0)	For an illegal memory operand effective address in the CS, DS, ES, FS or GS segments. If memory operand is not aligned on a 16-byte boundary, regardless of segment.
#SS(0)	For an illegal address in the SS segment.
#PF(fault-code)	For a page fault.
#NM	If CR0.TS[bit 3] = 1.
#UD	If CR0.EM[bit 2] = 1. If CR4.OSFXSR[bit 9] = 0. If CPUID.01H: ECX.SSE3[bit 0] = 0. If the LOCK prefix is used.

Real Address Mode Exceptions

GP(0)	If any part of the operand would lie outside of the effective address space from 0 to 0FFFFH. If memory operand is not aligned on a 16-byte boundary, regardless of segment.
#NM	If CR0.TS[bit 3] = 1. If CR0.TS[bit 3] = 1.
#UD	If CR0.EM[bit 2] = 1. If CR4.OSFXSR[bit 9] = 0. If CPUID.01H: ECX.SSE3[bit 0] = 0. If the LOCK prefix is used.

Virtual 8086 Mode Exceptions

GP(0)	If any part of the operand would lie outside of the effective address space from 0 to 0FFFFH. If memory operand is not aligned on a 16-byte boundary, regardless of segment.
#NM	If CR0.TS[bit 3] = 1.
#UD	If CR0.EM[bit 2] = 1. If CR4.OSFXSR[bit 9] = 0. If CPUID.01H: ECX.SSE3[bit 0] = 0. If the LOCK prefix is used.
#PF(fault-code)	For a page fault.

Compatibility Mode Exceptions

Same exceptions as in protected mode.

64-Bit Mode Exceptions

#SS(0)	If a memory address referencing the SS segment is in a non-canonical form.
#GP(0)	If the memory address is in a non-canonical form. If memory operand is not aligned on a 16-byte boundary, regardless of segment.
#PF(fault-code)	For a page fault.
#NM	If CR0.TS[bit 3] = 1.
#UD	If CR0.EM[bit 2] = 1. If CR4.OSFXSR[bit 9] = 0. If CPUID.SSE3(ECX, bit 0) is 0. If the LOCK prefix is used.

MOVSS—Move Scalar Single-Precision Floating-Point Values

Opcode	Instruction	64-Bit Mode	Compat/ Leg Mode	Description
F3 0F 10 /r	MOVSS <i>xmm1</i> , <i>xmm2/m32</i>	Valid	Valid	Move scalar single-precision floating-point value from <i>xmm2/m32</i> to <i>xmm1</i> register.
F3 0F 11 /r	MOVSS <i>xmm2/m32</i> , <i>xmm</i>	Valid	Valid	Move scalar single-precision floating-point value from <i>xmm1</i> register to <i>xmm2/m32</i> .

Description

Moves a scalar single-precision floating-point value from the source operand (second operand) to the destination operand (first operand). The source and destination operands can be XMM registers or 32-bit memory locations. This instruction can be used to move a single-precision floating-point value to and from the low doubleword of an XMM register and a 32-bit memory location, or to move a single-precision floating-point value between the low doublewords of two XMM registers. The instruction cannot be used to transfer data between memory locations.

When the source and destination operands are XMM registers, the three high-order doublewords of the destination operand remain unchanged. When the source operand is a memory location and destination operand is an XMM registers, the three high-order doublewords of the destination operand are cleared to all 0s.

In 64-bit mode, use of the REX.R prefix permits this instruction to access additional registers (XMM8-XMM15).

Operation

MOVSS instruction when source and destination operands are XMM registers:

```
DEST[31:0] ← SRC[31:0];
(* DEST[127:32] remains unchanged *)
```

MOVSS instruction when source operand is XMM register and destination operand is memory location:

```
DEST ← SRC[31:0];
```

MOVSS instruction when source operand is memory location and destination operand is XMM register:

```
DEST[31:0] ← SRC;
DEST[127:32] ← 000000000000000000000000H;
```

Intel C/C++ Compiler Intrinsic Equivalent

```
MOVSS    __m128 _mm_load_ss(float * p)
```

MOVSS void _mm_store_ss(float * p, __m128 a)
 MOVSS __m128 _mm_move_ss(__m128 a, __m128 b)

SIMD Floating-Point Exceptions

None.

Protected Mode Exceptions

#GP(0) For an illegal memory operand effective address in the CS, DS, ES, FS or GS segments.

#SS(0) For an illegal address in the SS segment.

#PF(fault-code) For a page fault.

#NM If CR0.TS[bit 3] = 1.

#UD If CR0.EM[bit 2] = 1.
 If CR4.OSFXSR[bit 9] = 0.
 If CPUID.01H: EDX.SSE[bit 25] = 0.
 If the LOCK prefix is used.

#AC(0) If alignment checking is enabled and an unaligned memory reference is made while the current privilege level is 3.

Real-Address Mode Exceptions

GP If any part of the operand lies outside the effective address space from 0 to FFFFH.

#NM If CR0.TS[bit 3] = 1.

#UD If CR0.EM[bit 2] = 1.
 If CR4.OSFXSR[bit 9] = 0.
 If CPUID.01H: EDX.SSE[bit 25] = 0.
 If the LOCK prefix is used.

Virtual-8086 Mode Exceptions

Same exceptions as in real address mode.

#PF(fault-code) For a page fault.

#AC(0) If alignment checking is enabled and an unaligned memory reference is made.

Compatibility Mode Exceptions

Same exceptions as in protected mode.

64-Bit Mode Exceptions

#SS(0)	If a memory address referencing the SS segment is in a non-canonical form.
#GP(0)	If the memory address is in a non-canonical form.
#PF(fault-code)	For a page fault.
#NM	If CR0.TS[bit 3] = 1.
#UD	If CR0.EM[bit 2] = 1. If CR4.OSFXSR[bit 9] = 0. If CPUID.01H: EDX.SSE[bit 25] = 0. If the LOCK prefix is used.
#AC(0)	If alignment checking is enabled and an unaligned memory reference is made while the current privilege level is 3.

MOVSX/MOVSXD—Move with Sign-Extension

Opcode	Instruction	64-Bit Mode	Compat/Leg Mode	Description
OF BE /r	MOVSX r16, r/m8	Valid	Valid	Move byte to word with sign-extension.
OF BE /r	MOVSX r32, r/m8	Valid	Valid	Move byte to doubleword with sign-extension.
REX + OF BE /r	MOVSX r64, r/m8*	Valid	N.E.	Move byte to quadword with sign-extension.
OF BF /r	MOVSX r32, r/m16	Valid	Valid	Move word to doubleword, with sign-extension.
REX.W + OF BF /r	MOVSX r64, r/m16	Valid	N.E.	Move word to quadword with sign-extension.
REX.W** + 63 /r	MOVSXD r64, r/m32	Valid	N.E.	Move doubleword to quadword with sign-extension.

NOTES:

- * In 64-bit mode, r/m8 can not be encoded to access the following byte registers if a REX prefix is used: AH, BH, CH, DH.
- ** The use of MOVSXD without REX.W in 64-bit mode is discouraged, Regular MOV should be used instead of using MOVSXD without REX.W.

Description

Copies the contents of the source operand (register or memory location) to the destination operand (register) and sign extends the value to 16 or 32 bits (see Figure 7-6 in the *Intel® 64 and IA-32 Architectures Software Developer's Manual, Volume 1*). The size of the converted value depends on the operand-size attribute.

In 64-bit mode, the instruction's default operation size is 32 bits. Use of the REX.R prefix permits access to additional registers (R8-R15). Use of the REX.W prefix promotes operation to 64 bits. See the summary chart at the beginning of this section for encoding data and limits.

Operation

DEST ← SignExtend(SRC);

Flags Affected

None.

Protected Mode Exceptions

#GP(0)	If a memory operand effective address is outside the CS, DS, ES, FS, or GS segment limit. If the DS, ES, FS, or GS register contains a NULL segment selector.
#SS(0)	If a memory operand effective address is outside the SS segment limit.
#PF(fault-code)	If a page fault occurs.
#AC(0)	If alignment checking is enabled and an unaligned memory reference is made while the current privilege level is 3.
#UD	If the LOCK prefix is used.

Real-Address Mode Exceptions

#GP	If a memory operand effective address is outside the CS, DS, ES, FS, or GS segment limit.
#SS	If a memory operand effective address is outside the SS segment limit.
#UD	If the LOCK prefix is used.

Virtual-8086 Mode Exceptions

#GP(0)	If a memory operand effective address is outside the CS, DS, ES, FS, or GS segment limit.
#SS(0)	If a memory operand effective address is outside the SS segment limit.
#PF(fault-code)	If a page fault occurs.
#UD	If the LOCK prefix is used.

Compatibility Mode Exceptions

Same exceptions as in protected mode.

64-Bit Mode Exceptions

#SS(0)	If a memory address referencing the SS segment is in a non-canonical form.
#GP(0)	If the memory address is in a non-canonical form.
#PF(fault-code)	If a page fault occurs.
#AC(0)	If alignment checking is enabled and an unaligned memory reference is made while the current privilege level is 3.
#UD	If the LOCK prefix is used.

MOVUPD—Move Unaligned Packed Double-Precision Floating-Point Values

Opcode	Instruction	64-Bit Mode	Compat/ Leg Mode	Description
66 0F 10 /r	MOVUPD <i>xmm1</i> , <i>xmm2/m128</i>	Valid	Valid	Move packed double-precision floating-point values from <i>xmm2/m128</i> to <i>xmm1</i> .
66 0F 11 /r	MOVUPD <i>xmm2/m128, xmm</i>	Valid	Valid	Move packed double-precision floating-point values from <i>xmm1</i> to <i>xmm2/m128</i> .

Description

Moves a double quadword containing two packed double-precision floating-point values from the source operand (second operand) to the destination operand (first operand). This instruction can be used to load an XMM register from a 128-bit memory location, store the contents of an XMM register into a 128-bit memory location, or move data between two XMM registers. When the source or destination operand is a memory operand, the operand may be unaligned on a 16-byte boundary without causing a general-protection exception (#GP) to be generated.

To move double-precision floating-point values to and from memory locations that are known to be aligned on 16-byte boundaries, use the MOVAPD instruction.

While executing in 16-bit addressing mode, a linear address for a 128-bit data access that overlaps the end of a 16-bit segment is not allowed and is defined as reserved behavior. A specific processor implementation may or may not generate a general-protection exception (#GP) in this situation, and the address that spans the end of the segment may or may not wrap around to the beginning of the segment.

In 64-bit mode, use of the REX.R prefix permits this instruction to access additional registers (XMM8-XMM15).

Operation

DEST ← SRC;

Intel C/C++ Compiler Intrinsic Equivalent

MOVUPD `__m128 _mm_loadu_pd(double * p)`

MOVUPD `void _mm_storeu_pd(double *p, __m128 a)`

SIMD Floating-Point Exceptions

None.

Protected Mode Exceptions

#AC(0)	If alignment checking is enabled and an unaligned memory reference is made.
#GP(0)	For an illegal memory operand effective address in the CS, DS, ES, FS or GS segments.
#SS(0)	For an illegal address in the SS segment.
#PF(fault-code)	For a page fault.
#NM	If CR0.TS[bit 3] = 1.
#UD	If CR0.EM[bit 2] = 1. If CR4.OSFXSR[bit 9] = 0. If CPUID.01H:EDX.SSE2[bit 26] = 0. If the LOCK prefix is used.

Real-Address Mode Exceptions

GP	If any part of the operand lies outside the effective address space from 0 to FFFFH.
#NM	If CR0.TS[bit 3] = 1.
#UD	If CR0.EM[bit 2] = 1. If CR4.OSFXSR[bit 9] = 0. If CPUID.01H:EDX.SSE2[bit 26] = 0. If the LOCK prefix is used.

Virtual-8086 Mode Exceptions

Same exceptions as in real address mode.

#AC(0)	If alignment checking is enabled and an unaligned memory reference is made.
#PF(fault-code)	For a page fault.

Compatibility Mode Exceptions

Same exceptions as in protected mode.

64-Bit Mode Exceptions

#AC(0)	If alignment checking is enabled and an unaligned memory reference is made.
#SS(0)	If a memory address referencing the SS segment is in a non-canonical form.
#GP(0)	If the memory address is in a non-canonical form.
#PF(fault-code)	For a page fault.
#NM	If CR0.TS[bit 3] = 1.

#UD

If CR0.EM[bit 2] = 1.

If CR4.OSFXSR[bit 9] = 0.

If CPUID.01H:EDX.SSE2[bit 26] = 0.

If the LOCK prefix is used.

MOVUPS—Move Unaligned Packed Single-Precision Floating-Point Values

Opcode	Instruction	64-Bit Mode	Compat/Leg Mode	Description
OF 10 /r	MOVUPS <i>xmm1</i> , <i>xmm2/m128</i>	Valid	Valid	Move packed single-precision floating-point values from <i>xmm2/m128</i> to <i>xmm1</i> .
OF 11 /r	MOVUPS <i>xmm2/m128</i> , <i>xmm1</i>	Valid	Valid	Move packed single-precision floating-point values from <i>xmm1</i> to <i>xmm2/m128</i> .

Description

Moves a double quadword containing four packed single-precision floating-point values from the source operand (second operand) to the destination operand (first operand). This instruction can be used to load an XMM register from a 128-bit memory location, store the contents of an XMM register into a 128-bit memory location, or move data between two XMM registers. When the source or destination operand is a memory operand, the operand may be unaligned on a 16-byte boundary without causing a general-protection exception (#GP) to be generated.

To move packed single-precision floating-point values to and from memory locations that are known to be aligned on 16-byte boundaries, use the MOVAPS instruction.

While executing in 16-bit addressing mode, a linear address for a 128-bit data access that overlaps the end of a 16-bit segment is not allowed and is defined as reserved behavior. A specific processor implementation may or may not generate a general-protection exception (#GP) in this situation, and the address that spans the end of the segment may or may not wrap around to the beginning of the segment.

In 64-bit mode, use of the REX.R prefix permits this instruction to access additional registers (XMM8-XMM15).

Operation

DEST ← SRC;

Intel C/C++ Compiler Intrinsic Equivalent

MOVUPS `__m128 _mm_loadu_ps(double * p)`

MOVUPS `void _mm_storeu_ps(double *p, __m128 a)`

SIMD Floating-Point Exceptions

None.

Protected Mode Exceptions

#AC(0)	If alignment checking is enabled and an unaligned memory reference is made.
#GP(0)	For an illegal memory operand effective address in the CS, DS, ES, FS or GS segments.
#SS(0)	For an illegal address in the SS segment.
#PF(fault-code)	For a page fault.
#NM	If CR0.TS[bit 3] = 1.
#UD	If CR0.EM[bit 2] = 1. If CR4.OSFXSR[bit 9] = 0. If CPUID.01H:EDX.SSE[bit 25] = 0. If the LOCK prefix is used.

Real-Address Mode Exceptions

GP	If any part of the operand lies outside the effective address space from 0 to FFFFH.
#NM	If CR0.TS[bit 3] = 1.
#UD	If CR0.EM[bit 2] = 1. If CR4.OSFXSR[bit 9] = 0. If CPUID.01H:EDX.SSE[bit 25] = 0. If the LOCK prefix is used.

Virtual-8086 Mode Exceptions

Same exceptions as in real address mode.

#AC(0)	If alignment checking is enabled and an unaligned memory reference is made.
#PF(fault-code)	For a page fault.

Compatibility Mode Exceptions

Same exceptions as in protected mode.

64-Bit Mode Exceptions

#AC(0)	If alignment checking is enabled and an unaligned memory reference is made.
#SS(0)	If a memory address referencing the SS segment is in a non-canonical form.
#GP(0)	If the memory address is in a non-canonical form.
#PF(fault-code)	For a page fault.
#NM	If CR0.TS[bit 3] = 1.

#UD

If CR0.EM[bit 2] = 1.

If CR4.OSFXSR[bit 9] = 0.

If CPUID.01H:EDX.SSE[bit 25] = 0.

If the LOCK prefix is used.

MOVZX—Move with Zero-Extend

Opcode	Instruction	64-Bit Mode	Compat/Leg Mode	Description
OF B6 /r	MOVZX <i>r16, r/m8</i>	Valid	Valid	Move byte to word with zero-extension.
OF B6 /r	MOVZX <i>r32, r/m8</i>	Valid	Valid	Move byte to doubleword, zero-extension.
REX.W + OF B6 /r	MOVZX <i>r64, r/m8*</i>	Valid	N.E.	Move byte to quadword, zero-extension.
OF B7 /r	MOVZX <i>r32, r/m16</i>	Valid	Valid	Move word to doubleword, zero-extension.
REX.W + OF B7 /r	MOVZX <i>r64, r/m16</i>	Valid	N.E.	Move word to quadword, zero-extension.

NOTES:

- * In 64-bit mode, *r/m8* can not be encoded to access the following byte registers if the REX prefix is used: AH, BH, CH, DH.

Description

Copies the contents of the source operand (register or memory location) to the destination operand (register) and zero extends the value. The size of the converted value depends on the operand-size attribute.

In 64-bit mode, the instruction's default operation size is 32 bits. Use of the REX.R prefix permits access to additional registers (R8-R15). Use of the REX.W prefix promotes operation to 64 bit operands. See the summary chart at the beginning of this section for encoding data and limits.

Operation

DEST ← ZeroExtend(SRC);

Flags Affected

None.

Protected Mode Exceptions

- #GP(0) If a memory operand effective address is outside the CS, DS, ES, FS, or GS segment limit.
If the DS, ES, FS, or GS register contains a NULL segment selector.

#SS(0)	If a memory operand effective address is outside the SS segment limit.
#PF(fault-code)	If a page fault occurs.
#AC(0)	If alignment checking is enabled and an unaligned memory reference is made while the current privilege level is 3.
#UD	If the LOCK prefix is used.

Real-Address Mode Exceptions

#GP	If a memory operand effective address is outside the CS, DS, ES, FS, or GS segment limit.
#SS	If a memory operand effective address is outside the SS segment limit.
#UD	If the LOCK prefix is used.

Virtual-8086 Mode Exceptions

#GP(0)	If a memory operand effective address is outside the CS, DS, ES, FS, or GS segment limit.
#SS(0)	If a memory operand effective address is outside the SS segment limit.
#PF(fault-code)	If a page fault occurs.
#AC(0)	If alignment checking is enabled and an unaligned memory reference is made.
#UD	If the LOCK prefix is used.

Compatibility Mode Exceptions

Same exceptions as in protected mode.

64-Bit Mode Exceptions

#SS(0)	If a memory address referencing the SS segment is in a non-canonical form.
#GP(0)	If the memory address is in a non-canonical form.
#PF(fault-code)	If a page fault occurs.
#AC(0)	If alignment checking is enabled and an unaligned memory reference is made while the current privilege level is 3.
#UD	If the LOCK prefix is used.

MPSADBW — Compute Multiple Packed Sums of Absolute Difference

Opcode	Instruction	64-bit Mode	Compat/ Leg Mode	Description
66 OF 3A 42 /r ib	MPSADBW <i>xmm1</i> , <i>xmm2/m128</i> <i>8, imm8</i>	Valid	Valid	Sums absolute 8-bit integer difference of adjacent groups of 4 byte integers in <i>xmm1</i> and <i>xmm2/m128</i> and writes the results in <i>xmm1</i> . Starting offsets within <i>xmm1</i> and <i>xmm2/m128</i> are determined by <i>imm8</i> .

Description

MPSADBW sums the absolute difference (SAD) of a pair of unsigned bytes for a group of 4 byte pairs, and produces 8 SAD results (one for each 4 byte-pairs) stored as 8 word integers in the destination operand (first operand). Each 4 byte pairs are selected from the source operand (first operand) and the destination according to the bit fields specified in the immediate byte (third operand).

The immediate byte provides two bit fields:

SRC_OFFSET: the value of $\text{Imm8}[1:0] * 32$ specifies the offset of the 4 sequential source bytes in the source operand.

DEST_OFFSET: the value of $\text{Imm8}[2] * 32$ specifies the offset of the first of 8 groups of 4 sequential destination bytes in the destination operand. The next four destination bytes starts at $\text{DEST_OFFSET} + 8$, etc.

The SAD operation is repeated 8 times, each time using the same 4 source bytes but selecting the next group of 4 destination bytes starting at the next higher byte in the destination. Each 16-bit sum is written to destination.

Operation

$\text{SRC_OFFSET} \leftarrow \text{imm8}[1:0] * 32$

$\text{DEST_OFFSET} \leftarrow \text{imm8}[2] * 32$

$\text{DEST_BYTE0} \leftarrow \text{DEST}[\text{DEST_OFFSET}+7:\text{DEST_OFFSET}]$

$\text{DEST_BYTE1} \leftarrow \text{DEST}[\text{DEST_OFFSET}+15:\text{DEST_OFFSET}+8]$

$\text{DEST_BYTE2} \leftarrow \text{DEST}[\text{DEST_OFFSET}+23:\text{DEST_OFFSET}+16]$

$\text{DEST_BYTE3} \leftarrow \text{DEST}[\text{DEST_OFFSET}+31:\text{DEST_OFFSET}+24]$

$\text{DEST_BYTE4} \leftarrow \text{DEST}[\text{DEST_OFFSET}+39:\text{DEST_OFFSET}+32]$

$\text{DEST_BYTE5} \leftarrow \text{DEST}[\text{DEST_OFFSET}+47:\text{DEST_OFFSET}+40]$

$\text{DEST_BYTE6} \leftarrow \text{DEST}[\text{DEST_OFFSET}+55:\text{DEST_OFFSET}+48]$

$\text{DEST_BYTE7} \leftarrow \text{DEST}[\text{DEST_OFFSET}+63:\text{DEST_OFFSET}+56]$

$\text{DEST_BYTE8} \leftarrow \text{DEST}[\text{DEST_OFFSET}+71:\text{DEST_OFFSET}+64]$

$\text{DEST_BYTE9} \leftarrow \text{DEST}[\text{DEST_OFFSET}+79:\text{DEST_OFFSET}+72]$

DEST_BYTE10 ← DEST[DEST_OFFSET+87:DEST_OFFSET+80]

SRC_BYTE0 ← SRC[SRC_OFFSET+7:SRC_OFFSET]
 SRC_BYTE1 ← SRC[SRC_OFFSET+15:SRC_OFFSET+8]
 SRC_BYTE2 ← SRC[SRC_OFFSET+23:SRC_OFFSET+16]
 SRC_BYTE3 ← SRC[SRC_OFFSET+31:SRC_OFFSET+24]

TEMP0 ← ABS(DEST_BYTE0 - SRC_BYTE0)
 TEMP1 ← ABS(DEST_BYTE1 - SRC_BYTE1)
 TEMP2 ← ABS(DEST_BYTE2 - SRC_BYTE2)
 TEMP3 ← ABS(DEST_BYTE3 - SRC_BYTE3)
 DEST[15:0] ← TEMP0 + TEMP1 + TEMP2 + TEMP3

TEMP0 ← ABS(DEST_BYTE1 - SRC_BYTE0)
 TEMP1 ← ABS(DEST_BYTE2 - SRC_BYTE1)
 TEMP2 ← ABS(DEST_BYTE3 - SRC_BYTE2)
 TEMP3 ← ABS(DEST_BYTE4 - SRC_BYTE3)
 DEST[31:16] ← TEMP0 + TEMP1 + TEMP2 + TEMP3

TEMP0 ← ABS(DEST_BYTE2 - SRC_BYTE0)
 TEMP1 ← ABS(DEST_BYTE3 - SRC_BYTE1)
 TEMP2 ← ABS(DEST_BYTE4 - SRC_BYTE2)
 TEMP3 ← ABS(DEST_BYTE5 - SRC_BYTE3)
 DEST[47:32] ← TEMP0 + TEMP1 + TEMP2 + TEMP3

TEMP0 ← ABS(DEST_BYTE3 - SRC_BYTE0)
 TEMP1 ← ABS(DEST_BYTE4 - SRC_BYTE1)
 TEMP2 ← ABS(DEST_BYTE5 - SRC_BYTE2)
 TEMP3 ← ABS(DEST_BYTE6 - SRC_BYTE3)
 DEST[63:48] ← TEMP0 + TEMP1 + TEMP2 + TEMP3

TEMP0 ← ABS(DEST_BYTE4 - SRC_BYTE0)
 TEMP1 ← ABS(DEST_BYTE5 - SRC_BYTE1)
 TEMP2 ← ABS(DEST_BYTE6 - SRC_BYTE2)
 TEMP3 ← ABS(DEST_BYTE7 - SRC_BYTE3)
 DEST[79:64] ← TEMP0 + TEMP1 + TEMP2 + TEMP3

TEMP0 ← ABS(DEST_BYTE5 - SRC_BYTE0)
 TEMP1 ← ABS(DEST_BYTE6 - SRC_BYTE1)
 TEMP2 ← ABS(DEST_BYTE7 - SRC_BYTE2)
 TEMP3 ← ABS(DEST_BYTE8 - SRC_BYTE3)
 DEST[95:80] ← TEMP0 + TEMP1 + TEMP2 + TEMP3

$TEMP0 \leftarrow ABS(DEST_BYTE6 - SRC_BYTE0)$
 $TEMP1 \leftarrow ABS(DEST_BYTE7 - SRC_BYTE1)$
 $TEMP2 \leftarrow ABS(DEST_BYTE8 - SRC_BYTE2)$
 $TEMP3 \leftarrow ABS(DEST_BYTE9 - SRC_BYTE3)$
 $DEST[111:96] \leftarrow TEMP0 + TEMP1 + TEMP2 + TEMP3$

$TEMP0 \leftarrow ABS(DEST_BYTE7 - SRC_BYTE0)$
 $TEMP1 \leftarrow ABS(DEST_BYTE8 - SRC_BYTE1)$
 $TEMP2 \leftarrow ABS(DEST_BYTE9 - SRC_BYTE2)$
 $TEMP3 \leftarrow ABS(DEST_BYTE10 - SRC_BYTE3)$
 $DEST[127:112] \leftarrow TEMP0 + TEMP1 + TEMP2 + TEMP3$

Intel C/C++ Compiler Intrinsic Equivalent

MPSADBw `__m128i_mm_mpsadbw_epu8 (__m128i s1, __m128i s2, const int mask);`

Flags Affected

None

Protected Mode Exceptions

#GP(0) For an illegal memory operand effective address in the CS, DS, ES, FS, or GS segments.
 If a memory operand is not aligned on a 16-byte boundary, regardless of segment.

#SS(0) For an illegal address in the SS segment.

#PF(fault-code) For a page fault.

#NM If CR0.TS[bit 3] = 1.

#UD If CR0.EM[bit 2] = 1.
 If CR4.OSFXSR[bit 9] = 0.
 If CPUID.01H:ECX.SSE4_1[bit 19] = 0.
 If LOCK prefix is used.
 Either the prefix REP (F3h) or REPN (F2H) is used.

Real Mode Exceptions

#GP(0) if any part of the operand lies outside of the effective address space from 0 to 0FFFFH.
 If a memory operand is not aligned on a 16-byte boundary, regardless of segment.

#NM If CR0.TS[bit 3] = 1.

#UD If CR0.EM[bit 2] = 1.

If CR4.OSFXSR[bit 9] = 0.
 If CPUID.01H: ECX.SSE4_1[bit 19] = 0.
 If LOCK prefix is used.
 Either the prefix REP (F3h) or REPN (F2H) is used.

Virtual 8086 Mode Exceptions

Same exceptions as in Real Address Mode.

#PF(fault-code) For a page fault.

Compatibility Mode Exceptions

Same exceptions as in Protected Mode.

64-Bit Mode Exceptions

#GP(0) If the memory address is in a non-canonical form.
 If a memory operand is not aligned on a 16-byte boundary, regardless of segment.

#SS(0) If a memory address referencing the SS segment is in a non-canonical form.

#PF(fault-code) For a page fault.

#NM If TS in CR0 is set.

#UD If EM in CR0 is set.
 If OSFXSR in CR4 is 0.
 If CPUID feature flag ECX.SSE4_1 is 0.
 If LOCK prefix is used.
 Either the prefix REP (F3h) or REPN (F2H) is used.

MUL—Unsigned Multiply

Opcode	Instruction	64-Bit Mode	Compat/Leg Mode	Description
F6 /4	MUL <i>r/m8</i>	Valid	Valid	Unsigned multiply ($AX \leftarrow AL * r/m8$).
REX + F6 /4	MUL <i>r/m8</i> *	Valid	N.E.	Unsigned multiply ($AX \leftarrow AL * r/m8$).
F7 /4	MUL <i>r/m16</i>	Valid	Valid	Unsigned multiply ($DX:AX \leftarrow AX * r/m16$).
F7 /4	MUL <i>r/m32</i>	Valid	Valid	Unsigned multiply ($EDX:EAX \leftarrow EAX * r/m32$).
REX.W + F7 /4	MUL <i>r/m64</i>	Valid	N.E.	Unsigned multiply ($RDX:RAX \leftarrow RAX * r/m64$).

NOTES:

- * In 64-bit mode, *r/m8* can not be encoded to access the following byte registers if a REX prefix is used: AH, BH, CH, DH.

Description

Performs an unsigned multiplication of the first operand (destination operand) and the second operand (source operand) and stores the result in the destination operand. The destination operand is an implied operand located in register AL, AX or EAX (depending on the size of the operand); the source operand is located in a general-purpose register or a memory location. The action of this instruction and the location of the result depends on the opcode and the operand size as shown in Table 3-69.

The result is stored in register AX, register pair DX:AX, or register pair EDX:EAX (depending on the operand size), with the high-order bits of the product contained in register AH, DX, or EDX, respectively. If the high-order bits of the product are 0, the CF and OF flags are cleared; otherwise, the flags are set.

In 64-bit mode, the instruction's default operation size is 32 bits. Use of the REX.R prefix permits access to additional registers (R8-R15). Use of the REX.W prefix promotes operation to 64 bits.

See the summary chart at the beginning of this section for encoding data and limits.

Table 3-69. MUL Results

Operand Size	Source 1	Source 2	Destination
Byte	AL	<i>r/m8</i>	AX
Word	AX	<i>r/m16</i>	DX:AX
Doubleword	EAX	<i>r/m32</i>	EDX:EAX
Quadword	RAX	<i>r/m64</i>	RDX:RAX

Operation

```

IF (Byte operation)
  THEN
    AX ← AL * SRC;
  ELSE (* Word or doubleword operation *)
    IF OperandSize = 16
      THEN
        DX:AX ← AX * SRC;
      ELSE IF OperandSize = 32
        THEN EDX:EAX ← EAX * SRC; FI;
      ELSE (* OperandSize = 64 *)
        RDX:RAX ← RAX * SRC;
    FI;
  FI;

```

Flags Affected

The OF and CF flags are set to 0 if the upper half of the result is 0; otherwise, they are set to 1. The SF, ZF, AF, and PF flags are undefined.

Protected Mode Exceptions

#GP(0)	If a memory operand effective address is outside the CS, DS, ES, FS, or GS segment limit. If the DS, ES, FS, or GS register contains a NULL segment selector.
#SS(0)	If a memory operand effective address is outside the SS segment limit.
#PF(fault-code)	If a page fault occurs.
#AC(0)	If alignment checking is enabled and an unaligned memory reference is made while the current privilege level is 3.
#UD	If the LOCK prefix is used.

Real-Address Mode Exceptions

#GP	If a memory operand effective address is outside the CS, DS, ES, FS, or GS segment limit.
#SS	If a memory operand effective address is outside the SS segment limit.
#UD	If the LOCK prefix is used.

Virtual-8086 Mode Exceptions

#GP(0)	If a memory operand effective address is outside the CS, DS, ES, FS, or GS segment limit.
--------	-------------------------------------------------------------------------------------------

#SS(0)	If a memory operand effective address is outside the SS segment limit.
#PF(fault-code)	If a page fault occurs.
#AC(0)	If alignment checking is enabled and an unaligned memory reference is made.
#UD	If the LOCK prefix is used.

Compatibility Mode Exceptions

Same exceptions as in protected mode.

64-Bit Mode Exceptions

#SS(0)	If a memory address referencing the SS segment is in a non-canonical form.
#GP(0)	If the memory address is in a non-canonical form.
#PF(fault-code)	If a page fault occurs.
#AC(0)	If alignment checking is enabled and an unaligned memory reference is made while the current privilege level is 3.

MULPD—Multiply Packed Double-Precision Floating-Point Values

Opcode	Instruction	64-Bit Mode	Compat/ Leg Mode	Description
66 0F 59 /r	MULPD <i>xmm1</i> , <i>xmm2/m128</i>	Valid	Valid	Multiply packed double-precision floating-point values in <i>xmm2/m128</i> by <i>xmm1</i> .

Description

Performs a SIMD multiply of the two packed double-precision floating-point values from the source operand (second operand) and the destination operand (first operand), and stores the packed double-precision floating-point results in the destination operand. The source operand can be an XMM register or a 128-bit memory location. The destination operand is an XMM register. See Figure 11-3 in the *Intel® 64 and IA-32 Architectures Software Developer's Manual, Volume 1*, for an illustration of a SIMD double-precision floating-point operation.

In 64-bit mode, use of the REX.R prefix permits this instruction to access additional registers (XMM8-XMM15).

Operation

```
DEST[63:0] ← DEST[63:0] * SRC[63:0];
DEST[127:64] ← DEST[127:64] * SRC[127:64];
```

Intel C/C++ Compiler Intrinsic Equivalent

```
MULPD    __m128d _mm_mul_pd (m128d a, m128d b)
```

SIMD Floating-Point Exceptions

Overflow, Underflow, Invalid, Precision, Denormal.

Protected Mode Exceptions

#GP(0)	For an illegal memory operand effective address in the CS, DS, ES, FS or GS segments.
	If a memory operand is not aligned on a 16-byte boundary, regardless of segment.
#SS(0)	For an illegal address in the SS segment.
#PF(fault-code)	For a page fault.
#NM	If CR0.TS[bit 3] = 1.
#XM	If an unmasked SIMD floating-point exception and CR4.OSXMMEXCPT[bit 10] = 1.

#UD If an unmasked SIMD floating-point exception and CR4.OSXMMEXCPT[bit 10] = 0.
 If CR0.EM[bit 2] = 1.
 If CR4.OSFXSR[bit 9] = 0.
 If CPUID.01H:EDX.SSE2[bit 26] = 0.
 If the LOCK prefix is used.

Real-Address Mode Exceptions

#GP If a memory operand is not aligned on a 16-byte boundary, regardless of segment.
 If any part of the operand lies outside the effective address space from 0 to FFFFH.

#NM If CR0.TS[bit 3] = 1.

#XM If an unmasked SIMD floating-point exception and CR4.OSXMMEXCPT[bit 10] = 1.

#UD If an unmasked SIMD floating-point exception and CR4.OSXMMEXCPT[bit 10] = 0.
 If CR0.EM[bit 2] = 1.
 If CR4.OSFXSR[bit 9] = 0.
 If CPUID.01H:EDX.SSE2[bit 26] = 0.
 If the LOCK prefix is used.

Virtual-8086 Mode Exceptions

Same exceptions as in real address mode.

#PF(fault-code) For a page fault.

Compatibility Mode Exceptions

Same exceptions as in protected mode.

64-Bit Mode Exceptions

#SS(0) If a memory address referencing the SS segment is in a non-canonical form.

#GP(0) If the memory address is in a non-canonical form.
 If memory operand is not aligned on a 16-byte boundary, regardless of segment.

#PF(fault-code) For a page fault.

#NM If CR0.TS[bit 3] = 1.

#XM If an unmasked SIMD floating-point exception and CR4.OSXMMEXCPT[bit 10] = 1.

#UD

If an unmasked SIMD floating-point exception and CR4.OSXMMEXCPT[bit 10] = 0.

If CR0.EM[bit 2] = 1.

If CR4.OSFXSR[bit 9] = 0.

If CPUID.01H:EDX.SSE2[bit 26] = 0.

If the LOCK prefix is used.

MULPS—Multiply Packed Single-Precision Floating-Point Values

Opcode	Instruction	64-Bit Mode	Compat/Leg Mode	Description
OF 59 /r	MULPS <i>xmm1</i> , <i>xmm2/mem128</i>	Valid	Valid	Multiply packed single-precision floating-point values in <i>xmm2/mem</i> by <i>xmm1</i> .

Description

Performs a SIMD multiply of the four packed single-precision floating-point values from the source operand (second operand) and the destination operand (first operand), and stores the packed single-precision floating-point results in the destination operand. The source operand can be an XMM register or a 128-bit memory location. The destination operand is an XMM register. See Figure 10-5 in the *Intel® 64 and IA-32 Architectures Software Developer's Manual, Volume 1*, for an illustration of a SIMD single-precision floating-point operation.

In 64-bit mode, use of the REX.R prefix permits this instruction to access additional registers (XMM8-XMM15).

Operation

```
DEST[31:0] ← DEST[31:0] * SRC[31:0];
DEST[63:32] ← DEST[63:32] * SRC[63:32];
DEST[95:64] ← DEST[95:64] * SRC[95:64];
DEST[127:96] ← DEST[127:96] * SRC[127:96];
```

Intel C/C++ Compiler Intrinsic Equivalent

```
MULPS    __m128 _mm_mul_ps(__m128 a, __m128 b)
```

SIMD Floating-Point Exceptions

Overflow, Underflow, Invalid, Precision, Denormal.

Protected Mode Exceptions

#GP(0)	For an illegal memory operand effective address in the CS, DS, ES, FS or GS segments. If a memory operand is not aligned on a 16-byte boundary, regardless of segment.
#SS(0)	For an illegal address in the SS segment.
#PF(fault-code)	For a page fault.
#NM	If CR0.TS[bit 3] = 1.

#XM	If an unmasked SIMD floating-point exception and CR4.OSXMMEXCPT[bit 10] = 1.
#UD	If an unmasked SIMD floating-point exception and CR4.OSXMMEXCPT[bit 10] = 0. If CR0.EM[bit 2] = 1. If CR4.OSFXSR[bit 9] = 0. If CPUID.01H: EDX.SSE[bit 25] = 0. If the LOCK prefix is used.

Real-Address Mode Exceptions

#GP	If a memory operand is not aligned on a 16-byte boundary, regardless of segment. If any part of the operand lies outside the effective address space from 0 to FFFFH.
#NM	If CR0.TS[bit 3] = 1.
#XM	If an unmasked SIMD floating-point exception and CR4.OSXMMEXCPT[bit 10] = 1.
#UD	If an unmasked SIMD floating-point exception and CR4.OSXMMEXCPT[bit 10] = 0. If CR0.EM[bit 2] = 1. If CR4.OSFXSR[bit 9] = 0. If CPUID.01H: EDX.SSE[bit 25] = 0. If the LOCK prefix is used.

Virtual-8086 Mode Exceptions

Same exceptions as in real address mode.

#PF(fault-code) For a page fault.

Compatibility Mode Exceptions

Same exceptions as in protected mode.

64-Bit Mode Exceptions

#SS(0)	If a memory address referencing the SS segment is in a non-canonical form.
#GP(0)	If the memory address is in a non-canonical form. If memory operand is not aligned on a 16-byte boundary, regardless of segment.
#PF(fault-code)	For a page fault.
#NM	If CR0.TS[bit 3] = 1.

#XM	If an unmasked SIMD floating-point exception and CR4.OSXMMEXCPT[bit 10] = 1.
#UD	If an unmasked SIMD floating-point exception and CR4.OSXMMEXCPT[bit 10] = 0. If CR0.EM[bit 2] = 1. If CR4.OSFXSR[bit 9] = 0. If CPUID.01H: EDX.SSE[bit 25] = 0. If the LOCK prefix is used.

MULSD—Multiply Scalar Double-Precision Floating-Point Values

Opcode	Instruction	64-Bit Mode	Compat/Leg Mode	Description
F2 0F 59 /r	MULSD <i>xmm1</i> , <i>xmm2/m64</i>	Valid	Valid	Multiply the low double-precision floating-point value in <i>xmm2/mem64</i> by low double-precision floating-point value in <i>xmm1</i> .

Description

Multiplies the low double-precision floating-point value in the source operand (second operand) by the low double-precision floating-point value in the destination operand (first operand), and stores the double-precision floating-point result in the destination operand. The source operand can be an XMM register or a 64-bit memory location. The destination operand is an XMM register. The high quadword of the destination operand remains unchanged. See Figure 11-4 in the *Intel® 64 and IA-32 Architectures Software Developer's Manual, Volume 1*, for an illustration of a scalar double-precision floating-point operation.

In 64-bit mode, use of the REX.R prefix permits this instruction to access additional registers (XMM8-XMM15).

Operation

DEST[63:0] ← DEST[63:0] * xmm2/m64[63:0];
(* DEST[127:64] unchanged *)

Intel C/C++ Compiler Intrinsic Equivalent

MULSD __m128d _mm_mul_sd (m128d a, m128d b)

SIMD Floating-Point Exceptions

Overflow, Underflow, Invalid, Precision, Denormal.

Protected Mode Exceptions

#GP(0)	For an illegal memory operand effective address in the CS, DS, ES, FS or GS segments.
#SS(0)	For an illegal address in the SS segment.
#PF(fault-code)	For a page fault.
#NM	If CR0.TS[bit 3] = 1.
#XM	If an unmasked SIMD floating-point exception and CR4.OSXMMEXCPT[bit 10] = 1.

#UD	<p>If an unmasked SIMD floating-point exception and CR4.OSXMMEXCPT[bit 10] = 0.</p> <p>If CR0.EM[bit 2] = 1.</p> <p>If CR4.OSFXSR[bit 9] = 0.</p> <p>If CPUID.01H:EDX.SSE2[bit 26] = 0.</p> <p>If the LOCK prefix is used.</p>
#AC(0)	<p>If alignment checking is enabled and an unaligned memory reference is made while the current privilege level is 3.</p>

Real-Address Mode Exceptions

#GP	<p>If any part of the operand lies outside the effective address space from 0 to FFFFH.</p>
#NM	<p>If CR0.TS[bit 3] = 1.</p>
#XM	<p>If an unmasked SIMD floating-point exception and CR4.OSXMMEXCPT[bit 10] = 1.</p>
#UD	<p>If an unmasked SIMD floating-point exception and CR4.OSXMMEXCPT[bit 10] = 0.</p> <p>If CR0.EM[bit 2] = 1.</p> <p>If CR4.OSFXSR[bit 9] = 0.</p> <p>If CPUID.01H:EDX.SSE2[bit 26] = 0.</p> <p>If the LOCK prefix is used.</p>

Virtual-8086 Mode Exceptions

Same exceptions as in real address mode.

#PF(fault-code)	For a page fault.
#AC	For unaligned memory reference.

Compatibility Mode Exceptions

Same exceptions as in protected mode.

64-Bit Mode Exceptions

#SS(0)	<p>If a memory address referencing the SS segment is in a non-canonical form.</p>
#GP(0)	<p>If the memory address is in a non-canonical form.</p>
#PF(fault-code)	For a page fault.
#NM	<p>If CR0.TS[bit 3] = 1.</p>
#XM	<p>If an unmasked SIMD floating-point exception and CR4.OSXMMEXCPT[bit 10] = 1.</p>

#UD	If an unmasked SIMD floating-point exception and CR4.OSXMMEXCPT[bit 10] = 0. If CR0.EM[bit 2] = 1. If CR4.OSFXSR[bit 9] = 0. If CPUID.01H:EDX.SSE2[bit 26] = 0. If the LOCK prefix is used.
#AC(0)	If alignment checking is enabled and an unaligned memory reference is made while the current privilege level is 3.

MULSS—Multiply Scalar Single-Precision Floating-Point Values

Opcode	Instruction	64-Bit Mode	Compat/ Leg Mode	Description
F3 0F 59 /r	MULSS <i>xmm1</i> , <i>xmm2/m32</i>	Valid	Valid	Multiply the low single-precision floating-point value in <i>xmm2/mem</i> by the low single-precision floating-point value in <i>xmm1</i> .

Description

Multiplies the low single-precision floating-point value from the source operand (second operand) by the low single-precision floating-point value in the destination operand (first operand), and stores the single-precision floating-point result in the destination operand. The source operand can be an XMM register or a 32-bit memory location. The destination operand is an XMM register. The three high-order double-words of the destination operand remain unchanged. See Figure 10-6 in the *Intel® 64 and IA-32 Architectures Software Developer's Manual, Volume 1*, for an illustration of a scalar single-precision floating-point operation.

In 64-bit mode, use of the REX.R prefix permits this instruction to access additional registers (XMM8-XMM15).

Operation

DEST[31:0] ← DEST[31:0] * SRC[31:0];
(* DEST[127:32] unchanged *)

Intel C/C++ Compiler Intrinsic Equivalent

MULSS __m128 _mm_mul_ss(__m128 a, __m128 b)

SIMD Floating-Point Exceptions

Overflow, Underflow, Invalid, Precision, Denormal.

Protected Mode Exceptions

#GP(0)	For an illegal memory operand effective address in the CS, DS, ES, FS or GS segments.
#SS(0)	For an illegal address in the SS segment.
#PF(fault-code)	For a page fault.
#NM	If CRO.TS[bit 3] = 1.
#XM	If an unmasked SIMD floating-point exception and CR4.OSXMMEXCPT[bit 10] = 1.

#UD	If an unmasked SIMD floating-point exception and CR4.OSXMMEXCPT[bit 10] = 0. If CR0.EM[bit 2] = 1. If CR4.OSFXSR[bit 9] = 0. If CPUID.01H:EDX.SSE[bit 25] = 0. If the LOCK prefix is used.
#AC(0)	If alignment checking is enabled and an unaligned memory reference is made while the current privilege level is 3.

Real-Address Mode Exceptions

#GP	If any part of the operand lies outside the effective address space from 0 to FFFFH.
#NM	If CR0.TS[bit 3] = 1.
#XM	If an unmasked SIMD floating-point exception and CR4.OSXMMEXCPT[bit 10] = 1.
#UD	If an unmasked SIMD floating-point exception and CR4.OSXMMEXCPT[bit 10] = 0. If CR0.EM[bit 2] = 1. If CR4.OSFXSR[bit 9] = 0. If CPUID.01H:EDX.SSE[bit 25] = 0. If the LOCK prefix is used.

Virtual-8086 Mode Exceptions

Same exceptions as in real address mode.

#PF(fault-code)	For a page fault.
#AC	For unaligned memory reference.

Compatibility Mode Exceptions

Same exceptions as in protected mode.

64-Bit Mode Exceptions

#SS(0)	If a memory address referencing the SS segment is in a non-canonical form.
#GP(0)	If the memory address is in a non-canonical form.
#PF(fault-code)	For a page fault.
#NM	If CR0.TS[bit 3] = 1.
#XM	If an unmasked SIMD floating-point exception and CR4.OSXMMEXCPT[bit 10] = 1.

#UD	<p>If an unmasked SIMD floating-point exception and CR4.OSXMMEXCPT[bit 10] = 0.</p> <p>If CR0.EM[bit 2] = 1.</p> <p>If CR4.OSFXSR[bit 9] = 0.</p> <p>If CPUID.01H: EDX.SSE[bit 25] = 0.</p> <p>If the LOCK prefix is used.</p>
#AC(0)	<p>If alignment checking is enabled and an unaligned memory reference is made while the current privilege level is 3.</p>

MWAIT—Monitor Wait

Opcode	Instruction	64-Bit Mode	Compat/ Leg Mode	Description
0F 01 C9	MWAIT	Valid	Valid	A hint that allow the processor to stop instruction execution and enter an implementation-dependent optimized state until occurrence of a class of events.

Description

MWAIT instruction provides hints to allow the processor to enter an implementation-dependent optimized state. There are two principal targeted usages: address-range monitor and advanced power management. Both usages of MWAIT require the use of the MONITOR instruction.

A CPUID feature flag (ECX bit 3; CPUID executed EAX = 1) indicates the availability of MONITOR and MWAIT in the processor. When set, MWAIT may be executed only at privilege level 0 (use at any other privilege level results in an invalid-opcode exception). The operating system or system BIOS may disable this instruction by using the IA32_MISC_ENABLE MSR; disabling MWAIT clears the CPUID feature flag and causes execution to generate an illegal opcode exception.

This instruction's operation is the same in non-64-bit modes and 64-bit mode.

MWAIT for Address Range Monitoring

For address-range monitoring, the MWAIT instruction operates with the MONITOR instruction. The two instructions allow the definition of an address at which to wait (MONITOR) and a implementation-dependent-optimized operation to commence at the wait address (MWAIT). The execution of MWAIT is a hint to the processor that it can enter an implementation-dependent-optimized state while waiting for an event or a store operation to the address range armed by MONITOR.

ECX specifies optional extensions for the MWAIT instruction. EAX may contain hints such as the preferred optimized state the processor should enter.

For Pentium 4 processors (CPUID signature family 15 and model 3), non-zero values for EAX and ECX are reserved. Later processors defined ECX=1 as a valid extension (see below).

A store to the address range armed by the MONITOR instruction, an interrupt, an NMI or SMI, a debug exception, a machine check exception, the BINIT# signal, the INIT# signal, or the RESET# signal will exit the implementation-dependent-optimized state. An interrupt will cause the processor to exit only if the state was entered with interrupts enabled or if ECX=1.

If a store to the address range causes the processor to exit, execution will resume at the instruction following the MWAIT instruction. If an interrupt (including NMI) caused the processor to exit the implementation-dependent-optimized state, the

processor will exit the state and handle the interrupt. If an SMI caused the processor to exit the implementation-dependent-optimized state, execution will resume at the instruction following MWAIT after handling of the SMI. Unlike the HLT instruction, the MWAIT instruction does not support a restart at the MWAIT instruction. There may also be other implementation-dependent events or time-outs that may take the processor out of the implementation-dependent-optimized state and resume execution at the instruction following the MWAIT.

If the preceding MONITOR instruction did not successfully arm an address range or if the MONITOR instruction has not been executed prior to executing MWAIT, then the processor will not enter the implementation-dependent-optimized state. Execution will resume at the instruction following the MWAIT.

MWAIT for Power Management

MWAIT accepts a hint and optional extension to the processor that it can enter a specified target C state while waiting for an event or a store operation to the address range armed by MONITOR. Support for MWAIT extensions for power management is indicated by CPUID.05H.ECX[0] reporting 1.

EAX and ECX will be used to communicate the additional information to the MWAIT instruction, such as the kind of optimized state the processor should enter. ECX specifies optional extensions for the MWAIT instruction. EAX may contain hints such as the preferred optimized state the processor should enter. A given processor implementation may choose to ignore the hint and continue executing the next instruction. Future processor implementations may implement several optimized “waiting” states and will select among those states based on the hint argument.

Table 3-70 describes the meaning of ECX and EAX registers for MWAIT extensions.

Table 3-70. MWAIT Extension Register (ECX)

Bits	Description
0	Treat Interrupt as break-event, even when interrupts are disabled (EFLAGS.IF=0). May be set only if CPUID.01H:ECX.MONITOR[bit 3] = 1.
31: 1	Reserved

Table 3-71. MWAIT Hints Register (EAX)

Bits	Description
3 : 0	Sub C-state within a C-state, indicated by bits [7:4]
7 : 4	Target C-state* Value of 0 means C1; 1 means C2 and so on Value of 01111B means C0 Note: Target C states for MWAIT extensions are processor-specific C-states, not ACPI C-states
31: 8	Reserved

Note that if MWAIT is used to enter any of the C-states that are numerically higher than C1, a store to the address range armed by the MONITOR instruction will cause the processor to exit MWAIT only if the store was originated by other processor agents. A store from non-processor agent may not cause the processor to exit MWAIT in such cases

For additional details of MWAIT extensions, see Chapter 14, “Power and Thermal Management,” of *Intel® 64 and IA-32 Architectures Software Developer’s Manual, Volume 3A*.

Operation

(* MWAIT takes the argument in EAX as a hint extension and is architected to take the argument in ECX as an instruction extension MWAIT EAX, ECX *)

```
{
WHILE ( ("Monitor Hardware is in armed state")) {
    implementation_dependent_optimized_state(EAX, ECX);
Set the state of Monitor Hardware as triggered;
}
```

Intel C/C++ Compiler Intrinsic Equivalent

```
MWAIT    void _mm_mwait(unsigned extensions, unsigned hints)
```

Example

MONITOR/MWAIT instruction pair must be coded in the same loop because execution of the MWAIT instruction will trigger the monitor hardware. It is not a proper usage to execute MONITOR once and then execute MWAIT in a loop. Setting up MONITOR without executing MWAIT has no adverse effects.

Typically the MONITOR/MWAIT pair is used in a sequence, such as:

```
EAX = Logical Address(Trigger)
ECX = 0 (*Hints *)
```

EDX = 0 (* Hints *)

```

IF ( !trigger_store_happened ) {
    MONITOR EAX, ECX, EDX
    IF ( !trigger_store_happened ) {
        MWAIT EAX, ECX
    }
}

```

The above code sequence makes sure that a triggering store does not happen between the first check of the trigger and the execution of the monitor instruction. Without the second check that triggering store would go un-noticed. Typical usage of MONITOR and MWAIT would have the above code sequence within a loop.

Numeric Exceptions

None

Protected Mode Exceptions

#GP(0) If ECX[31:1] ≠ 0.
 If ECX[0] = 1 and CPUID.05H:ECX[bit 3] = 0.

#UD If CPUID.01H:ECX.MONITOR[bit 3] = 0.
 If current privilege level is not 0.

Real Address Mode Exceptions

#GP If ECX[31:1] ≠ 0.
 If ECX[0] = 1 and CPUID.05H:ECX[bit 3] = 0.

#UD If CPUID.01H:ECX.MONITOR[bit 3] = 0.

Virtual 8086 Mode Exceptions

#UD The MWAIT instruction is not recognized in virtual-8086 mode (even if CPUID.01H:ECX.MONITOR[bit 3] = 1).

Compatibility Mode Exceptions

Same exceptions as in protected mode.

64-Bit Mode Exceptions

#GP(0) If RCX[63:1] ≠ 0.
 If RCX[0] = 1 and CPUID.05H:ECX[bit 3] = 0.

#UD If the current privilege level is not 0.
 If CPUID.01H:ECX.MONITOR[bit 3] = 0.